

carolus 

PRAXIS-PLANER[®] 2009

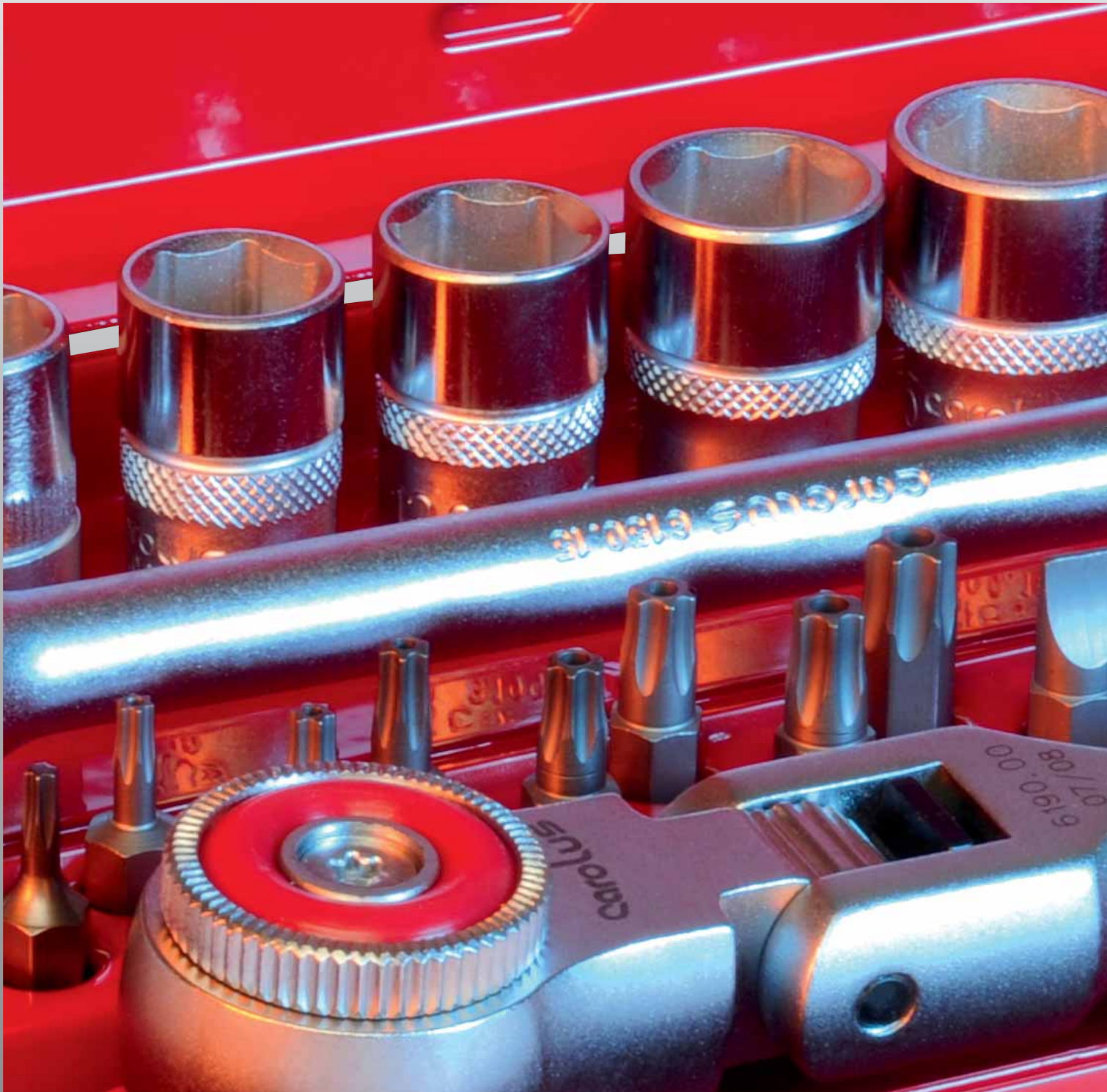

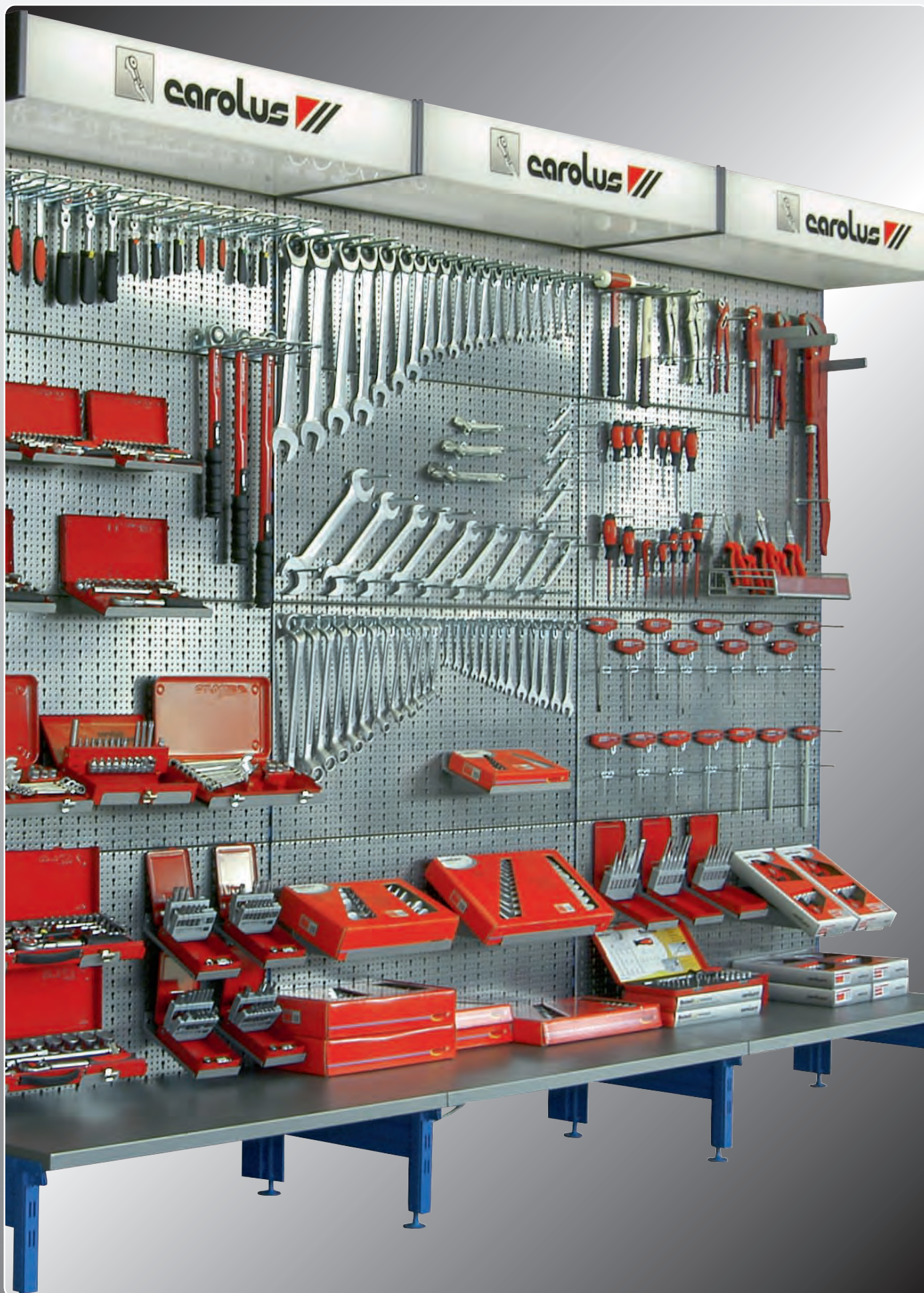

1/4" 3/8"
1/2" 5/16"
3/4"



4-10 1

1/4" 3/8"
1/2" 5/16"
3/4"

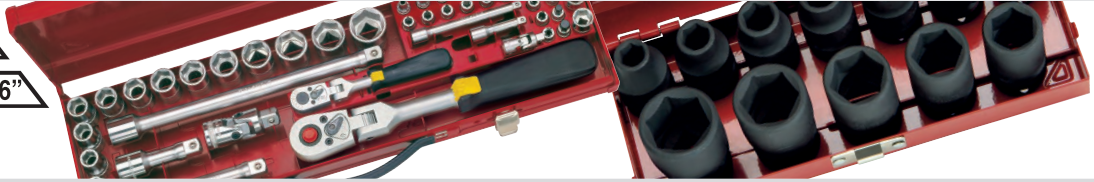

11-38 2

1/4" 3/8"
1/2" 5/16"
3/4"



39-55 3



56-58 4



59-68 5



69-80 6



81-84 7



85-88 8



89-95 9

1

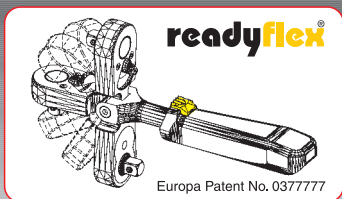

1/4"	6.3	Code 1519654	Art.-No. 7225.00	mm 140	g 130
------	-----	-----------------	----------------------------	-----------	----------

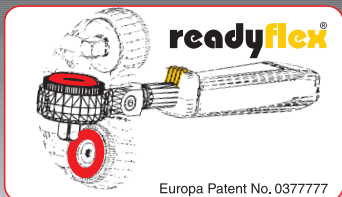
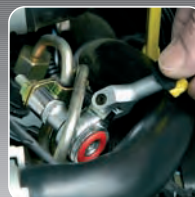

1/4"	6.3	Code 1519778	Art.-No. 7290.30	mm 135	g 134
------	-----	-----------------	----------------------------	-----------	----------

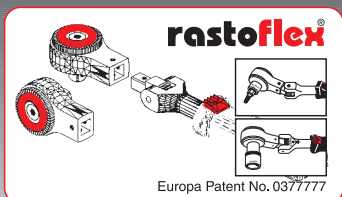

1/4"	6.3	Code 1519441	Art.-No. 7200.35	mm 150	g 148
------	-----	-----------------	----------------------------	-----------	----------

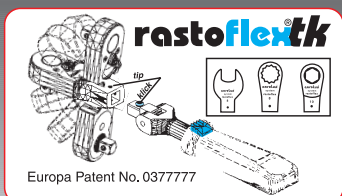

1/4"	6.3	Code 1519743	Art.-No. 7270.25tk	mm 150	g 144
------	-----	-----------------	------------------------------	-----------	----------

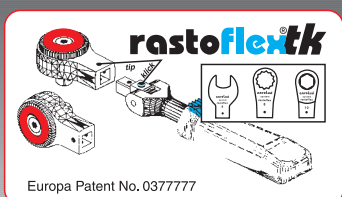

1/4"	6.3	Code 1519468	Art.-No. 7200.35tk	mm 150	g 148
------	-----	-----------------	------------------------------	-----------	----------



1/4"	6.3	Code 1515314	Art.-No. 4177.20	mm 120	g 90
------	-----	-----------------	----------------------------	-----------	---------



1/4"	6.3	Code 1519379	Art.-No. 7190.30	mm 120	g 100
------	-----	-----------------	----------------------------	-----------	----------

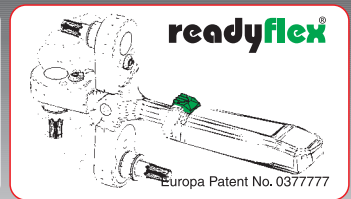

1/4"	6.3	Code 1519662	Art.-No. 7226.00	mm 140	g 130
------	-----	-----------------	----------------------------	-----------	----------

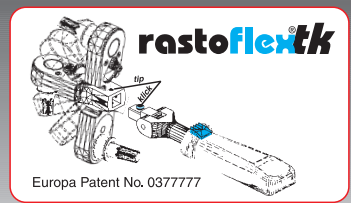

1/4"	6.3	Code 1519751	Art.-No. 7270.26tk	mm 150	g 144
------	-----	-----------------	------------------------------	-----------	----------



1/4"	6.3	Code 1515438	Art.-No. 4177.26	mm 120	g 90
------	-----	-----------------	----------------------------	-----------	---------

1

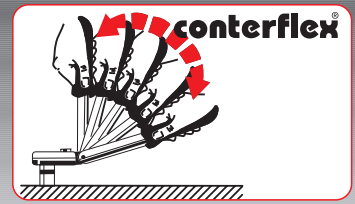

3/8"	10	Code	Art.-No.	mm	g
		1517856	6125.00	225	430



3/8"	10	Code	Art.-No.	mm	g
		1518011	6190.00	225	410

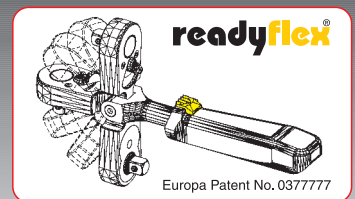
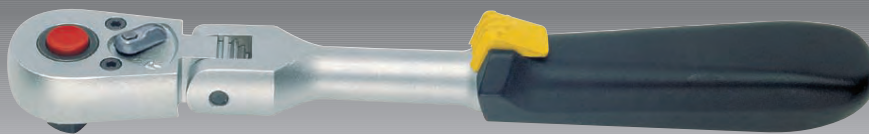

3/8"	10	Code	Art.-No.	mm	g
		1696556	6225.00	225	440

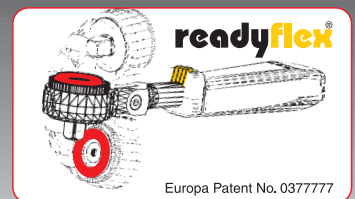
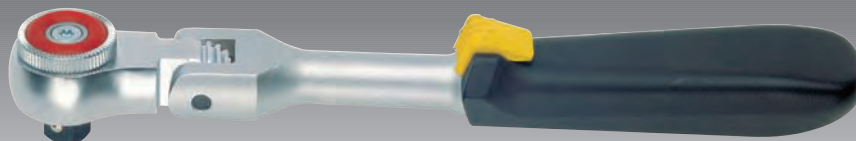

3/8"	10	Code	Art.-No.	mm	g
		1696572	6290.00	225	420



3/8"

carolus

1



3/8"	10	Code 1518038	Art.-No. 6190.20	mm 210	mm 300
------	----	-----------------	----------------------------	-----------	-----------



3/8"	10	Code 1518046	Art.-No. 6190.30	mm 210	mm 230
------	----	-----------------	----------------------------	-----------	-----------



1

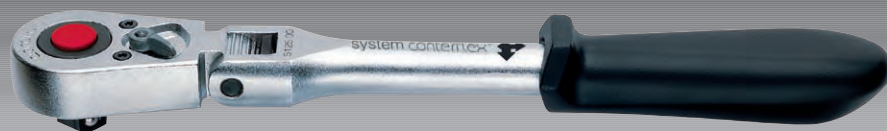

1/2"	12,5	Code	Art.-No.	mm	g
		1516590	5125.00	270	730



1/2"	12,5	Code	Art.-No.	mm	g
		1516671	5190.00	260	650

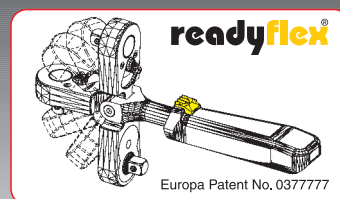

1/2"	12,5	Code	Art.-No.	mm	g
		1696041	5225.00	270	740

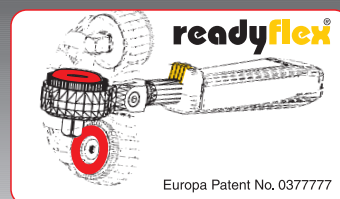
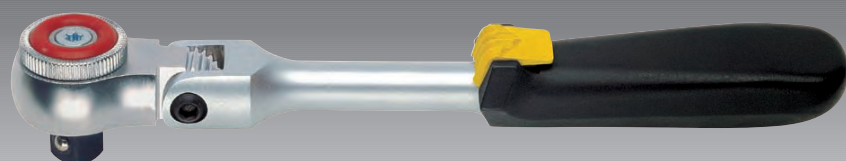

1/2"	12,5	Code	Art.-No.	mm	g
		1696068	5290.00	260	660

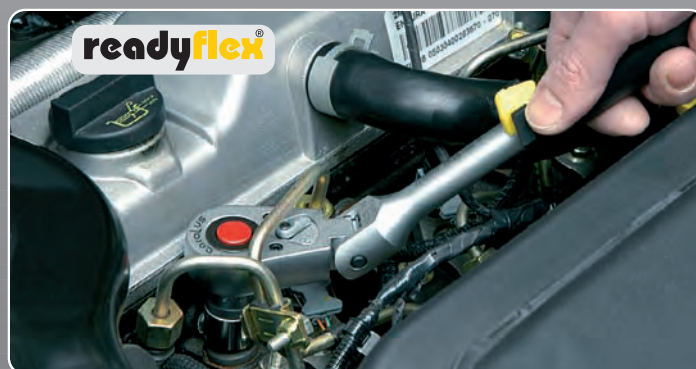

1/2"

carolus

1

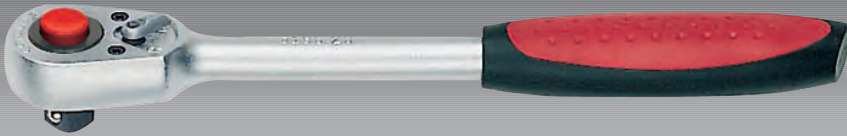

1/2"	12.5	Code 1516698	Art.-No. 5190.20	mm 280	g 580
------	------	-----------------	----------------------------	-----------	----------



1/2"	12.5	Code 1516701	Art.-No. 5190.30	mm 280	g 526
------	------	-----------------	----------------------------	-----------	----------



1/2"	12.5	Code 1920995	Art.-No. 5170.00	mm 270	g 520
------	------	-----------------	----------------------------	-----------	----------



1



3/4"	20	Code	Art.-No.	↔ mm	⚖
		1683500	8170.00	510	1300



5/16"



5/16"	8	Code	Art.-No.	↔ mm	⚖
		1517864	6126.00	225	425



5/16"	8	Code	Art.-No.	↔ mm	⚖
		1518062	6190.40	210	290

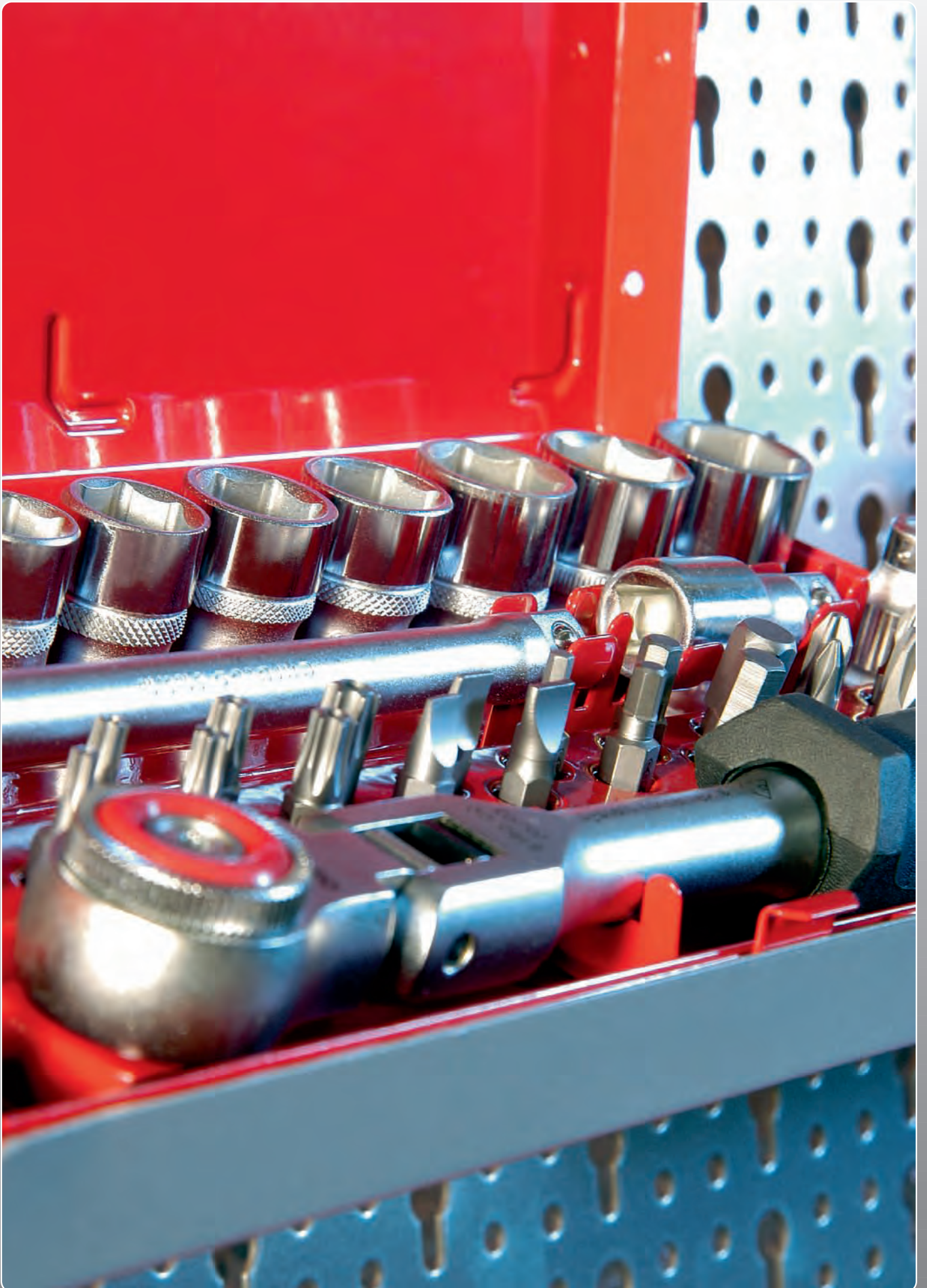

2



- 4 - 4,5 - 5 - 5,5 - 6 - 7 - 8 - 9 - 10 - 11 - 12 - 13 mm
- 4 - 5,5 - 6,5 mm
- PH 0 - 1 - 2 - 3
- 3 - 4 - 5 - 6 - 8 - 10 mm
- 50 / 100 mm
- 8 mm x 1/4"
- 1/4" ■ x 1/4" ●

1/4"	6,3	Code	Art.-No.	mm	g
		1514385	4004.85	200 x 110 x 30	1100



- 4 - 4,5 - 5 - 5,5 - 6 - 7 - 8 - 9 - 10 - 11 - 12 - 13 mm
- 4 - 5,5 - 6,5 mm
- PH 0 - 1 - 2 - 3
- 3 - 4 - 5 - 6 - 8 - 10 mm
- 50 / 100 mm
- 8 mm x 1/4"
- 1/4" ■ x 1/4" ●

1/4"	6,3	Code	Art.-No.	mm	g
		1514431	4004.90	200 x 110 x 30	1100



- 4 - 4,5 - 5 - 5,5 - 6 - 7 - 8 - 9 - 10 - 11 - 12 - 13 mm
- 4 - 5,5 - 6,5 mm
- PH 0 - 1 - 2 - 3
- 3 - 4 - 5 - 6 - 8 - 10 mm
- 50 / 100 mm
- 8 mm x 1/4"
- 1/4" ■ x 1/4" ●

1/4"	6,3	Code	Art.-No.	mm	g
		1514334	4004.80	200 x 110 x 30	1100



- 4 - 4,5 - 5 - 5,5 - 6 - 7 - 8 - 9 - 10 - 11 - 12 - 13 mm
- 4 - 5,5 - 6,5 mm
- PH 0 - 1 - 2 - 3
- 3 - 4 - 5 - 6 - 8 - 10 mm
- 50 / 100 mm
- 8 mm x 1/4"
- 1/4" ■ x 1/4" ●

1/4"	6,3	Code	Art.-No.	mm	g
		1514342	4004.80tk	200 x 110 x 30	1100

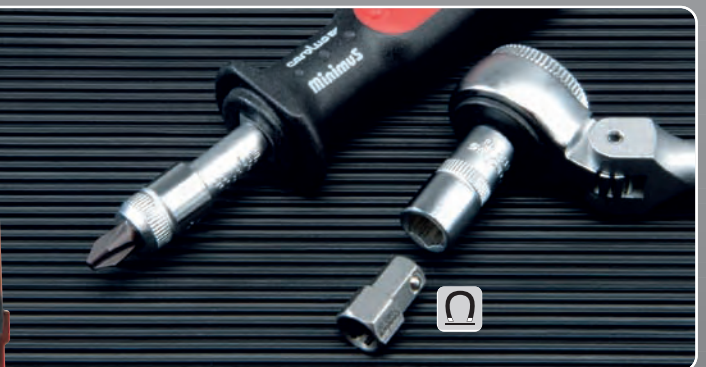



1/4"

carolus

2



- 4 - 4,5 - 5 - 5,5 - 6 - 7 - 8 - 9 - 10 - 11 - 12 - 13 mm
- TX10 - TX15 - TX20 - TX25 - TX27 - TX30 - TX40
- 3 - 4 - 5 - 6 - 8 - 10 mm
- 50 / 100 mm
- 8 mm x 1/4"

1/4"	6,3	Code 1514407	Art.-No. 4004.86	mm 200 x 110 x 30	g 1100
------	-----	-----------------	----------------------------	----------------------	-----------



- 4 - 4,5 - 5 - 5,5 - 6 - 7 - 8 - 9 - 10 - 11 - 12 - 13 mm
- TX10 - TX15 - TX20 - TX25 - TX27 - TX30 - TX40
- 3 - 4 - 5 - 6 - 8 - 10 mm
- 50 / 100 mm
- 8 mm x 1/4"

1/4"	6,3	Code 1514458	Art.-No. 4004.91	mm 200 x 110 x 30	g 1100
------	-----	-----------------	----------------------------	----------------------	-----------



- 4 - 4,5 - 5 - 5,5 - 6 - 7 - 8 - 9 - 10 - 11 - 12 - 13 mm
- TX10 - TX15 - TX20 - TX25 - TX27 - TX30 - TX40
- 3 - 4 - 5 - 6 - 8 - 10 mm
- 50 / 100 mm
- 8 mm x 1/4"

1/4"	6,3	Code 1514350	Art.-No. 4004.81	mm 200 x 110 x 30	g 1100
------	-----	-----------------	----------------------------	----------------------	-----------



- 4 - 4,5 - 5 - 5,5 - 6 - 7 - 8 - 9 - 10 - 11 - 12 - 13 mm
- TX10 - TX15 - TX20 - TX25 - TX27 - TX30 - TX40
- 3 - 4 - 5 - 6 - 8 - 10 mm
- 50 / 100 mm
- 8 mm x 1/4"

1/4"	6,3	Code 1514369	Art.-No. 4004.81tk	mm 200 x 110 x 30	g 1100
------	-----	-----------------	------------------------------	----------------------	-----------

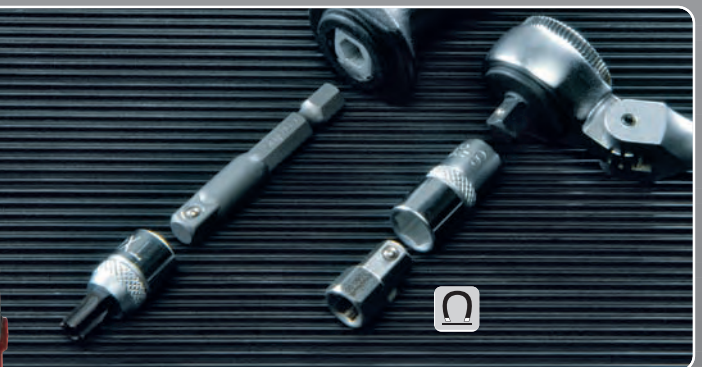

2

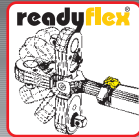

- 4 - 4,5 - 5 - 5,5 - 6 - 7 - 8 - 9 - 10 - 11 - 12 - 13 mm
- TX10 - TX15 - TX20 - TX25 - TX27 - TX30 - TX40
- 5,5 mm
- PH 2 PZ2
- 4 - 5 - 6 mm 2,5 / 3,5 0 / 1
- 50 / 100 mm 1/4" ■
- 8 mm x 1/4"
- 1/4" ■ x 1/4" ●

1/4"	6.3	Code	Art.-No.	mm	g
		1514377	4004.84	200 x 110 x 30	1100



- 4 - 4,5 - 5 - 5,5 - 6 - 7 - 8 - 9 - 10 - 11 - 12 - 13 mm
- TX10 - TX15 - TX20 - TX25 - TX27 - TX30 - TX40
- 5,5 mm
- PH 2 PZ2
- 4 - 5 - 6 mm 2,5 / 3,5 0 / 1
- 50 / 100 mm 1/4" ■
- 8 mm x 1/4"
- 1/4" ■ x 1/4" ●

1/4"	6.3	Code	Art.-No.	mm	g
		1514423	4004.89	200 x 110 x 30	1100



- 4 - 4,5 - 5 - 5,5 - 6 - 7 - 8 - 9 - 10 - 11 - 12 - 13 mm
- TX10 - TX15 - TX20 - TX25 - TX27 - TX30 - TX40
- 5,5 mm
- PH 2 PZ2
- 4 - 5 - 6 mm 2,5 / 3,5 0 / 1
- 50 / 100 mm 1/4" ■
- 8 mm x 1/4"
- 1/4" ■ x 1/4" ●

1/4"	6.3	Code	Art.-No.	mm	g
		1514415	4004.87	200 x 110 x 30	1100

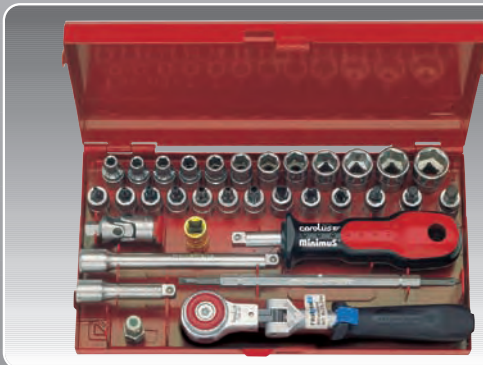

- 4 - 4,5 - 5 - 5,5 - 6 - 7 - 8 - 9 - 10 - 11 - 12 - 13 mm
- TX10 - TX15 - TX20 - TX25 - TX27 - TX30 - TX40
- 5,5 mm
- PH 2 PZ2
- 4 - 5 - 6 mm 2,5 / 3,5 0 / 1
- 50 / 100 mm 1/4" ■
- 8 mm x 1/4"
- 1/4" ■ x 1/4" ●

1/4"	6.3	Code	Art.-No.	mm	g
		1699423	4004.87tk	200 x 110 x 30	1100



PH 0 / 1 2,5 / 3,5 mm

1/4"



○ 8 - 9 - 10 - 11 - 12 - 13 mm

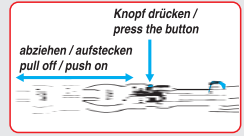

1/4"	6.3	Code	Art.-No.	mm	g
		1519174	7000.15tk	135 x 135 x 30	696



○ 8 - 9 - 10 - 11 - 12 - 13 mm

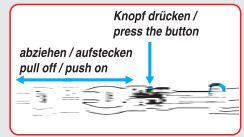

1/4"	6.3	Code	Art.-No.	mm	g
		1519182	7000.20tk	135 x 135 x 30	658



○ 8 - 9 - 10 - 11 - 12 - 13 mm

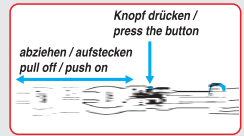

1/4"	6.3	Code	Art.-No.	mm	g
		1519204	7000.30tk	135 x 135 x 30	696



2



- 4 - 4,5 - 5 - 5,5 - 6 - 7 - 8 - 9 - 10 - 11 - 12 - 13 mm
- 4 - 5,5 - 6,5 mm
- PH 0 - 1 - 2 - 3
- 3 - 4 - 5 - 6 - 8 - 10 mm
- 50 / 100 mm
- 1/4" ■ x 1/4" ●

1/4"	6,3	Code	Art.-No.	mm	g
		1514288	4004.77	200 x 110 x 30	1080



5°
72 Zähne/Teeth

- 4 - 4,5 - 5 - 5,5 - 6 - 7 - 8 - 9 - 10 - 11 - 12 - 13 mm
- 4 - 5,5 - 6,5 mm
- PH 0 - 1 - 2 - 3
- 3 - 4 - 5 - 6 - 8 - 10 mm
- 50 / 100 mm
- 1/4" ■ x 1/4" ●

1/4"	6,3	Code	Art.-No.	mm	g
		1514504	4004.97	200 x 110 x 30	1080



- 4 - 4,5 - 5 - 5,5 - 6 - 7 - 8 - 9 - 10 - 11 - 12 - 13 mm
- 4 - 5,5 - 6,5 mm
- PH 0 - 1 - 2 - 3
- 3 - 4 - 5 - 6 - 8 - 10 mm
- 50 / 100 mm
- 8 mm x 1/4"
- 1/4" ■ x 1/4" ●

1/4"	6,3	Code	Art.-No.	mm	g
		1695940	4004.47	200 x 110 x 30	1080



5°
72 Zähne/Teeth

- 4 - 4,5 - 5 - 5,5 - 6 - 7 - 8 - 9 - 10 - 11 - 12 - 13 mm
- 4 - 5,5 - 6,5 mm
- PH 0 - 1 - 2 - 3
- 3 - 4 - 5 - 6 - 8 - 10 mm
- 50 / 100 mm
- 8 mm x 1/4"
- 1/4" ■ x 1/4" ●

1/4"	6,3	Code	Art.-No.	mm	g
		1695967	4004.57	200 x 110 x 30	1080



4004.77
4004.97



4004.47
4004.57

PH 0 / 1
2,5 / 3,5 mm





1/4"

carolus

2



- 4 - 4,5 - 5 - 5,5 - 6 - 7 - 8 - 9 - 10 - 11 - 12 - 13 mm
- TX10 - TX15 - TX20 - TX25 - TX27 - TX30 - TX40
- 3 - 4 - 5 - 6 - 8 - 10 mm
- 50 / 100 mm
- 1/4" ■ x 1/4" ●

1/4"	6.3	Code	Art.-No.	mm	1080
		1514326	4004.79	200 x 110 x 30	



5°
72 Zähne/Teeth

- 4 - 4,5 - 5 - 5,5 - 6 - 7 - 8 - 9 - 10 - 11 - 12 - 13 mm
- TX10 - TX15 - TX20 - TX25 - TX27 - TX30 - TX40
- 3 - 4 - 5 - 6 - 8 - 10 mm
- 50 / 100 mm
- 1/4" ■ x 1/4" ●

1/4"	6.3	Code	Art.-No.	mm	1080
		1514512	4004.99	200 x 110 x 30	



- 4 - 4,5 - 5 - 5,5 - 6 - 7 - 8 - 9 - 10 - 11 - 12 - 13 mm
- TX10 - TX15 - TX20 - TX25 - TX27 - TX30 - TX40
- 3 - 4 - 5 - 6 - 8 - 10 mm
- 50 / 100 mm
- 1/4" ■ x 1/4" ●
- 8 mm x 1/4" ⊖ 2,5 / 3,5
- ⊕ 0 / 1

1/4"	6.3	Code	Art.-No.	mm	1080
		1695959	4004.49	200 x 110 x 30	



5°
72 Zähne/Teeth

- 4 - 4,5 - 5 - 5,5 - 6 - 7 - 8 - 9 - 10 - 11 - 12 - 13 mm
- TX10 - TX15 - TX20 - TX25 - TX27 - TX30 - TX40
- 3 - 4 - 5 - 6 - 8 - 10 mm
- 50 / 100 mm
- 1/4" ■ x 1/4" ●
- 8 mm x 1/4" ⊖ 2,5 / 3,5
- ⊕ 0 / 1

1/4"	6.3	Code	Art.-No.	mm	1080
		1695975	4004.59	200 x 110 x 30	

4004.79
4004.99



4004.49
4004.59



PH 0 / 1 2,5 / 3,5 mm



2



5°
72 Zähne/Teeth

- 4 - 4,5 - 5 - 5,5 - 6 - 7 - 8 - 9 - 10 - 11 - 12 - 13 mm
- ⊕ TX10 - TX15 - TX20 - TX25 - TX27 - TX30 - TX40
- ⊖ 5,5 mm
- ⊕ PH 2 ⊕ PZ2 ○ 8 - 9 - 10 - 11 - 12 - 13 mm
- ⊖ 4 - 5 - 6 mm ⊖ 2,5 / 3,5 ⊕ 0 / 1
- ⊕ TX6 - TX7 - TX8 - TX9 - TX10 - TX15 - TX20 - TX25 - TX30 - TX40
- 50 / 100 mm ⊕ 1/4" ○ x 1/4" ●
- ⊖ 8 mm x 1/4"
- 1/4" ■ x 1/4" ●

1/4"	6.3	Code	Art.-No.	mm	
		1514032	4004.15	270 x 135 x 35	1956



5°
72 Zähne/Teeth

- 4 - 4,5 - 5 - 5,5 - 6 - 7 - 8 - 9 - 10 - 11 - 12 - 13 mm
- ⊕ TX10 - TX15 - TX20 - TX25 - TX27 - TX30 - TX40
- ⊖ 5,5 mm
- ⊕ PH 2 ⊕ PZ2 ○ 8 - 9 - 10 - 11 - 12 - 13 mm
- ⊖ 4 - 5 - 6 mm ⊖ 2,5 / 3,5 ⊕ 0 / 1
- ⊕ TX6 - TX7 - TX8 - TX9 - TX10 - TX15 - TX20 - TX25 - TX30 - TX40
- 50 / 100 mm ⊕ 1/4" ○ x 1/4" ●
- ⊖ 8 mm x 1/4"
- 1/4" ■ x 1/4" ●

1/4"	6.3	Code	Art.-No.	mm	
		1514113	4004.20	270 x 135 x 35	1918



5°
72 Zähne/Teeth

- 4 - 4,5 - 5 - 5,5 - 6 - 7 - 8 - 9 - 10 - 11 - 12 - 13 mm
- ⊕ TX10 - TX15 - TX20 - TX25 - TX27 - TX30 - TX40
- ⊖ 5,5 mm
- ⊕ PH 2 ⊕ PZ2 ○ 8 - 9 - 10 - 11 - 12 - 13 mm
- ⊖ 4 - 5 - 6 mm ⊖ 2,5 / 3,5 ⊕ 0 / 1
- ⊕ TX6 - TX7 - TX8 - TX9 - TX10 - TX15 - TX20 - TX25 - TX30 - TX40
- 50 / 100 mm ⊕ 1/4" ○ x 1/4" ●
- ⊖ 8 mm x 1/4"
- 1/4" ■ x 1/4" ●

1/4"	6.3	Code	Art.-No.	mm	
		1514121	4004.30	270 x 135 x 35	1904





1/4"

carolus



- 4 - 4,5 - 5 - 5,5 - 6 - 7 - 8 - 9 - 10 - 11 - 12 - 13 mm
- TX10 - TX15 - TX20 - TX25 - TX27 - TX27 - TX30 - TX40
- E5 - E6 - E7 - E8 - E10
- 50 / 100 mm
- 1/4" □ x 1/4" ○
- 1/4" ■ x 1/4" ●

1/4"	6.3	Code	Art.-No.	mm	
		1514253	4004.75	200 x 110 x 30	1100



5°
72 Zähne/Teeth

- 4 - 4,5 - 5 - 5,5 - 6 - 7 - 8 - 9 - 10 - 11 - 12 - 13 mm
- TX10 - TX15 - TX20 - TX25 - TX27 - TX27 - TX30 - TX40
- E5 - E6 - E7 - E8 - E10
- 50 / 100 mm
- 1/4" □ x 1/4" ○
- 1/4" ■ x 1/4" ●

1/4"	6.3	Code	Art.-No.	mm	
		1514148	4004.65	200 x 110 x 30	1100



1/4"



- 5 - 5,5 - 6 - 7 - 8 - 9 - 10 - 11 - 12 - 13 mm
- 50 mm
- 100 mm
- 1/4" □ x 1/4" ○

1/4"	6.3	Code	Art.-No.	mm	
		1516116	4500.00	135 x 135 x 30	758



5°
72 Zähne/Teeth

- 5 - 5,5 - 6 - 7 - 8 - 9 - 10 - 11 - 12 - 13 mm
- 50 mm
- 100 mm
- 1/4" □ x 1/4" ○

1/4"	6.3	Code	Art.-No.	mm	
		1516183	4590.00	135 x 135 x 30	758

2

ZOLL / Inches

2



ZOLL / Inches

- 3/16" - 7/32" - 1/4" - 9/32" - 5/16" - 11/32" - 3/8" - 13/32" - 7/16" - 1/2"
- 1/4" - 5/16"
- 1/8" - 5/32" - 3/16" - 1/4" - 5/16" - 7/32"
- ⊕ TX10 - TX15 - TX20 - TX25 - TX27 - TX30 - TX40
- ⊖ 50 / 100 mm
- 1/4" ■ x 1/4" ●

1/4"	6.3	Code	Art.-No.	mm	
		1514261	4004.76	200 x 110 x 30	1100



ZOLL / Inches

- 3/16" - 7/32" - 1/4" - 9/32" - 5/16" - 11/32" - 3/8" - 13/32" - 7/16" - 1/2"
- 1/4" - 5/16"
- 1/8" - 5/32" - 3/16" - 1/4" - 5/16" - 7/32"
- ⊖ 4 - 5,5 - 6,5
- ⊕ PH 0 - 1 - 2 - 3
- 50 / 100 mm
- 1/4" ■ x 1/4" ●

1/4"	6.3	Code	Art.-No.	mm	
		1514318	4004.78	200 x 110 x 30	1100



ZOLL / Inches



- 3/16" - 7/32" - 1/4" - 9/32" - 5/16" - 11/32" - 3/8" - 13/32" - 7/16" - 1/2"
- 1/4" - 5/16"
- 1/8" - 5/32" - 3/16" - 1/4" - 5/16" - 7/32"
- ⊕ TX10 - TX15 - TX20 - TX25 - TX27 TX30 - TX40
- 50 / 100 mm
- 1/4" ■ x 1/4" ●

1/4"	6.3	Code	Art.-No.	mm	
		1699431	4004.96	200 x 110 x 30	1100



ZOLL / Inches



- 3/16" - 7/32" - 1/4" - 9/32" - 5/16" - 11/32" - 3/8" - 13/32" - 7/16" - 1/2"
- 1/4" - 5/16"
- 1/8" - 5/32" - 3/16" - 1/4" - 5/16" - 7/32"
- ⊖ 4 - 5,5 - 6,5
- ⊕ PH 0 - 1 - 2 - 3
- 50 / 100 mm
- 1/4" ■ x 1/4" ●

1/4"	6.3	Code	Art.-No.	mm	
		1699458	4004.98	200 x 110 x 30	1100

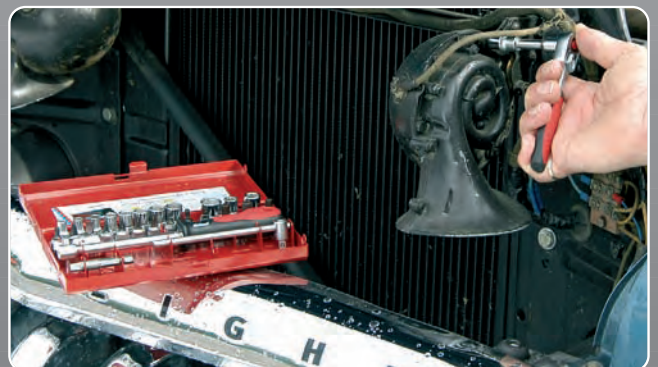

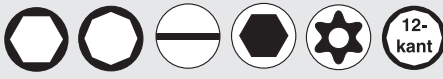

3/8" 1/2" 1/2" 1/4"

carolus

ZOLL / Inches

2



ZOLL / Inches

5°
72 Zähne/Teeth

1/4" - 5/16" - 3/8" - 7/16" - 1/2" - 9/16" - 5/8" - 11/16" - 3/4"
3/8" x 1/4"
45 / 100 mm

3/8" 10	Code	Art.-No.	mm	g
	1518682	6790.00	270 x 135 x 35	1798



ZOLL / Inches

12-kant

5/16" - 3/8" - 13/32" - 7/16" - 1/2" - 9/16" - 19/32" - 5/8" - 11/16" - 3/4" - 25/32" - 13/16" - 7/8" - 15/16" - 1-1/16" - 1-1/8" - 1-3/16" - 1-1/4"

1/2" 12.5	Code	Art.-No.	mm	g
	1893777	5011.00	480 x 160 x 50	5160

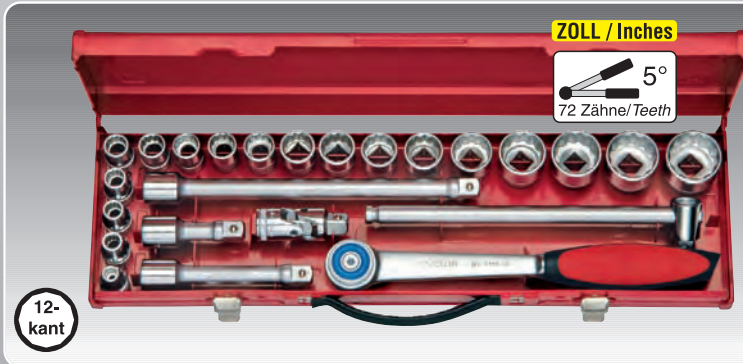

ZOLL / Inches

5°
72 Zähne/Teeth

12-kant

5/16" - 3/8" - 13/32" - 7/16" - 1/2" - 9/16" - 19/32" - 5/8" - 11/16" - 3/4" - 25/32" - 13/16" - 7/8" - 15/16" - 1-1/16" - 1-1/8" - 1-3/16" - 1-1/4"

1/2" 12.5	Code	Art.-No.	mm	g
	1893785	5011.90	480 x 160 x 50	5160



ZOLL / Inches

12-kant

5/16" - 3/8" - 13/32" - 7/16" - 1/2" - 9/16" - 19/32" - 5/8" - 11/16" - 3/4" - 25/32" - 13/16" - 7/8" - 15/16"
3/16" - 7/32" - 1/4" - 9/32" - 5/16" - 11/32" - 3/8" - 13/32" - 7/16" - 1/2"
1/4" - 5/16"
1/8" - 5/32" - 3/16" - 1/4" - 5/16" - 7/32"
TX10 - 15 - 20 - 25 - 27 - 30 - 40
5,5
50 / 100 mm

1/2" 12.5 1/4" 6.3	Code	Art.-No.	mm	g
	1893831	5811.00	480 x 160 x 50	4900

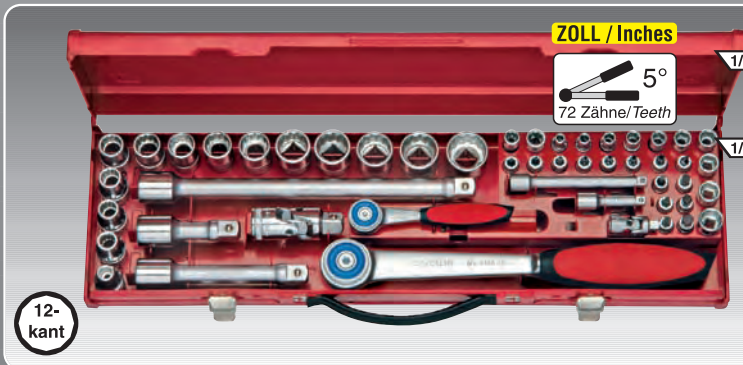

ZOLL / Inches

12-kant

5/16" - 3/8" - 13/32" - 7/16" - 1/2" - 9/16" - 19/32" - 5/8" - 11/16" - 3/4" - 25/32" - 13/16" - 7/8" - 15/16"
3/16" - 7/32" - 1/4" - 9/32" - 5/16" - 11/32" - 3/8" - 13/32" - 7/16" - 1/2"
1/4" - 5/16"
1/8" - 5/32" - 3/16" - 1/4" - 5/16" - 7/32"
TX10 - 15 - 20 - 25 - 27 - 30 - 40
5,5
50 / 100 mm

1/2" 12.5 1/4" 6.3	Code	Art.-No.	mm	g
	1893858	5811.90	480 x 160 x 50	4900



- 8 - 10 - 11 - 12 - 13 - 14 - 15 - 16 - 17 - 18 - 19 mm
- TX 7 - 8 - 9 mm
- TX 10 - 15 - 20 - 25 - 27 - 30 - 40
- 3 - 4 - 5 - 6 - 8 mm
- 6 - 6,5 - 8 mm
- PH 1 - 2 - 3
- PZ 1 - 2 - 3
- 45 / 150 mm
- 3/8" □ x 1/4" ○
- 1/4" □ x 1/4" ○

3/8" 10	Code	Art.-No.	mm	
	1696610	6863.00	270 x 135 x 35	2066



- 8 - 10 - 11 - 12 - 13 - 14 - 15 - 16 - 17 - 18 - 19 mm
- TX 7 - 8 - 9 mm
- TX 10 - 15 - 20 - 25 - 27 - 30 - 40
- 3 - 4 - 5 - 6 - 8 mm
- 6 - 6,5 - 8 mm
- PH 1 - 2 - 3
- PZ 1 - 2 - 3
- 45 / 150 mm
- 3/8" □ x 1/4" ○
- 1/4" □ x 1/4" ○

3/8" 10	Code	Art.-No.	mm	
	1696629	6863.90	270 x 135 x 35	2178



- 8 - 10 - 11 - 12 - 13 - 14 - 15 - 16 - 17 - 18 - 19 mm
- TX 7 - 8 - 9 mm
- TX 10 - 15 - 20 - 25 - 27 - 30 - 40
- 3 - 4 - 5 - 6 - 8 mm
- 6 - 6,5 - 8 mm
- PH 1 - 2 - 3
- PZ 1 - 2 - 3
- 45 / 150 mm
- 3/8" □ x 1/4" ○
- 1/4" □ x 1/4" ○

3/8" 10	Code	Art.-No.	mm	
	1518887	6862.00	270 x 135 x 35	2056



- 8 - 10 - 11 - 12 - 13 - 14 - 15 - 16 - 17 - 18 - 19 mm
- TX 7 - 8 - 9 mm
- TX 10 - 15 - 20 - 25 - 27 - 30 - 40
- 3 - 4 - 5 - 6 - 8 mm
- 6 - 6,5 - 8 mm
- PH 1 - 2 - 3
- PZ 1 - 2 - 3
- 45 / 150 mm
- 3/8" □ x 1/4" ○
- 1/4" □ x 1/4" ○

3/8" 10	Code	Art.-No.	mm	
	1518895	6862.90	270 x 135 x 35	2166

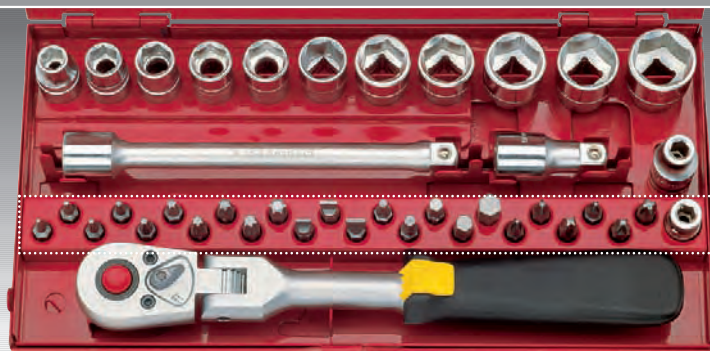

1/4"



3/8"

carolus



- 8 - 10 - 11 - 12 - 13 - 14 - 15 - 16 - 17 - 18 - 19 mm
- TX 7 - 8 - 9 mm
- ⊕ TX 10 - 15 - 20 - 25 - 27 - 30 - 40
- 3 - 4 - 5 - 6 - 8 mm
- 6 - 6,5 - 8 mm
- ⊕ PH 1 - 2 - 3
- ⊕ PZ 1 - 2 - 3
- 45 / 150 mm
- 3/8" □ x 1/4" ○ 1/4" □ x 1/4" ○

3/8"	10	Code	Art.-No.	mm	g
		1518879	6861.00	270 x 135 x 35	1978



5°
72 Zähne/Teeth

- 8 - 10 - 11 - 12 - 13 - 14 - 15 - 16 - 17 - 18 - 19 mm
- TX 7 - 8 - 9 mm
- ⊕ TX 10 - 15 - 20 - 25 - 27 - 30 - 40
- 3 - 4 - 5 - 6 - 8 mm
- 6 - 6,5 - 8 mm
- ⊕ PH 1 - 2 - 3
- ⊕ PZ 1 - 2 - 3
- 45 / 150 mm
- 3/8" □ x 1/4" ○ 1/4" □ x 1/4" ○

3/8"	10	Code	Art.-No.	mm	g
		1518860	6860.00	270 x 135 x 35	1922



2



2



8 - 10 - 11 - 12 - 13 - 14 - 15 - 16 - 17 - 18 - 19 mm
45 / 150 mm
3/8" □ x 1/4" ○

3/8"	10	Code	Art.-No.	mm	g
		1696599	6853.00	270 x 135 x 35	1712



5°
72 Zähne/Teeth

8 - 10 - 11 - 12 - 13 - 14 - 15 - 16 - 17 - 18 - 19 mm
45 / 150 mm
3/8" □ x 1/4" ○

3/8"	10	Code	Art.-No.	mm	g
		1696602	6853.90	270 x 135 x 35	1800



8 - 10 - 11 - 12 - 13 - 14 - 15 - 16 - 17 - 18 - 19 mm
45 / 150 mm
3/8" □ x 1/4" ○

3/8"	10	Code	Art.-No.	mm	g
		1518844	6852.00	270 x 135 x 35	1752



5°
72 Zähne/Teeth

8 - 10 - 11 - 12 - 13 - 14 - 15 - 16 - 17 - 18 - 19 mm
45 / 150 mm
3/8" □ x 1/4" ○

3/8"	10	Code	Art.-No.	mm	g
		1518852	6852.90	270 x 135 x 35	1798

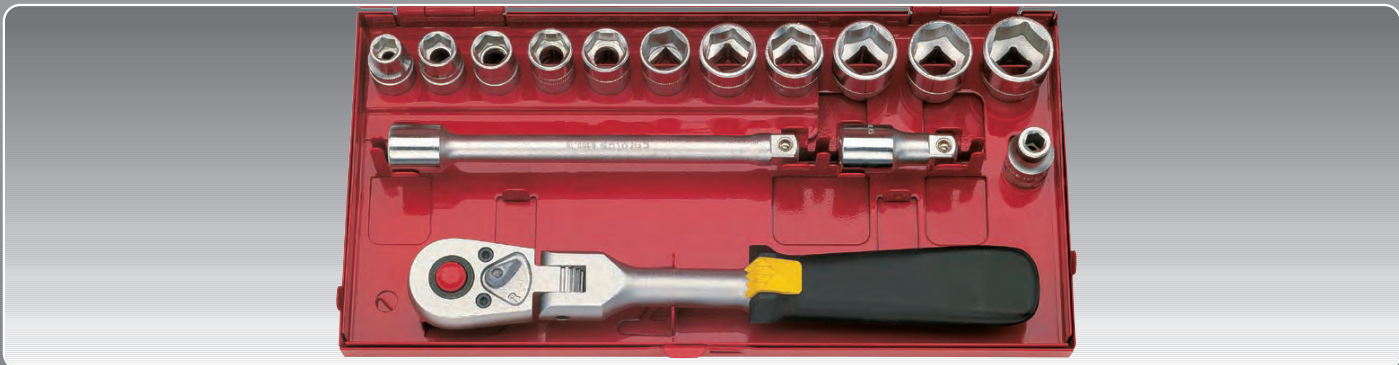



3/8"

carolus



8 - 10 - 11 - 12 - 13 - 14 - 15 - 16 - 17 - 18 - 19 mm
 45 / 150 mm
 3/8" □ x 1/4" ○

3/8"	10	Code	Art.-No.	mm	g
		1518836	6851.00	270 x 135 x 35	1696



5°
 72 Zähne/Teeth

8 - 10 - 11 - 12 - 13 - 14 - 15 - 16 - 17 - 18 - 19 mm
 45 / 150 mm
 3/8" □ x 1/4" ○

3/8"	10	Code	Art.-No.	mm	g
		1518801	6850.00	270 x 135 x 35	1660

2





2

3/8" 8 - 10 - 11 - 12 - 13 - 14 - 15 - 16 - 17 - 18 - 19 mm
 45 / 150 mm
 3/8" □ x 1/4" ○

1/4" 8 - 9 - 10 - 11 - 12 - 13 mm

3/8" 10	Code	Art.-No.	mm	
1/4" 6.3	1518771	6825.25	270 x 135 x 35	2150

3/8" 8 - 10 - 11 - 12 - 13 - 14 - 15 - 16 - 17 - 18 - 19 mm
 45 / 150 mm
 3/8" □ x 1/4" ○

1/4" 8 - 9 - 10 - 11 - 12 - 13 mm

3/8" 10	Code	Art.-No.	mm	
1/4" 6.3	1699474	6898.70	270 x 135 x 35	2134

5°
72 Zähne/Teeth

5°
72 Zähne/Teeth

3/8" 8 - 10 - 11 - 12 - 13 - 14 - 15 - 16 - 17 - 18 - 19 mm
 45 / 150 mm
 3/8" □ x 1/4" ○

1/4" 8 - 9 - 10 - 11 - 12 - 13 mm

3/8" 10	Code	Art.-No.	mm	
1/4" 6.3	1696580	6815.25	270 x 135 x 35	2140

3/8" 8 - 10 - 11 - 12 - 13 - 14 - 15 - 16 - 17 - 18 - 19 mm
 45 / 150 mm
 3/8" □ x 1/4" ○

1/4" 8 - 9 - 10 - 11 - 12 - 13 mm

3/8" 10	Code	Art.-No.	mm	
1/4" 6.3	1518925	6899.70	270 x 135 x 35	2124

5°
72 Zähne/Teeth

5°
72 Zähne/Teeth

3/8" 8 - 10 - 11 - 12 - 13 - 14 - 15 - 16 - 17 - 18 - 19 mm
 45 / 150 mm
 3/8" □ x 1/4" ○

1/4" 8 - 9 - 10 - 11 - 12 - 13 mm

3/8" 10	Code	Art.-No.	mm	
1/4" 6.3	1518917	6899.35	270 x 135 x 35	2130

5°
72 Zähne/Teeth

5°
72 Zähne/Teeth



1/2"

carolus

2



- 10 - 11 - 12 - 13 - 14 - 15 - 16 - 17 - 18 - 19 - 20 - 21 - 22 - 24 - 27 - 28 - 30 - 32 mm
- 75 mm
- 125 mm
- 250 mm
- 1/2" □ x 5/16" ○

1/2"	12.5	Code	Art.-No.	mm	g
		1516213	5025.00	480 x 160 x 50	5220



5°
72 Zähne/Teeth

- 10 - 11 - 12 - 13 - 14 - 15 - 16 - 17 - 18 - 19 - 20 - 21 - 22 - 24 - 27 - 28 - 30 - 32 mm
- 75 mm
- 125 mm
- 250 mm
- 1/2" □ x 5/16" ○

1/2"	12.5	Code	Art.-No.	mm	g
		1696009	5098.00	480 x 160 x 50	5240



- 10 - 11 - 12 - 13 - 14 - 15 - 16 - 17 - 18 - 19 - 20 - 21 - 22 - 24 - 27 - 28 - 30 - 32 mm
- 75 mm
- 125 mm
- 250 mm
- 1/2" □ x 5/16" ○

1/2"	12.5	Code	Art.-No.	mm	g
		1695991	5015.00	480 x 160 x 50	5210



5°
72 Zähne/Teeth

- 10 - 11 - 12 - 13 - 14 - 15 - 16 - 17 - 18 - 19 - 20 - 21 - 22 - 24 - 27 - 28 - 30 - 32 mm
- 75 mm
- 125 mm
- 250 mm
- 1/2" □ x 5/16" ○

1/2"	12.5	Code	Art.-No.	mm	g
		1516248	5099.00	480 x 160 x 50	5230

2



- 10 - 11 - 12 - 13 - 14 - 15 - 16 - 17 - 18 - 19 - 20 - 21 - 22 - 24 - 27 - 28 - 30 - 32 mm
- 75 mm
- 125 mm
- 250 mm
- 1/2" □ x 5/16" ○

1/2"	12.5	Code	Art.-No.	mm	
		1516191	5000.00	480 x 160 x 50	5160



12-kant

- 10 - 11 - 12 - 13 - 14 - 15 - 16 - 17 - 18 - 19 - 21 - 22 - 24 - 27 - 28 - 30 - 32 mm
- 75 mm
- 125 mm
- 250 mm
- 1/2" □ x 5/16" ○

1/2"	12.5	Code	Art.-No.	mm	
		1893793	5012.00	480 x 160 x 50	5160



5°
72 Zähne/Teeth

- 10 - 11 - 12 - 13 - 14 - 15 - 16 - 17 - 18 - 19 - 20 - 21 - 22 - 24 - 27 - 28 - 30 - 32 mm
- 75 mm
- 125 mm
- 250 mm
- 1/2" □ x 5/16" ○

1/2"	12.5	Code	Art.-No.	mm	
		1516221	5090.00	480 x 160 x 50	5106



12-kant

5°
72 Zähne/Teeth

- 10 - 11 - 12 - 13 - 14 - 15 - 16 - 17 - 18 - 19 - 21 - 22 - 24 - 27 - 28 - 30 - 32 mm
- 75 mm
- 125 mm
- 250 mm
- 1/2" □ x 5/16" ○

1/2"	12.5	Code	Art.-No.	mm	
		1893823	5012.90	480 x 160 x 50	5106



12-kant

1/2"

carolus



- 10 - 11 - 12 - 13 - 14 - 15 - 17 - 18 - 19 - 24 mm
- 75 mm
- 250 mm
- 1/2" □ x 5 / 16" ○

1/2"	12,5	Code	Art.-No.	mm	g
		1696076	5600.00	480 x 160 x 50	3500

2



5°
72 Zähne/Teeth

- 10 - 11 - 12 - 13 - 14 - 15 - 17 - 18 - 19 - 24 mm
- 75 mm
- 250 mm
- 1/2" □ x 5 / 16" ○

1/2"	12,5	Code	Art.-No.	mm	g
		1696084	5690.00	480 x 160 x 50	3500



- 10 - 11 - 13 - 14 - 15 - 17 - 19 - 22 - 24 mm
- 125 mm

1/2"	12,5	Code	Art.-No.	mm	g
		1928732	5100.00	280 x 80 x 50	1764



12-kant



- 10 - 11 - 13 - 14 - 15 - 17 - 19 - 22 - 24 mm
- 125 mm

1/2"	12,5	Code	Art.-No.	mm	g
		1928740	5112.00	280 x 80 x 50	1764

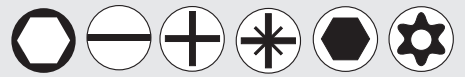

2



readyflex

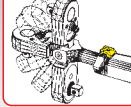

- 1/2" 10 - 11 - 12 - 13 - 14 - 15 - 16 - 17 - 18 - 19 - 21 - 22 - 24 mm
 75 mm
 125 mm
 250 mm
 1/2" □ x 5/16"
- 1/4" 4 - 4,5 - 5 - 5,5 - 6 - 7 - 8 - 9 - 10 - 11 - 12 - 13 mm
 TX10 - TX15 - TX20 - TX25 - TX27 - TX30 - TX40
 4 - 5 - 6 - 8 mm
 5,5 mm
 PH 2 PZ 2
 50 mm
 100 mm

1/2"	12,5	Code	Art.-No.	mm	kg
1/4"	6,3	1516922	5825.25	480 x 160 x 50	5000



readyflex



5°
72 Zähne/Teeth

- 1/2" 10 - 11 - 12 - 13 - 14 - 15 - 16 - 17 - 18 - 19 - 21 - 22 - 24 mm
 75 mm
 125 mm
 250 mm
 1/2" □ x 5/16"
- 1/4" 4 - 4,5 - 5 - 5,5 - 6 - 7 - 8 - 9 - 10 - 11 - 12 - 13 mm
 TX10 - TX15 - TX20 - TX25 - TX27 - TX30 - TX40
 4 - 5 - 6 - 8 mm
 5,5 mm
 PH 2 PZ 2
 50 mm
 100 mm

1/2"	12,5	Code	Art.-No.	mm	kg
1/4"	6,3	1699466	5898.70	480 x 160 x 50	5024



readyflex

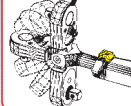

- 1/2" 10 - 11 - 12 - 13 - 14 - 15 - 16 - 17 - 18 - 19 - 21 - 22 - 24 mm
 75 mm
 125 mm
 250 mm
 1/2" □ x 5/16"
- 1/4" 4 - 4,5 - 5 - 5,5 - 6 - 7 - 8 - 9 - 10 - 11 - 12 - 13 mm
 TX10 - TX15 - TX20 - TX25 - TX27 - TX30 - TX40
 4 - 5 - 6 - 8 mm
 5,5 mm
 PH 2 PZ 2
 50 mm
 100 mm

1/2"	12,5	Code	Art.-No.	mm	kg
1/4"	6,3	1696092	5815.25	480 x 160 x 50	4990





- 1/2" 10 - 11 - 12 - 13 - 14 - 15 - 16 - 17 - 18 - 19 - 21 - 22 - 24 mm
 75 mm
 125 mm
 250 mm
 1/2" □ x 5 /16" ○

- 1/4" 4 - 4,5 - 5 - 5,5 - 6 - 7 - 8 - 9 - 10 - 11 - 12 - 13 mm
 TX10 - TX15 - TX20 - TX25 - TX27 - TX30 - TX40
 4 - 5 - 6 - 8 mm
 5,5 mm
 PH 2 PZ 2
 50 mm
 100 mm

1/2"	12,5	Code	Art.-No.	mm	kg
1/4"	6,3	1517023	5899.70	480 x 160 x 50	5014



- 1/2" 10 - 11 - 12 - 13 - 14 - 15 - 16 - 17 - 18 - 19 - 21 - 22 - 24 mm
 75 mm
 125 mm
 250 mm
 1/2" □ x 5 /16" ○

- 1/4" 4 - 4,5 - 5 - 5,5 - 6 - 7 - 8 - 9 - 10 - 11 - 12 - 13 mm
 TX10 - TX15 - TX20 - TX25 - TX27 - TX30 - TX40
 4 - 5 - 6 - 8 mm
 5,5 mm
 PH 2 PZ 2
 50 mm
 100 mm

1/2"	12,5	Code	Art.-No.	mm	kg
1/4"	6,3	1517007	5899.35	480 x 160 x 50	5028



- 1/2" 10 - 11 - 12 - 13 - 14 - 15 - 16 - 17 - 18 - 19 - 21 - 22 - 24 mm
 75 mm
 125 mm
 250 mm
 1/2" □ x 5 /16" ○

- 1/4" 4 - 4,5 - 5 - 5,5 - 6 - 7 - 8 - 9 - 10 - 11 - 12 - 13 mm
 TX10 - TX15 - TX20 - TX25 - TX27 - TX30 - TX40
 4 - 5 - 6 - 8 mm
 5,5 mm
 PH 2 PZ 2
 50 mm
 100 mm

1/2"	12,5	Code	Art.-No.	mm	kg
1/4"	6,3	1516906	5800.00	480 x 160 x 50	4990



2



5°
72 Zähne/Teeth

- 1/2"**
- 10 - 11 - 12 - 13 - 14 - 15 - 16 - 17 - 18 - 19 - 21 - 22 - 24 mm
 - 75 mm
 - 125 mm
 - 250 mm
 - 1/2" □ x 5/16" ○
- 1/4"**
- 4 - 4,5 - 5 - 5,5 - 6 - 7 - 8 - 9 - 10 - 11 - 12 - 13 mm
 - TX10 - TX15 - TX20 - TX25 - TX27 - TX30 - TX40
 - 4 - 5 - 6 - 8 mm
 - 5,5 mm
 - PH 2 ⊕ PZ 2
 - 50 mm
 - 100 mm

1/2"	12,5	Code	Art.-No.	mm	kg
1/4"	6,3	1516981	5890.90	480 x 160 x 50	4850



5°
72 Zähne/Teeth

- 1/2"**
- 10 - 11 - 12 - 13 - 14 - 15 - 16 - 17 - 18 - 19 - 21 - 22 - 24 mm
 - 75 mm
 - 125 mm
 - 250 mm
 - 1/2" □ x 5/16" ○
- 1/4"**
- 8 - 10 - 12 - 13 mm
 - TX10 - TX15 - TX20 - TX25 - TX30 - TX40
 - 8 - 9 - 10 - 11 - 12 - 13
 - 8 mm x 1/4"

1/2"	12,5	Code	Art.-No.	mm	kg
1/4"	6,3	1516973	5890.30	480 x 160 x 50	4760





○ 10 - 12 - 13 - 14 - 15 - 17 - 19 - 21 - 22 - 23 - 24 -
27 - 30 - 32 mm
↔ 75 mm

1/2"	12,5	Code	Art.-No.	mm	g
		1825054	5560.00	435 x 90 x 50	3740

2



○ 17 - 19 - 21 mm
↔ 85 mm

1/2"	12,5	Code	Art.-No.	mm	g
		1854178	5575.00	150 x 130 x 55	845



○ 17 - 19 - 21 mm
↔ 150 mm

1/2"	12,5	Code	Art.-No.	mm	g
		1854194	5576.00	255 x 145 x 45	1500



1/2"



○ E10 - E11 - E12 - E14 - E16 - E18 - E20 - E22 - E24
⊕ TX30 - TX40 - TX45 - TX50 - TX55 - TX60 - TX70

1/2"	12,5	Code	Art.-No.	mm	g
		1852035	5530.00	200 x 100 x 45	1700

2



○ 10 - 11 - 12 - 13 - 14 - 15 - 16 - 17 - 19 - 21 - 22 - 24 mm
 ← 85 mm →

1/2"	12,5	Code	Art.-No.	mm	g
		1852078	5565.00	335 x 100 x 40	3400



○ 10 - 11 - 12 - 13 - 14 - 15 - 16 - 17 - 19 - 21 - 22 - 24 mm

1/2"	12,5	Code	Art.-No.	mm	g
		1852051	5540.00	200 x 85 x 50	1600



⊕ E6 - E7 - E8 - E10 - E11 - E12 - E14 - E16 - E18 - E20 - E22 - E24 mm

1/2"	12,5	Code	Art.-No.	mm	g
		1852043	5535.00	200 x 85 x 50	1540



○ 26 - 27 - 29 - 30 - 32 - 33 - 36 - 38 mm

3/4"	20	Code	Art.-No.	mm	g
		1852310	8560.00	225 x 120 x 60	4000

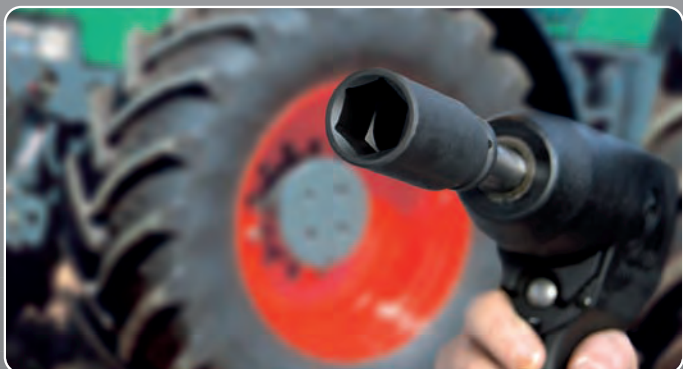



3/4"

carolus

2



22 - 24 - 27 - 30 - 32 - 36 - 38 - 41 - 46 - 50 mm
 200 mm
 400 mm

3/4"	20	Code	Art.-No.	mm	g
		1683268	8100.00	525 x 203 x 73	10300





2

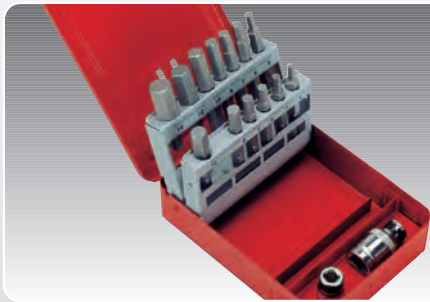

50 mm
● 4 - 5 - 6 - 7 - 8 - 10 - 12 - 14 mm

100 mm
● 5 - 6 - 7 - 8 - 10 mm

3/8" □ x 5/16" ○
1/2" □ x 5/16" ○

Code	Art.-No.
1518364	6460.10

mm	g
160 x 112 x 37	960

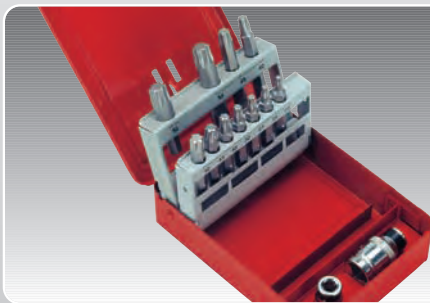

50 mm
● TX20 - TX25 - TX27 - TX30 - TX40 - TX45 - TX50 - TX55

100 mm
● TX40 - TX45 - TX55

3/8" □ x 5/16" ○
1/2" □ x 5/16" ○

Code	Art.-No.
1518372	6460.20

mm	g
160 x 112 x 37	842

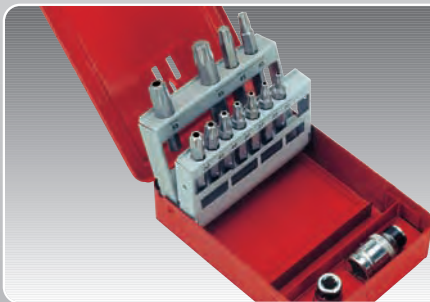

50 mm
● TX20 - TX25 - TX27 - TX30 - TX40 - TX45 - TX50 - TX55

100 mm
● TX40 - TX45 - TX55

3/8" □ x 5/16" ○
1/2" □ x 5/16" ○

Code	Art.-No.
1518380	6460.21

mm	g
160 x 112 x 37	836

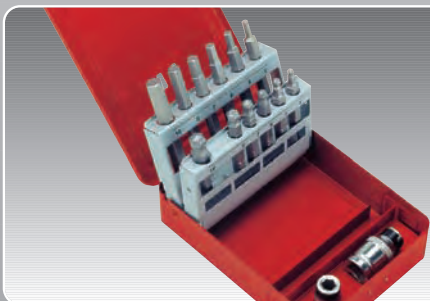

50 mm
● 4 - 5 - 6 - 7 - 8 - 10 mm

100 mm
● 4 - 5 - 6 - 7 - 8 - 10 mm

3/8" □ x 5/16" ○
1/2" □ x 5/16" ○

Code	Art.-No.
1518399	6460.30

mm	g
160 x 112 x 37	896

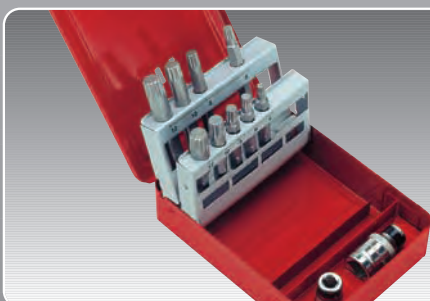

50 mm
● 5 - 6 - 8 - 10 - 12

100 mm
● 6 - 8 - 10 - 12

3/8" □ x 5/16" ○
1/2" □ x 5/16" ○

Code	Art.-No.
1518402	6460.40

mm	g
160 x 112 x 37	856

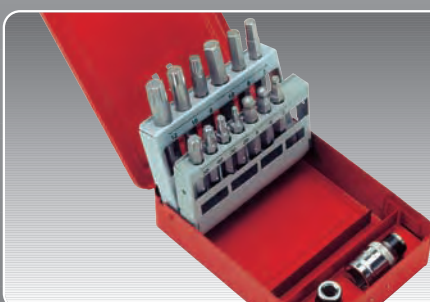

50 mm
● TX20 - TX30 - TX40 - TX50
● 5 - 6 - 8

100 mm
● 8 - 10 - 12
● 7 - 8 - 10

3/8" □ x 5/16" ○
1/2" □ x 5/16" ○

Code	Art.-No.
1518410	6460.50

mm	g
160 x 112 x 37	954



5/16"

carolus

2



50 mm
 TX20 - TX25 - TX27 - TX30 - TX40 - TX45 - TX50 - TX55
 100 mm
 TX40 - TX45 - TX55
 E4 - E5 - E6 - E7 - E8 - E10 - E12 - E14 - E16
 3/8" x 5/16"
 5/16" x 5/16"

Code	Art.-No.	mm	
1518305	6400.25	265 x 130 x 44	1940



50 mm
 TX20 - TX25 - TX27 - TX30 - TX40 - TX45 - TX50 - TX55
 100 mm
 TX40 - TX45 - TX55
 E4 - E5 - E6 - E7 - E8 - E10 - E12 - E14 - E16
 3/8" x 5/16"
 5/16" x 5/16"

Code	Art.-No.	mm	
1518321	6400.26	265 x 130 x 44	1934



50 mm
 TX20 - TX25 - TX27 - TX30 - TX40 - TX45 - TX50 - TX55
 100 mm
 TX40 - TX45 - TX55
 E4 - E5 - E6 - E7 - E8 - E10 - E12 - E14 - E16
 3/8" x 5/16"
 5/16" x 5/16"

Code	Art.-No.	mm	
1518445	6490.25	265 x 130 x 44	1800



50 mm
 TX20 - TX25 - TX27 - TX30 - TX40 - TX45 - TX50 - TX55
 100 mm
 TX40 - TX45 - TX55
 E4 - E5 - E6 - E7 - E8 - E10 - E12 - E14 - E16
 3/8" x 5/16"
 5/16" x 5/16"

Code	Art.-No.	mm	
1518453	6490.26	265 x 130 x 44	1799



Schlüsselweiten und Gewinde-Durchmesser

2

mm	M	"AF	Whitw.	mm	mm	mm
Ø	Ø	Ø	Ø	Ø	min.	max.
2,5	1	0		2,5	2,52	2,58
3	1,4 u. 1,2	0,3969		3	3,02	3,08
3,2	1,6	0,7938		3,2	3,22	3,28
4	2	5/32	8 BA	3,5	3,52	3,58
4,5	2,3		7 BA	4	4,02	4,12
5	2,5	3/16	6 BA	4,5	4,52	4,62
5,5	3	7/32	5 BA	5	5,02	5,12
6	3,5	1/4	4 BA 1/16 W	5,5	5,52	5,62
				6	6,03	6,15
7	4	9/32	3 BA	7	7,03	7,15
7+ 8	5	5/16	3/32 W 2 BA	8	8,03	8,15
9	5 Alt	11/32	1/8 W	9	9,03	9,15
		3/8	1 BA			
8+10	6	13/32	0 BA	10	10,04	10,19
11	7	7/16	3/16 W	11	11,04	11,19
12				12	12,04	12,24
10+13	8	1/2	1/4 W	13	13,04	13,24
14*	8 Alt	9/16		14	14,05	14,27
15	10 KFZ	19/32	5/16 W	15	15,05	15,27
16		5/8		16	16,05	16,27
13+15+17	10	11/16		17	17,05	17,30
18			3/8 W	18	18,05	18,30
15+18+19	12	3/4		19	19,06	19,36
20*		25/32		21	21,06	21,36
18+21		13/16	7/16 W	22	22,06	22,36
22+24	14	7/8		23	23,06	23,36
23*			1/2 W	24	24,06	24,36
21+24*	16	15/16		26	26,08	26,48
25*+27*		1.		27	27,08	27,48
26*			9/16 W	29	29,08	29,48
27*	18	1.1/16	5/8 W	30	30,08	30,48
27+28*+30*				32	32,08	32,48
27+30+34	20	1.3/16	11/16 W	34	34,10	34,60
32+36+41	22	1.1/4		35	35,10	35,62
		1.5/16	3/4 W	36	36,10	36,60
34	22	1.3/8	13/16 W	38	38,10	38,60
36+41	24	1.7/16		41	41,10	41,60
38*		1.1/2	7/8 W	42	42,10	42,60
41+46	27	1.5/8		46	46,10	46,60
		1.11/16	1. W			
46+50	30	1.3/4		50	50,10	50,60
		1.13/16	1.1/8 W	54	54,12	54,72
		1.7/8				
50+55	33	2.		55	55,12	55,72
		2.1/16	1.1/4 W	58	58,12	58,72
55+60	36	2.3/16		60	60,12	60,72
60+65	39	2.1/4	1.3/8 W	63	63,12	63,72
		2.3/8		65	65,12	65,72
		2.7/16	1.1/2 W	67	67,12	67,72
65	42	2.9/16	1.5/8 W	70	70,12	70,72
		2.5/8		71	71,15	71,85
70	45	2.3/4	1.3/4 W	75	75,15	75,85
75	48	2.13/16		77	77,15	77,85
		2.15/16		80	80,15	80,85
		3	(1.7/8 W)	82	82,15	82,85
80	52	3.1/8		85	85,15	85,85
85	56	3.3/8	2. W	88	88,15	88,85
90	60	3.1/2		90	90,15	90,85
95	64	3.3/4		94	94,15	94,85
		3.7/8		95	95,15	95,85
100	68			100	100,15	100,85
105	72	4.1/8		105	105,20	106,00
110	76	4.1/4		110	110,20	111,00
115	80	4.1/2		115	115,20	116,00
120	85	4.5/8		116	116,20	117,00
125		4.7/8		120	120,20	121,00
		5.				
130	90	5.1/4		130*	130,20	131,00
135	95	5.3/8		135*	136,00	136,40
140		5.5/8				
145	100	5.3/4		145*	145,20	146,00
150	105	6.		150*	150,25	151,25
155	110	6.1/8		155*	155,25	156,25
160				165*	165,25	166,25
165	115			170*	170,25	171,25
170	120					
175*	Ø			175*	175,25	176,25
180	125			180*	180,25	181,25
185	130			185*	185,25	186,25
200	140			200*	200,25	201,25
210	150			210*	210,25	211,25

Umrechnungstabellen Zoll in Dezimal-Zoll und mm

in.	dec. in.	mm	in.	dec. in.	mm
0	0	0	1/2	0.5	12,7000
1/64	0.015625	0,3969	33/64	0.515625	13,0969
1/32	0.03125	0,7938	17/32	0.53125	13,4938
3/64	0.046875	1,1906	35/64	0.546875	13,8906
1/16	0.0625	1,5875	9/16	0.5625	14,2875
5/64	0.078125	1,9844	37/64	0.578125	14,6844
3/32	0.09375	2,3812	19/32	0.59375	15,0812
7/64	0.109375	2,7781	39/64	0.609375	15,4781
1/8	0.125	3,1750	5/8	0.625	15,8750
9/64	0.140625	3,5719	41/64	0.640625	16,2719
5/32	0.15625	3,9688	21/32	0.65625	16,6688
11/64	0.171875	4,3656	43/64	0.671875	17,0656
3/16	0.1875	4,7625	11/16	0.6875	17,4625
13/64	0.203125	5,1594	45/64	0.703125	17,8594
7/32	0.21875	5,5562	23/32	0.71875	18,2562
15/64	0.234375	5,9531	47/64	0.734375	18,6531
1/4	0.25	6,3500	3/4	0.75	19,0500
17/64	0.265625	6,7469	49/64	0.765625	19,4469
9/32	0.28125	7,1438	25/32	0.78125	19,8438
19/64	0.296875	7,5406	51/64	0.796875	20,2406
5/16	0.3125	7,9375	13/16	0.8125	20,6375
21/64	0.328125	8,3344	53/64	0.828125	21,0344
11/32	0.34375	8,7312	27/32	0.84375	21,4312
23/64	0.359375	9,1281	55/64	0.859375	21,8281
3/8	0.375	9,5250	7/8	0.875	22,2250
25/64	0.390625	9,9219	57/64	0.890625	22,6219
13/32	0.40625	10,3188	29/32	0.90625	23,0188
27/64	0.421875	10,7156	59/64	0.921875	23,4156
7/16	0.4375	11,1125	15/16	0.9375	23,8125
29/64	0.453125	11,5094	61/64	0.953125	24,2094
15/32	0.46875	11,9062	31/32	0.96875	24,6062
31/64	0.484375	12,3031	63/64	0.984375	25,0031
			1	1	25,4000



3



3

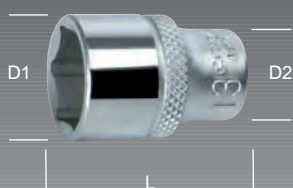

1/4" 6,3

Code	Art.-No.	mm	L mm	D1 mm	D2 mm	⌀
1515187	4177.04	4	25	12	6,8	12
1515446	4177.45	4,5	25	12	7,2	13
1515195	4177.05	5	25	12	7,8	13
1515454	4177.55	5,5	25	12	8,4	13
1515209	4177.06	6	25	12	9,3	14
1515217	4177.07	7	25	12	11	14
1515225	4177.08	8	25	11	12	14
1515233	4177.09	9	25	12	13	15
1515241	4177.10	10	25	12	14,6	17
1515276	4177.11	11	25	13	16	22
1515284	4177.12	12	25	13	17	23
1515292	4177.13	13	25	13	18	25
1515306	4177.14	14	25	13	19	23



1/4" 6,3

Code	Art.-No.	mm	L mm	D1 mm	D2 mm	⌀
1515039	4176.04	4	50	12	6,8	28
1515160	4176.45	4,5	50	12	7,2	26
1515055	4176.05	5	50	12	7,8	30
1515179	4176.55	5,5	50	12	8,4	30
1515063	4176.06	6	50	12	9,3	29
1515071	4176.07	7	50	12	11	25
1515098	4176.08	8	50	12	12	24
1515101	4176.09	9	50	12	13	32
1515128	4176.10	10	50	12	14,6	39
1515136	4176.11	11	50	13	16	50
1515144	4176.12	12	50	13	17	55
1515152	4176.13	13	50	13	18	50



1/4" 6,3 ZOLL / Inches

Code	Art.-No.	ZOLL / Inches	L mm	D1 mm	D2 mm	⌀
1514830	4175.01	3/16"	25	12	7,5	12
1514849	4175.02	7/32"	25	12	8,4	12
1514857	4175.03	1/4"	25	12	9,3	12
1514865	4175.04	9/32"	25	12	11	14
1514873	4175.05	5/16"	25	11	12	14
1514881	4175.06	11/32"	25	12	13	15
1514903	4175.07	3/8"	25	12	14	15
1514911	4175.08	13/32"	25	12	14,5	16
1514938	4175.09	7/16"	25	13	16	20
1514946	4175.10	1/2"	25	13	18	25

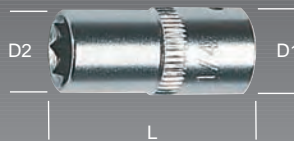

1/4" 6,3 ZOLL / Inches

Code	Art.-No.	ZOLL / Inches	L mm	D1 mm	D2 mm	⌀
1514954	4175.11	1/4"	25	12	11	13
1514962	4175.12	5/16"	25	12	14,5	18

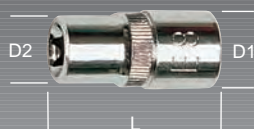

Code	Art.-No.		L mm	D1 mm	D2 mm	⌀ _{6.3}
1514784	4174.05	E 5	25	12	7	13
1514792	4174.06	E 6	25	12	8	14
1514806	4174.07	E 7	25	12	9	14
1514814	4174.08	E 8	25	12	10	15
1514822	4174.10	E10	25	12	11	15

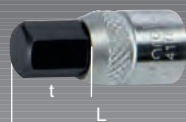

Code	Art.-No.	ZOLL / Inches	L mm	t mm	⌀ _{6.3}
1514970	4175.13	1/8"	26	9,5	13
1514989	4175.14	5/32"	26	9,5	13
1514997	4175.15	3/16"	26	9,5	13
1515004	4175.16	1/4"	26	9,5	15
1515012	4175.17	5/16"	26	9,5	17
1515020	4175.18	7/32"	26	9,5	14

3



Code	Art.-No.		L mm	t mm	⌀ _{6.3}
1514709	4173.10	TX10	26	9,5	11
1514717	4173.15	TX15	26	9,5	12
1514725	4173.20	TX20	26	9,5	12
1514733	4173.25	TX25	26	9,5	13
1514741	4173.27	TX27	26	9,5	13
1514768	4173.30	TX30	26	9,5	13
1514776	4173.40	TX40	26	9,5	13



Code	Art.-No.	mm	L mm	t mm	⌀ _{6.3}
1515632	4179.04	4	26	9,5	13
1515667	4179.55	5,5	26	9,5	14
1515713	4179.65	6,5	26	9,5	15



Code	Art.-No.	mm	L mm	t mm	⌀ _{6.3}
1515470	4178.03	3	26	9,5	13
1515489	4178.04	4	26	9,5	13
1515497	4178.05	5	26	9,5	14
1515500	4178.06	6	26	9,5	15
1515519	4178.08	8	26	9,5	16
1515535	4178.10	10	26	9,5	19



Code	Art.-No.		L mm	t mm	⌀ _{6.3}
1515756	4179.10	⊕PH 0	26	9,5	13
1515764	4179.20	⊕PH 1	26	9,5	13
1515772	4179.30	⊕PH 2	26	9,5	13
1515780	4179.40	⊕PH 3	26	9,5	13
1514660	4172.00	⊕PZ 0	26	9,5	13
1514679	4172.10	⊕PZ 1	26	9,5	13
1514687	4172.20	⊕PZ 2	26	9,5	13
1514695	4172.30	⊕PZ 3	26	9,5	13



1/4" 6.3 6.3

Code	Art.-No.	mm				⚖
1515616	4179.50	50				29
1515608	4179.00	100				50
1515624	4179.15	150				70



1/4" 6.3

Code	Art.-No.		L mm			⚖
1512544	3100.06	TX 6	25			5
1513036	3100.07	TX 7	25			5
1513079	3100.08	TX 8	25			5
1513087	3100.09	TX 9	25			5
1513095	3100.10	TX10	25			5
1513109	3100.15	TX15	25			5
1513117	3100.20	TX20	25			5
1513125	3100.25	TX25	25			5
1513141	3100.27	TX27	25			5
1513184	3100.30	TX30	25			5
1513192	3100.40	TX40	25			5



1/4" 6.3

Code	Art.-No.		L mm			⚖
1513281	3150.10	TX10	25			5
1513303	3150.15	TX15	25			5
1513311	3150.20	TX20	25			5
1513346	3150.25	TX25	25			5
1513354	3150.27	TX27	25			5
1513362	3150.30	TX30	25			5
1513370	3150.40	TX40	25			5



1/4" 6.3

Code	Art.-No.	mm	L mm			⚖
1851977	3200.30	0,6x3,0	25			5
1513389	3200.45	0,6x4,5	25			5
1513397	3200.55	0,8x5,5	25			5
1513400	3200.60	1,0x6,0	25			5
1513419	3200.65	1,2x6,5	25			5
1513427	3200.80	1,6x8,0	25			5



1/4" 6.3

Code	Art.-No.	mm	L mm			⚖
1852027	3300.02	2	25			5
1513435	3300.03	3	25			5
1513451	3300.04	4	25			5
1513478	3300.05	5	25			5
1513486	3300.06	6	25			5
1513494	3300.08	8	25			5



1/4" 6.3

Code	Art.-No.		L mm			⚖
1513508	3400.01	1	25			5
1513516	3400.02	2	25			5
1513524	3400.03	3	25			5



1/4" 6.3

Code	Art.-No.		L mm		⚖
1513532	3500.01	1	25		5
1513540	3500.02	2	25		5
1513559	3500.03	3	25		5



1/4" 6.3

Code	Art.-No.		L mm		⚖
1513214	3130.01	1	25		5
1513257	3130.02	2	25		5
1513265	3130.03	3	25		5
1513273	3130.04	4	25		5



1/4" 6.3 8 1/4" x 8 mm

Code	Art.-No.				⚖
1516043	4386.08				28



1/4" 6.3 8 1/4" x 8 mm

Code	Art.-No.				⚖
1519220	7060.00				6

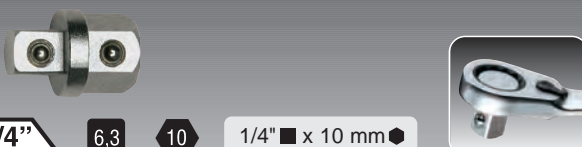

1/4" 6.3 10 1/4" x 10 mm

Code	Art.-No.				⚖
1597132	4115.10				10



55 mm

1/4" 6.3 6.3 1/4" x 1/4"

Code	Art.-No.				⚖
1519212	7055.00				25

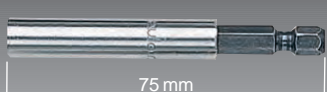

75 mm

1/4" 6.3 6.3 1/4" x 1/4"

Code	Art.-No.				⚖
1519247	7075.00				37



1/4" 6.3 6.3 1/4" x 1/4"

Code	Art.-No.				⚖
1519239	7070.00				31



1/4" 6,3 6,3 1/4" x 1/4"

Code	Art.-No.								
1519255	7080.00								10



1/4" 6,3 6,3 1/4" x 1/4"

Code	Art.-No.								
1519263	7080.50								14



1/4" 6,3 6,3 1/4" x 1/4"

Code	Art.-No.								
1515551	4178.60								21



87 mm

1/4" 6,3 6,3 1/4" x 1/4"



Code	Art.-No.								
1513826	4002.40								36



1/4" 6,3 1/4" Ω



Code	Art.-No.								
1515543	4178.50								18



1/4" 6,3 6,3

Code	Art.-No.								
1515802	4179.80								24



1/4" 6,3

Code	Art.-No.								
1514644	4060.13								30



1/4" 6,3

Code	Art.-No.								
1515799	4179.70								43



1/4" 6,3 6,3

Code	Art.-No.								
1515810	4179.94								86



1/4" 6,3

Code	Art.-No.								
1513834	4002.42								50





1/4" 6,3

Code	Art.-No.		
1519395	7200.00tk		78





1/4" 6,3 6,3 **5°**
72 Zähne/Teeth

Code	Art.-No.	
1519433	7200.30	68





1/4" 6,3 6,3

Code	Art.-No.	
1519409	7200.25	64

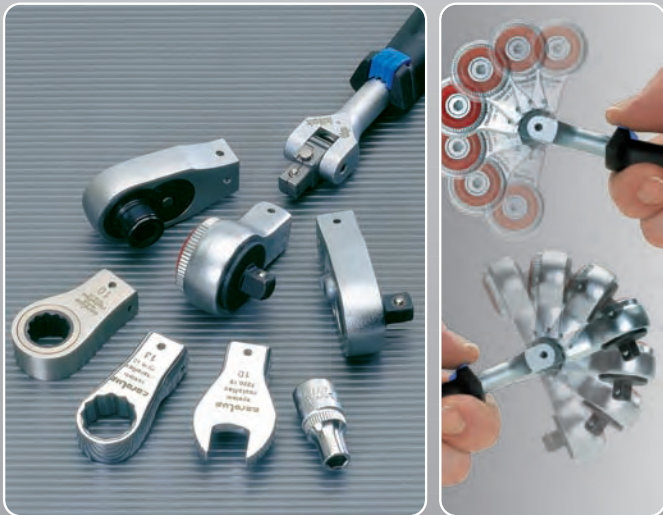

1/4" 6,3 6,3

Code	Art.-No.	
1519417	7200.26	66



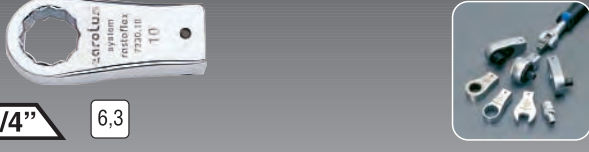

1/4" 6,3

Code	Art.-No.	mm	
1519557	7220.08	8	24
1519565	7220.09	9	22
1519581	7220.10	10	22
1519603	7220.11	11	28
1519611	7220.12	12	30
1519638	7220.13	13	32



1/4" 6,3

Code	Art.-No.	mm	
1519670	7230.08	8	28
1519689	7230.09	9	28
1519697	7230.10	10	28
1519700	7230.11	11	30
1519719	7230.12	12	30
1519727	7230.13	13	28



1/4" 6,3

Code	Art.-No.	mm	
1519476	7210.08	8	20
1519484	7210.09	9	36
1519492	7210.10	10	34
1519506	7210.11	11	36
1519514	7210.12	12	42
1519522	7210.13	13	42

3

3



1/4" **6,3**

4177.20

Code	Art.-No.								
1515411	4177.25								29



1/4" **6,3**

7225.00

Code	Art.-No.								
1851640	4177.27								29

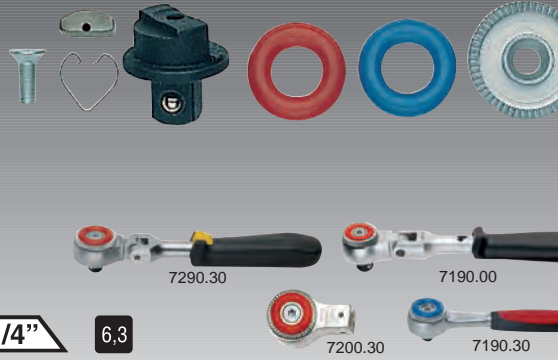

1/4" **6,3**

7290.30 7190.00 7200.30 7190.30

5°
72 Zähne/Teeth

Code	Art.-No.								
1519387	7190.35								34

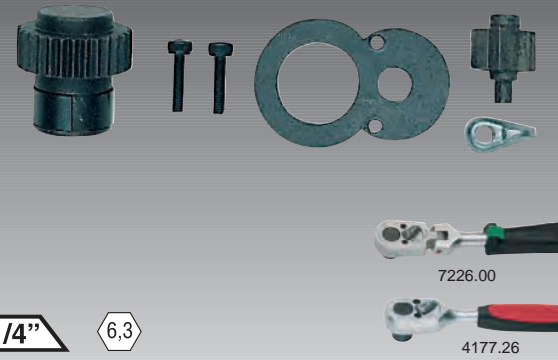

1/4" **6,3**

7226.00 4177.26

Code	Art.-No.								
1519360	7126.10								28



1/4" **6,3**

4170.00

5°
72 Zähne/Teeth

Code	Art.-No.								
1837362	4170.00								74



3/8" 10

Code	Art.-No.	mm	L mm	D1 mm	D2 mm	⚖
1517708	6100.08	8	26	25	9,8	23
1517716	6100.10	10	26	25	10,5	26
1517724	6100.11	11	26	25	11,6	26
1517732	6100.12	12	26	25	14,4	27
1517740	6100.13	13	26	25	15	30
1517759	6100.14	14	26	25	16,7	28
1517767	6100.15	15	26	25	17,9	43
1517775	6100.16	16	26	25	19	39
1517783	6100.17	17	30	30	22,2	50
1517791	6100.18	18	30	30	24,5	55
1517805	6100.19	19	30	30	26,3	60
1517813	6100.22	22	30	30	30	66
1517821	6100.24	24	30			70

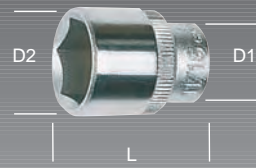

3/8" 10 ZOLL / Inches

Code	Art.-No.	ZOLL / inches	L mm	D1 mm	D2 mm	⚖
1518070	6200.01	1/4"	26	17	10	23
1518089	6200.02	5/16"	26	17	12	21
1518097	6200.03	3/8"	26	17	14,5	26
1518100	6200.04	7/16"	26	17	16	31
1518119	6200.05	1/2"	26	17	18	30
1518127	6200.06	9/16"	26	17	20	34
1518135	6200.07	5/8"	26	18	22	40
1518143	6200.08	11/16"	30	18,5	24,5	50
1518151	6200.09	3/4"	30	20,3	26	55



3/8" 10

Code	Art.-No.		L mm	D1 mm	D2 mm	⚖
1518178	6300.04	E 4	26	17	5,5	23
1518186	6300.05	E 5	26	17	6,0	23
1518194	6300.06	E 6	26	17	8,0	21
1518208	6300.07	E 7	26	17	9	24
1518216	6300.08	E 8	26	17	10	23
1518224	6300.10	E10	26	17	12	25
1518232	6300.12	E12	26	17	14,5	28
1518240	6300.14	E14	26	17	16	29
1518259	6300.16	E16	26	17	18	30



3/8" 10

Code	Art.-No.	mm	L mm	6kt. mm	D2 mm	⚖
1517449	6080.16	16	70	17	21	90
1517457	6080.21	20,8	70	22	27	140

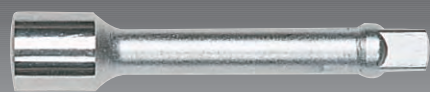

3/8" 10 10

Code	Art.-No.	mm	⚖
1517902	6150.45	45	50
1517899	6150.15	150	110



3/8" 10 10

Code	Art.-No.	mm	⚖
1850458	6151.15	125	152
1850466	6151.25	250	244
1850474	6151.30	300	291



3/8" 10 10

Code	Art.-No.				⚖️
1517880	6130.00				60



3/8" 10 ○

Code	Art.-No.	mm			⚖️
1517368	6060.13	13			70
1517376	6060.15	15			80
1517384	6060.17	17			90



3/8" 10 8 3/8" □ x 5/16" ◻

Code	Art.-No.				⚖️
1517406	6070.10				36



3/8" 10 8 3/8" ■ x 5/16" ◻

Code	Art.-No.				⚖️
1517392	6070.00				20



3/8" 10 6,3 3/8" □ x 1/4" ◻

Code	Art.-No.				⚖️
1517430	6070.60				32

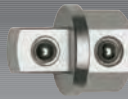

3/8" 10 3/8" ■ x 15 mm ◻

Code	Art.-No.				⚖️
1517159	6015.15				26



3/8" 10

Code	Art.-No.				⚖️
1517848	6120.10				72



3/8" 10

Code	Art.-No.				⚖️
1696548	6120.25				72



3/8" 6,3 6190.00 6190.30 6290.00

Code	Art.-No.				⚖️
1518054	6190.35				52



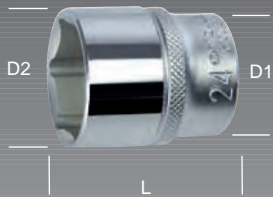

1/2" 12,5

Code	Art.-No.	mm	L mm	D1 mm	D2 mm	Ø ₉₀
1516329	5100.10	10	36	22	15	50
1516345	5100.11	11	36	22	16,3	50
1516353	5100.12	12	36	22	17,6	50
1516388	5100.13	13	36	22	18,8	50
1516418	5100.14	14	36	22	20,4	50
1516426	5100.15	15	36	22	21	60
1516434	5100.16	16	36	21,5	23	60
1516442	5100.17	17	36	22,3	24	70
1516450	5100.18	18	36	23,5	26	80
1516469	5100.19	19	36	23,8	27	80
1516477	5100.20	20	36	23,8	28	90
1516485	5100.21	21	36	26	29	100
1516493	5100.22	22	36	26,8	30	100
1516507	5100.23	23	36	26,8	31	110
1516515	5100.24	24	36	28	32	120
1516523	5100.26	26	36	28	35	130
1516531	5100.27	27	40	30	36	150
1516558	5100.28	28	40	30	37	150
1516566	5100.30	30	40	32	40	180
1516574	5100.32	32	40	34	42	200



1/2" 10 ZOLL / Inches

Code	Art.-No.	ZOLL / inches	L mm	D1 mm	D2 mm	Ø ₉₀
1850695	5111.01	5/16"	36	22	12	40
1850709	5111.02	3/8"	36	22	14	42
1850717	5111.03	13/32"	36	22	15,5	42
1850725	5111.04	7/16"	36	22	16,5	42
1850733	5111.05	1/2"	36	22	18,8	46
1850741	5111.06	9/16"	36	22	20,4	49
1850768	5111.07	19/32"	36	22	21	48
1850776	5111.08	5/8"	36	21,5	22	47
1850784	5111.09	11/16"	36	23	24	61
1850792	5111.10	3/4"	36	23,8	27	75
1850806	5111.11	25/32"	36	23,8	28	71
1850814	5111.12	13/16"	36	26	28	82
1850822	5111.13	7/8"	36	26,8	30	89
1850830	5111.14	15/16"	36	28	32	96
1939173	5111.19	1"	36	28	35	100
1850849	5111.15	1-1/16"	40	30	36	137
1850857	5111.16	1-1/8"	40	30	38	145
1850865	5111.17	1-3/16"	40	32	40	162
1850873	5111.18	1-1/4"	40	34	42	184

3

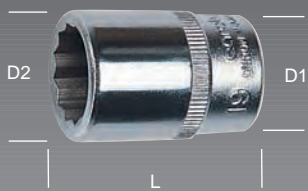

1/2" 12,5

Code	Art.-No.	mm	L mm	D1 mm	D2 mm	Ø ₉₀
1850482	5112.10	10	36	22	15	42
1850490	5112.11	11	36	22	16,3	42
1854976	5112.12	12	36	22	17,6	44
1850504	5112.13	13	36	22	18,8	46
1850512	5112.14	14	36	22	20,4	50
1850520	5112.15	15	36	22	21	50
1850539	5112.16	16	36	21,5	22	45
1850547	5112.17	17	36	22,3	24	59
1850555	5112.18	18	36	23,5	26	75
1850563	5112.19	19	36	23,8	27	71
1850571	5112.20	20	36	23,8	28	75
1850598	5112.21	21	36	26	29	88
1850601	5112.22	22	36	26,8	30	91
1850628	5112.23	23	36	26,8	31	91
1850636	5112.24	24	36	28	32	100
1850644	5112.26	26	36	28	35	113
1850652	5112.27	27	40	30	36	141
1850660	5112.28	28	40	30	37	144
1850679	5112.30	30	40	32	40	162
1850687	5112.32	32	40	34	42	179



1/2" 12,5

Code	Art.-No.	mm	L mm	D1 mm	D2 mm	Ø ₉₀
1848690	5106.10	10	77	22	15	67
1848704	5106.12	12	77	22	17,6	86
1848712	5106.13	13	77	22	18,8	96
1848720	5106.14	14	77	22	20,4	100
1848739	5106.15	15	77	22	21	98
1848747	5106.17	17	77	22	24	121
1848755	5106.19	19	77	22	27	150
1848763	5106.21	21	77	26	30	208
1848771	5106.22	22	77	26	30	195
1848798	5106.23	23	77	26	32	229
1848801	5106.24	24	77	26	34	256
1848828	5106.27	27	77	28	36	281
1848836	5106.30	30	77	28	40	283
1848844	5106.32	32	77	28	42	310



Code	Art.-No.	mm	L mm			⚙️
1696025	5180.16	16	70			90
1696033	5180.21	20,8	70			140

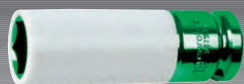

85 mm



Code	Art.-No.	mm				⚙️
1854186	5575.15	15				167



Code	Art.-No.	mm	L mm	D1 mm	D2 mm	⚙️
1849077	5300.10	E10	38	22	13	52
1849085	5300.11	E11	38	22	14	53
1849093	5300.12	E12	38	22	15	53
1849107	5300.14	E14	38	22	16	53
1849115	5300.16	E16	38	22	19	57
1849123	5300.18	E18	38	22	20	54
1849131	5300.20	E20	38	22	23	61
1849158	5300.22	E22	38	22	26	78
1849166	5300.24	E24	40	23	28	94



Code	Art.-No.	mm	L mm	D1 mm	D2 mm	⚙️
1849247	5430.06	E6	38	25	9,8	63
1849255	5430.07	E7	38	25	10,5	63
1849263	5430.08	E8	38	25	11,6	67
1849271	5430.10	E10	38	25	14,4	71
1849298	5430.11	E11	38	25	15	69
1849301	5430.12	E12	38	25	16,7	74
1849328	5430.14	E14	38	25	17,9	74
1849336	5430.16	E16	38	25	19	74
1849344	5430.18	E18	38	30	22,2	119
1849352	5430.20	E20	38	30	24,5	122
1849360	5430.22	E22	38	30	26,3	125
1849379	5430.24	E24	42	30	30	152



Code	Art.-No.	mm	L mm	D1 mm	D2 mm	⚙️
1849387	5400.10	10	38	25	16,2	69
1849395	5400.11	11	38	25	17,5	72
1849409	5400.12	12	38	25	19,1	73
1849417	5400.13	13	38	25	20	73
1849425	5400.14	14	38	25	22	77
1849433	5400.15	15	38	25	23	78
1849441	5400.16	16	38	25	25	81
1849468	5400.17	17	38	26	26	88
1849476	5400.19	19	38	28	28	96
1849484	5400.21	21	38	30	30	116
1849492	5400.22	22	43	30	33	152
1849506	5400.24	24	43	30	35	153
1849514	5400.27	27	45	30	39	175
1849522	5400.30	30	48	30	43	240
1849530	5400.32	32	48	30	45	230



Code	Art.-No.	mm	L mm	D1 mm	D2 mm	⚙️
1849549	5406.10	10	85	25	16,2	124
1849557	5406.11	11	85	25	17,5	133
1849565	5406.12	12	85	25	19,1	148
1849573	5406.13	13	85	25	20	153
1849581	5406.14	14	85	25	22	176
1849603	5406.15	15	85	25	23	178
1849611	5406.16	16	85	25	25	205
1849638	5406.17	17	85	26	26	224
1849646	5406.19	19	85	28	28	244
1849654	5406.21	21	85	30	30	269
1849662	5406.22	22	85	30	33	331
1849670	5406.24	24	85	30	35	352





1/2" 12,5

Code	Art.-No.	mm	L mm	⚖️
1829319	5135.05	5	60	63
1829327	5135.06	6	60	64
1829335	5135.07	7	60	67
1829343	5135.08	8	60	68
1829394	5135.09	9	60	80
1829351	5135.10	10	60	80
1829408	5135.11	11	60	109
1829378	5135.12	12	60	112
1829416	5135.14	14	60	138
1829424	5135.17	17	60	171



1/2" 12,5

Code	Art.-No.	mm	L mm	⚖️
1848887	5136.05	5	80	72
1848909	5136.06	6	80	72
1848917	5136.08	8	80	82



1/2" 12,5

Code	Art.-No.	mm	L mm	⚖️
1848976	5138.07	7	100	84



1/2" 12,5

Code	Art.-No.	mm	L mm	⚖️
1849689	5139.08	8	120	94



1/2" 12,5

Code	Art.-No.	mm	L mm	⚖️
1848984	5141.06	6	140	85
1848992	5141.10	10	140	133
1849018	5141.12	12	140	189
1849026	5141.14	14	140	242



1/2" 12,5

Code	Art.-No.	mm	L mm	⚖️
1849034	5142.05	5	180	115



1/2" 12,5

Code	Art.-No.		L mm	D1 mm	⚖️
1849174	5303.30	TX30	55	22	63
1849182	5303.40	TX40	55	22	63
1849190	5303.45	TX45	55	22	67
1849204	5303.50	TX50	55	22	67
1849212	5303.55	TX55	55	22	77
1849220	5303.60	TX60	55	24	106
1849239	5303.70	TX70	55	24	129



1/2" 12,5 12,5

Code	Art.-No.	mm	⚖️
1516647	5150.75	75	130
1516620	5150.12	125	190
1516639	5150.25	250	340



1/2" 12,5 12,5

Code	Art.-No.	mm					
1849042	5151.12	125					240
1849050	5151.25	250					440
1849069	5151.37	375					470



1/2" 12,5 12,5

Code	Art.-No.						
1516604	5130.00						140



1/2" 12,5

Code	Art.-No.						
1516612	5140.00						380

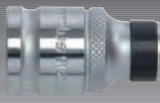

1/2" 12,5 8 1/2" □ x 5/16" ○

Code	Art.-No.						
1516655	5160.00						60

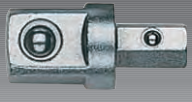

1/2" 12,5 8 1/2" ■ x 5/16" ●

Code	Art.-No.						
1517422	6070.50						37

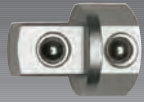

1/2" 12,5 1/2" ■ x 19mm ●

Code	Art.-No.						
1597124	5115.19						52



1/2" 12,5 5125.00

Code	Art.-No.						
1516582	5120.10						158



1/2" 12,5 5190.20 5225.00

Code	Art.-No.						
1696017	5120.25						158



1/2" 12,5 5190.00 5190.30 5290.00

Code	Art.-No.						
1516728	5190.35						116

5°
72 Zähne/Teeth

3

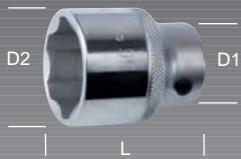

3/4" 20

Code	Art.-No.	mm	L mm	D1 mm	D2 mm	⌀ ₉₀
1683276	8100.19	19	51	36	30	120
1683292	8100.21	21	51	36	32	240
1683306	8100.22	22	51	36	33	160
1683314	8100.24	24	51	36	34	180
1683322	8100.27	27	55	36	40	250
1683330	8100.30	30	58	38	43	350
1683349	8100.32	32	56	36	43	380
1683357	8100.33	33	58	40	47	400
1683365	8100.36	36	58	36	50	450
1683373	8100.38	38	60	40	53	460
1683381	8100.41	41	62	44	57	500
1683403	8100.46	46	66	44	63	570
1683411	8100.50	50	69	48	68	650
1683438	8100.55	55	68	53	75	750
1683446	8100.60	60	68	53	81	850



3/4" 20

Code	Art.-No.	mm	L mm	D1 mm	D2 mm	⌀ ₉₀
1852086	8106.17	17	50	44	30	327
1852094	8106.18	18	50	44	32	340
1852108	8106.19	19	50	44	32	340
1852116	8106.22	22	50	44	37	353
1852124	8106.24	24	50	44	39	355
1852132	8106.26	26	50	44	42	378
1852140	8106.27	27	54	44	43	388
1852167	8106.29	29	54	44	45	403
1852175	8106.30	30	54	44	47	432
1852183	8106.32	32	57	44	49	473
1852191	8106.33	33	57	44	50	483
1852205	8106.34	34	57	44	52	506
1852213	8106.35	35	57	44	53	508
1852221	8106.36	36	57	44	54	515
1852248	8106.38	38	57	44	57	565
1852256	8106.41	41	57	44	60	591



3/4" 20 25 3/4" □ x 1" ■

Code	Art.-No.	⌀ ₉₀
1683497	8160.00	300

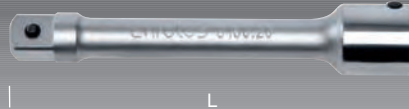

3/4" 20 20

Code	Art.-No.	L mm	⌀ ₉₀
1683470	8150.20	200	600
1683462	8150.40	400	1100



3/4" 20 20

Code	Art.-No.	⌀ ₉₀
1683489	8130.00	550





3/4" 20

Code	Art.-No.	⌀ ₉₀
1683454	8140.00	1150

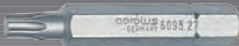

3





5/16"  



Code	Art.-No.		L mm		
1517465	6095.20	TX20	50		20
1517473	6095.25	TX25	50		21
1517481	6095.27	TX27	50		22
1517503	6095.30	TX30	50		22
1517511	6095.40	TX40	50		22
1517538	6095.45	TX45	50		24
1517546	6095.50	TX50	50		24
1517554	6095.55	TX55	50		40
1517562	6095.60	TX60	50		50





5/16"  



Code	Art.-No.		L mm		
1517678	6098.40	TX40	100		47
1517686	6098.45	TX45	100		48
1517694	6098.55	TX55	100		80



5/16"  



Code	Art.-No.		L mm		
1517570	6096.20	TX20	50		21
1517589	6096.25	TX25	50		21
1517597	6096.27	TX27	50		22
1517600	6096.30	TX30	50		22
1517619	6096.40	TX40	50		22
1517627	6096.45	TX45	50		23
1517635	6096.50	TX50	50		24
1517643	6096.55	TX55	50		38
1517651	6096.60	TX60	50		48



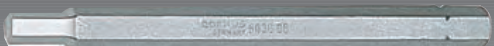

5/16"  



Code	Art.-No.	mm	L mm		
1517031	6035.04	4	50		20
1517058	6035.05	5	50		22
1517066	6035.06	6	50		23
1517074	6035.07	7	50		24
1517082	6035.08	8	50		25
1517090	6035.10	10	50		35
1517104	6035.12	12	50		46
1517112	6035.14	14	50		60





5/16"  

Code	Art.-No.	mm	L mm		
1517120	6038.04	4	100		45
1517139	6038.05	5	100		45
1517147	6038.06	6	100		47
1517155	6038.07	7	100		48
1517163	6038.08	8	100		50
1517171	6038.10	10	100		60



5/16"  

Code	Art.-No.	mm	L mm		
1517295	6055.04	4	50		20
1517309	6055.05	5	50		21
1517317	6055.06	6	50		22
1517325	6055.07	7	50		23
1517333	6055.08	8	50		24
1517341	6055.10	10	50		31



5/16" 8

Code	Art.-No.	mm	L mm	⚖
1517198	6045.05	5	50	21
1517201	6045.06	6	50	22
1517228	6045.08	8	50	24
1517236	6045.10	10	50	30
1517244	6045.12	12	50	39



5/16" 8

Code	Art.-No.	mm	L mm	⚖
1517252	6048.06	6	100	47
1517260	6048.08	8	100	48
1517279	6048.10	10	100	60
1517287	6048.12	12	100	80

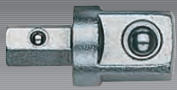

5/16" 8 12,5 5/16" x 1/2"

Code	Art.-No.	⚖
1517422	6070.50	37



5/16" 8 10 5/16" x 3/8"

Code	Art.-No.	⚖
1517392	6070.00	20

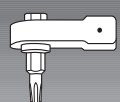
5/16" 8 5/16" x 13mm

Code	Art.-No.	⚖
1597140	6015.13	32



5/16" 8 8 5/16" x 5/16"

Code	Art.-No.	⚖
1517414	6070.40	60









5/16" 8 12,5 5/16" x 1/2"

Code	Art.-No.	⚖
1516655	5160.00	60



5/16" 8 10 5/16" x 3/8"

Code	Art.-No.	⚖
1517406	6070.10	36





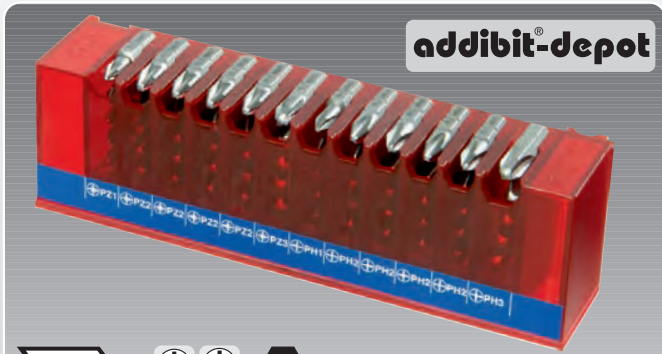

5/16" 8 6126.00 6190.40

Code	Art.-No.	⚖
1517872	6126.25	60



addibit[®]-depot

1/4"   

-  5 x PZ 1  5 x PH 1
-  20 x PZ 2  20 x PH 2
-  5 x PZ 3  5 x PH 3

Code	Art.-No.	mm		
1824880	3000.21	152 x 31 x 46	1	400



addibit[®]-depot

1/4"  



-  3 x TX 10  9 x TX 25
-  3 x TX 15  9 x TX 30
-  3 x TX 20  9 x TX 40

Code	Art.-No.	mm		
1656635	3000.40	152 x 31 x 46	1	280



addibit[®]-depot

1/4"  





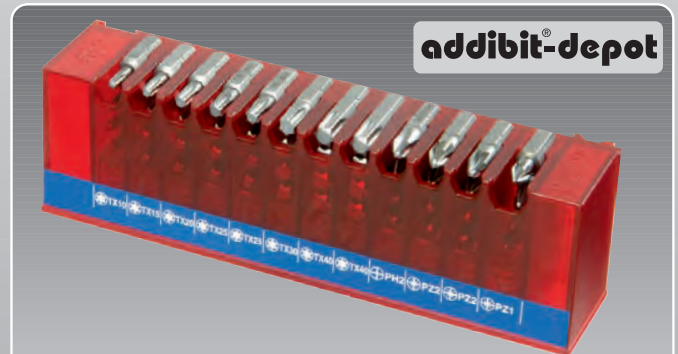



-  9 x PZ 1
-  18 x PZ 2
-  9 x PZ 3

Code	Art.-No.	mm		
1656678	3000.60	152 x 31 x 46	1	280



addibit[®]-depot

1/4"    



-  5 x TX 10  10 x TX 25  5 x PZ 1
-  5 x TX 15  5 x TX 30  10 x PZ 2
-  5 x TX 20  10 x TX 40  5 x PH 2

Code	Art.-No.	mm		
1824902	3000.71	152 x 31 x 46	1	405



addibit[®]-depot plus

1/4"  

-  15 x PZ 1
-  40 x PZ 2
-  5 x PZ 3

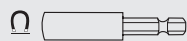







1/4"  x 1/4" 

Code	Art.-No.	mm		
1513567	3900.10	151 x 33 x 64	1	570





addibit[®]-depot plus

1/4"   

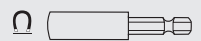
-  5 x PZ 1  5 x PH 1
-  20 x PZ 2  20 x PH 2
-  5 x PZ 3  5 x PH 3







1/4"  x 1/4" 

Code	Art.-No.	mm		
1513613	3900.20	151 x 33 x 64	1	574

addibit®-depot plus



1/4"     **6,3**

- 5 x TX 10
- 5 x TX 15
- 5 x TX 20
- 5 x TX 25
- 5 x TX 27
- 5 x TX 30
- 5 x TX 40
- 5 x PH 2
- 5 x PZ 2
- 5 x 4mm
- 5 x 5mm
- 5 x 6mm

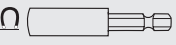
 1/4" x 1/4"

Code	Art.-No.	mm		
1513648	3900.30	151 x 33 x 64	1	590

addibit®-depot plus



1/4"  **6,3**

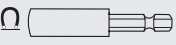

- 5 x TX 10
- 5 x TX 15
- 5 x TX 20
- 5 x TX 25
- 5 x TX 27
- 5 x TX 30
- 5 x TX 40

 1/4" x 1/4"

Code	Art.-No.	mm		
1513656	3900.40	151 x 33 x 64	1	442

addibit®-depot plus



1/4"    **6,3**

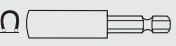

- 5 x PZ 1
- 20 x PZ 2
- 5 x PZ 3
- 5 x TX 10
- 5 x TX 15
- 5 x TX 20
- 5 x TX 25
- 5 x 5,5
- 5 x 6,5

 1/4" x 1/4"

Code	Art.-No.	mm		
1513672	3900.50	151 x 33 x 64	1	568

addibit®-depot plus



1/4"    **6,3**

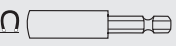

- 5 x TX 10
- 5 x TX 15
- 5 x TX 20
- 5 x TX 25
- 5 x PZ 1
- 20 x PZ 2
- 5 x PZ 3
- 5 x PH 2
- 5 x PH 3

 1/4" x 1/4"

Code	Art.-No.	mm		
1513680	3900.60	151 x 33 x 64	1	568

addibit®-depot plus



1/4"    **6,3**

- 5 x PZ 1
- 10 x PZ 2
- 5 x PH 2
- 5 x TX 10
- 5 x TX 15
- 5 x TX 20
- 10 x TX 25
- 5 x TX 30
- 10 x TX 40

 1/4" x 1/4"

Code	Art.-No.	mm		
1513699	3900.70	151 x 33 x 64	1	582

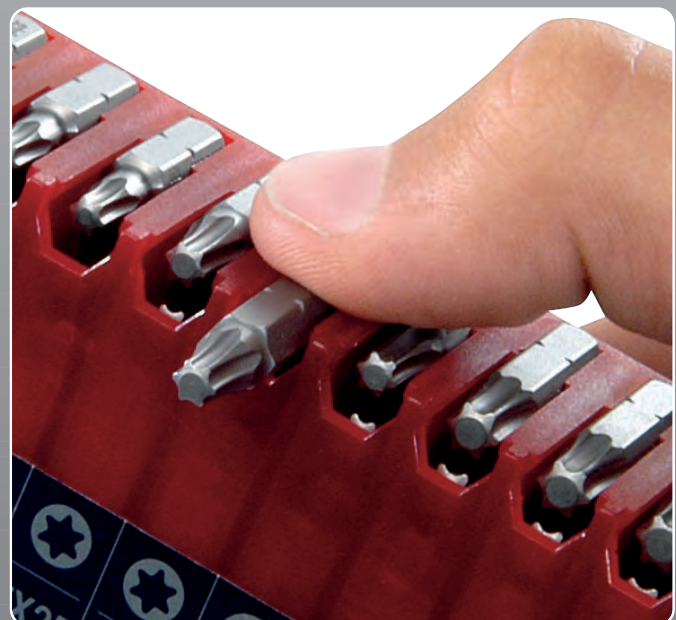



bit-accu®

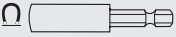

1/4"  **6,3**

- 2 x TX 10
- 2 x TX 15
- 2 x TX 20
- 2 x TX 25
- 2 x TX 27
- 2 x TX 30
- 2 x TX 40
- 2 x 4mm
- 2 x 5mm
- 2 x 6mm
- 2 x PH 2
- 2 x PZ 2



1/4"  x 1/4" 

Code	Art.-No.	mm		
1519050	6926.30	245 x 47 x 24	1	440



bit-accu®



1/4"

Code	Art.-No.	mm		
1519026	6926.00	245 x 47 x 24	1	312



carolus
Artikel-Nr. 3000.07

1/4" 

- 1 x TX 10
- 1 x TX 15
- 1 x TX 20
- 1 x TX 25
- 1 x TX 30
- 1 x TX 40
- 1 x Magnethalter 1/4"

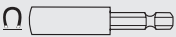

1/4"  x 1/4" 

Code	Art.-No.	mm		
1890387	3000.07	72 x 51 x 16	10	85



carolus
Artikel-Nr. 3000.08



1/4" 

- 1 x PH 1
- 1 x PH 2
- 1 x PH 3
- 1 x FL 0,6 x 4,5
- 1 x FL 0,8 x 5,5
- 1 x FL 1,2 x 6,5
- 1 x Magnethalter 1/4"



1/4"  x 1/4" 

Code	Art.-No.	mm		
1890395	3000.08	72 x 51 x 16	10	85





5



Code	Art.-No.	mm	mm	g
1848410	1500.08	8	140	60
1848429	1500.09	9	150	80
1848437	1500.10	10	160	90
1848445	1500.11	11	165	100
1848453	1500.12	12	170	70
1848461	1500.13	13	180	80
1848488	1500.14	14	190	102
1848496	1500.15	15	200	121
1848518	1500.16	16	210	144
1848526	1500.17	17	220	173
1848534	1500.18	18	230	200
1848542	1500.19	19	245	210
1848550	1500.22	22	290	340
1848569	1500.24	24	320	460
1848577	1500.27	27	360	650
1848585	1500.30	30	400	890
1848593	1500.32	32	425	1045
1848607	1500.34	34	460	1195
1848615	1500.36	36	490	1445

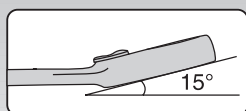
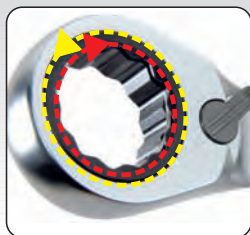

1/4" ■ x 10mm ●

3/8" ■ x 15mm ●

1/2" ■ x 19mm ●

1/4" ○ x 8mm ●

5/16" ○ x 13mm ●

5



8 · 10 · 12 · 13 · 15 · 17 · 19 mm

1/2" ■ x 19mm ● · 3/8" ■ x 15mm ● · 1/4" ■ x 10mm ●

5/16" ○ x 13mm ● · 1/4" ○ x 8mm ●

Code	Art.-No.	mm	g
1597175	1507.00	325 x 180 x 45	2308



8 · 9 · 10 · 11 · 12 · 13 · 14 · 15 · 16 · 17 · 18 · 19 mm

1/2" ■ x 19mm ● · 3/8" ■ x 15mm ● · 1/4" ■ x 10mm ●

5/16" ○ x 13mm ● · 1/4" ○ x 8mm ●

Code	Art.-No.	mm	g
1597167	1512.00	325 x 180 x 45	2900



○ 8 · 9 · 10 · 11 · 12 · 13 · 15 · 16 · 17 mm

✦ E 8 · E10 · E11 · E12 · E14 · E16 · E18 · E20 · E22

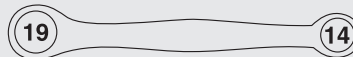

Code
1892266



Art.-No.
1520.00

mm
235 x 100 x 35



g
664







Code	Art.-No.	Ø mm	← mm		
1655574	0106.07	6 x 7	170	10	60
1655582	0108.09	8 x 9	182	10	70
1846469	0108.10	8 x 10	182	10	70
1655590	0110.11	10 x 11	185	10	70
1655604	0110.13	10 x 13	212	10	120
1655612	0112.13	12 x 13	212	10	130
1655620	0113.15	13 x 15	225	10	160
1655639	0113.17	13 x 17	246	10	200
1655647	0114.15	14 x 15	225	10	160
1655655	0116.17	16 x 17	245	10	220
1846477	0116.18	16 x 18	270	10	270
1655663	0117.19	17 x 19	265	10	280
1655671	0118.19	18 x 19	265	10	270
1655698	0119.22	19 x 22	287	10	340
1655701	0120.22	20 x 22	287	10	360
1655728	0121.23	21 x 23	305	10	400
1655736	0122.24	22 x 24	307	10	430
1655752	0124.26	24 x 26	325	10	460
1655760	0124.27	24 x 27	325	10	500
1846485	0124.30	24 x 30	350	10	600
1655779	0125.28	25 x 28	345	10	580
1846493	0127.30	27 x 30	350	10	600
1655795	0127.32	27 x 32	370	10	700
1655817	0130.32	30 x 32	370	10	720
1846507	0132.36	32 x 36	410	10	880
1655825	0136.41	36 x 41	440	10	1210



Code	Art.-No.	Ø mm		
1693948	0100.08	6x7 - 8x9 - 10x11 - 12x13 - 14x15 - 16x17 - 18x19 - 20x22	1	1400
1693972	0100.10	6x7 - 8x9 - 10x11 - 12x13 - 14x15 - 16x17 - 18x19 - 20x22 - 21x23 - 24x27	1	2200
1693980	0100.100	6x7 - 8x9 - 10x11 - 12x13 - 14x15 - 16x17 - 18x19 - 20x22 - 24x27 - 30x32	1	2750
1693999	0100.12	6x7 - 8x9 - 10x11 - 12x13 - 14x15 - 16x17 - 18x19 - 20x22 - 21x23 - 24x26 - 25x28 - 27x32	1	3500
1694006	0100.120	6x7 - 8x9 - 10x11 - 12x13 - 14x15 - 16x17 - 18x19 - 20x22 - 21x23 - 24x27 - 25x28 - 30x32	1	3550



Code	Art.-No.	Ø mm		
1693964	0100.08VK	6x7 - 8x9 - 10x11 - 12x13 - 14x15 - 16x17 - 18x19 - 20x22	1	1400
1694014	0100.120VK	6x7 - 8x9 - 10x11 - 12x13 - 14x15 - 16x17 - 18x19 - 20x22 - 21x23 - 24x27 - 25x28 - 30x32	1	3550

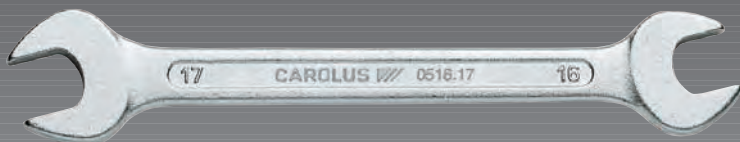

Code	Art.-No.	mm	mm		
1655833	0506.07	6 x 7	122	10	25
1655841	0508.09	8 x 9	140	10	40
1846515	0508.10	8 x 10	140	10	40
1655868	0510.11	10 x 11	157	10	50
1655876	0510.13	10 x 13	172	10	70
1655884	0512.13	12 x 13	172	10	70
1846523	0512.14	12 x 14	172	10	75
1846531	0513.14	13 x 14	177	10	80
1655892	0513.15	13 x 15	188	10	90
1655906	0513.17	13 x 17	205	10	110
1655914	0514.15	14 x 15	188	10	110
1655930	0516.17	16 x 17	205	10	120
1846558	0516.18	16 x 18	205	10	130
1655949	0517.19	17 x 19	222	10	160
1655957	0518.19	18 x 19	222	10	190
1655965	0519.22	19 x 22	236	10	200
1655973	0520.22	20 x 22	236	10	250
1655981	0521.23	21 x 23	247	10	270
1656015	0522.24	22 x 24	250	10	250
1656023	0524.26	24 x 26	266	10	350
1656031	0524.27	24 x 27	266	10	360
1846566	0524.30	24 x 30	280	10	395
1656058	0525.28	25 x 28	280	10	360
1846574	0527.30	27 x 30	301	10	475
1656066	0527.32	27 x 32	302	10	540
1656074	0530.32	30 x 32	302	10	530
1846582	0532.36	32 x 36	320	10	650
1656104	0536.41	36 x 41	380	10	830

5



Code	Art.-No.	mm		
1694324	0500.08	6x7 - 8x9 - 10x11 - 12x13 - 14x15 - 16x17 - 18x19 - 20x22	1	700
1694340	0500.10	6x7 - 8x9 - 10x11 - 12x13 - 14x15 - 16x17 - 18x19 - 20x22 - 21x23 - 24x27	1	1250
1694359	0500.100	6x7 - 8x9 - 10x11 - 12x13 - 14x15 - 16x17 - 18x19 - 20x22 - 24x27 - 30x32	1	1800
1694367	0500.12	6x7 - 8x9 - 10x11 - 12x13 - 14x15 - 16x17 - 18x19 - 20x22 - 21x23 - 24x26 - 25x28 - 27x32	1	2100
1694375	0500.120	6x7 - 8x9 - 10x11 - 12x13 - 14x15 - 16x17 - 18x19 - 20x22 - 21x23 - 24x27 - 25x28 - 30x32	1	2150



Code	Art.-No.	mm		
1694332	0500.08VK	6x7 - 8x9 - 10x11 - 12x13 - 14x15 - 16x17 - 18x19 - 20x22	1	700
1694383	0500.120VK	6x7 - 8x9 - 10x11 - 12x13 - 14x15 - 16x17 - 18x19 - 20x22 - 21x23 - 24x27 - 25x28 - 30x32	1	2100



Code	Art.-No.	mm	mm		
1655302	0900.06	6	100	10	16
1655329	0900.07	7	110	10	21
1655337	0900.08	8	120	10	25
1655345	0900.09	9	130	10	31
1655353	0900.10	10	140	10	35
1655361	0900.11	11	150	10	35
1655388	0900.12	12	160	10	50
1655396	0900.13	13	170	10	65
1655418	0900.14	14	180	10	75
1655426	0900.15	15	190	10	90
1655434	0900.16	16	200	10	105
1655442	0900.17	17	210	10	120
1655450	0900.18	18	220	10	155
1655469	0900.19	19	230	10	170
1655477	0900.20	20	240	10	200
1655485	0900.21	21	262	10	210
1655493	0900.22	22	262	10	220
1655507	0900.24	24	282	10	300
1655515	0900.27	27	310	10	400
1655531	0900.30	30	340	10	500
1655558	0900.32	32	370	10	700
1655566	0900.34	34	420	10	950

5



Code	Art.-No.	mm		
1694634	0900.080	8 - 9 - 10 - 11 - 13 - 14 - 17 - 19	1	600
1694650	0900.090	6 - 7 - 8 - 10 - 11 - 13 - 14 - 17 - 19	1	650
1694669	0900.100	8 - 10 - 11 - 12 - 13 - 14 - 15 - 17 - 19 - 22	1	850
1694677	0900.110	7 - 8 - 10 - 11 - 12 - 13 - 14 - 16 - 17 - 18 - 19	1	700
1694685	0900.112	6 - 7 - 8 - 9 - 10 - 11 - 12 - 13 - 14 - 15 - 17 - 19	1	750
1813544	0900.117	6 - 7 - 8 - 9 - 10 - 11 - 12 - 13 - 14 - 15 - 16 - 17 - 18 - 19 - 20 - 21 - 22	1	1580
1694693	0900.120	10 - 11 - 12 - 13 - 14 - 15 - 17 - 19 - 22 - 24 - 27 - 30	1	1800
1694707	0900.122	10 - 11 - 12 - 13 - 14 - 17 - 19 - 22 - 24 - 27 - 30 - 32	1	2530
1813552	0900.210	6 - 7 - 8 - 9 - 10 - 11 - 12 - 13 - 14 - 15 - 16 - 17 - 18 - 19 - 20 - 21 - 22 - 24 - 27 - 30 - 32	1	3325



Code	Art.-No.	mm		
1694642	0900.080VK	8 - 9 - 10 - 11 - 13 - 14 - 17 - 19	1	600
1694715	0900.120VK	10 - 11 - 12 - 13 - 14 - 15 - 17 - 19 - 22 - 24 - 27 - 30	1	1800
1694723	0900.122VK	10 - 11 - 12 - 13 - 14 - 17 - 19 - 22 - 24 - 27 - 30 - 32	1	2500



Code	Art.-No.	mm		
1694278	0300.15	155	10	120
1694286	0300.20	205	10	240
1694294	0300.25	255	10	420



Code	Art.-No.			
1683233	0400.00	17 x 19 (3/4") x 21 x 11/16"	10	1200



Code	Art.-No.		mm		
1680862	0450.00		215	10	195
1782312	0450.01			10	

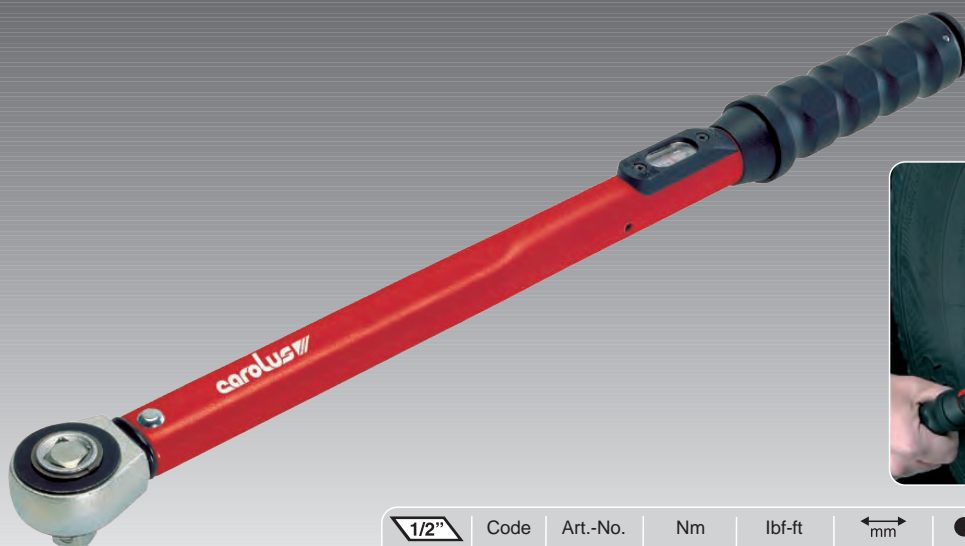

1/2"	Code	Art.-No.	Nm	lbf-ft	mm	mm	kg	kg
	1677357	5900.10	10 - 100	8 - 75	395	44	1	1000
	1677365	5900.20	20 - 200	15 - 150	485	44	1	1250
	1677373	5900.60	60 - 300	45 - 220	575	44	1	1450

Anzugsmomente für Radmuttern und Radschrauben von Nutzfahrzeugen, Serien

LKW (Alu-Felgen Herstellerangaben beachten!)

5

Fahrzeugmarke	Gewinde	Anzugswert N-m	Anzugswert N-m	Fahrzeugmarke	Gewinde	Anzugswert N-m	Anzugswert N-m	
	Bolzenzentrierung ng	Mittenzentrierung ng			Bolzenzentrierung ng	Mittenzentrierung ng		
DAF	Sherpa 1,7-2,5; 4 00/500 Turbo Turbo F1100-F95	M 18 x 1,5	90 176 - 203 216 - 270 297 - 351	MITSUBISHI	L 300 2500 Kasten	M 12 x 1,5	120 - 140	
		M 20 x 1,5	290 - 360		L 300 1600 Kasten	M 12 x 1,5	120 - 140	
		M 22 x 1,5	540 - 670		Canter T 35		165 - 225	
		M 22 x 2	378 - 459		Canter T 60		400 - 540	
		F45	M 18 x 1,5		340 - 400	Canter T 75		370 - 410
		F45	M 20 x 1,5		450 - 520	NEOPLAN	M 22 x 1,5	450
FAUN		M 20 x 1,5	450 - 520		M 20 x 1,5	360	450 - 480	
		M 22 x 1,5	700 ± 21	OPEL	7/16"	70		
		M 22 x 1,5	700 ± 21		18 mm	300		
		F85CF, F95CF	M 22 x 1,5	700 ± 21	7/8"	380		
FIAT		M 18 x 1,5	290 - 320	PEUGEOT	alle Modelle	180		
	Transporter	M 20 x 1,5	370 - 400	RVI/RENAULT	S 100; S 110; S 130	320		
		M 22 x 1,5	430 - 460		S 150	400		
FORD		M 20 x 1,5	450 - 520		S 170	500		
		M 22 x 1,5	700 ± 21		Master	160		
		7/8" BSF	575 (SMMT-Rad)			500 ± 50		
	M 22 x 1,5	575 ohne R.-Hinterachsen						
	M 22 x 1,5	575 mit R.-Hinterachsen, 10 Bolzen						
		465 mit R.-Hinterachsen, 8 Bolzen						
		380 mit R.-Hinterachsen, 6 Bolzen						
IVECO	6 5-75E, Euro Cargo 8 0-100E, 120-130E Euro-Tech, -Star, - Trakker	M 18 x 1,5	335 - 410	TATRA		480 ± 80		
		M 20 x 1,5	440 - 540	UNIMOGE	407 V 600	290	27	
		M 22 x 1,5	565 - 690		417 V 900, 1150; 1250; 227 V 1200	320		
KÄSSBOHRER/ SET RA		M 18 x 1,5	300	427 V 1400, 1600	600			
		M 20 x 1,5	400	2100, 437 V 1700				
		M 22 x 1,5	600	VOLVO	FL 6	M 18 x 1,5	375 ± 65	
MAN		M 18 x 1,5	370 - 410	FL 6	M 20 x 1,5	525 ± 75		
		M 20 x 1,5	450 - 500	übrige Modelle	M 22 x 1,5	670 ± 30		
		M 22 x 1,5	550 - 600	7/8" - 14 UNF	670 ± 30			
MAZDA	E2000, 2200 B2500	M 12 x 1,25	90 - 120	VW	LT 1997, Van Typ 2	M 14 x 1,5	180	
		M 12 x 1,25	120 - 150		LT 28, 31	M 14 x 1,5	200	
					LT 35 40 45 50	M 18 x 1,5	360	
MERCEDES		M 14 x 1,5	170	Caddy, Pick up		110		
		M 18 x 1,5	250	ANHÄNGER	M 14 x 1,5	110 - 120		
		M 20 x 1,5	300		M 18 x 1,5	270	320	
		M 22 x 1,5	450		M 20 x 1,5	350	450	
					M 22 x 1,5	450 - 500	600 - 650	

Angaben ohne Gewähr.

Anzugsmomente für Radmuttern und Radschrauben von Personenkraftwagen und Kombi

PKW (Alu-Felgen Herstellerangaben beachten!)

Fahrzeughersteller		Anzugsmoment N·m	Fahrzeughersteller		Anzugsmoment N·m	Fahrzeughersteller		Anzugsmoment N·m	
ALFA ROMEO	Alfa 33	88-108	ISUZU	Trooper (bis 92)	80-118	OPEL	Agila	85	
	Alfa 145/146/147/Spider/GTV	83-103		Trooper (ab 92)	118		Frontera-B (1999-02)	120	
	Alfa 155 (V6)	73-90		Campo (bis 97)	78-98	übrige Modelle	110		
	Alfa 156	98	JAGUAR	X-Type (2001-02)	68-92	PEUGEOT	106/206/Estate	85	
	Alfa 164	95-105		S-Type	128		306	80	
Alfa 166	86	XJ6		65-85	307/406/605/607		90		
		XJR/XJ12	88-102	806/Expert	100				
AUDI	A2/A3/S3/A4/A6/100/A8/S8/TT	120	XJ8/XJ-S	66-82	Boxer	160-180			
	Audi 80/Coupé/Cabriolet/Audi 200 Audi Quattro	110							
BMW	3 Serie/5 Serie	90-110	KIA	Pride/Mentor/Sephia/Clarus/Carens	88-118	PORSCHE	alle Modelle	130	
	M5	100		Sedona/Sportage	88-108		RENAULT	Twingo/Clio/Megane/Safrane/Kangoo R5	90
	Z3	100-110		Besta	90-120			Clio Sport/Scenic RX4	80
X5	140			Laguna/Espace	105				
CHRYSLER	Neon (1994-99)/Stratus/Neon (1999-02)/PT Cruiser	109-150	LADA	Samara/Riva	70-78	Traffic (2000-02)	142		
	Voyager (1987-90)/Caravan	115-155	Niva	88-91	Master	155			
	Voyager (2001-02)	129	LANCIA	übrige Modelle	86	ROVER	Mini Cooper	57	
	Jeep Wrangler (1993-96)	110-135		Defra/Kappa	98		25/45/MG	110	
	Jeep Wrangler (1996-02)	102		LAND ROVER	Freelander		115	75 Tourer/MG ZT-T	125
	Jeep Cherokee (1997-01)	109-150	Defender		100-120	SAAB	900 (1993-98)	90-110	
	Jeep Grand Cherokee (1997-01)	115-150	Discovery (bis 98)		129		9000 (1989-97)	105-125	
		Discovery (ab 98)	140	9-3	110				
		Range Rover (ab 94)	108	9-5	120				
CITROËN	AX10/AX11/AX14/AX GT/AX GTI/AX Sport/ZK	90	LEXUS	alle Modelle	103	SEAT	Arosa/Inca	110	
	Saxo/Xsara	85	LOTUS	Elise (Leichtmetallfelgen)	90		Ibiza/Cordobar	110	
	Xantia/XM	90		Elan (Leichtmetallfelgen)	80-88		Toledo (1999-02)/Leon	120	
	C5	80-100		Excel (Leichtmetallfelgen)	88	Alhambra	140		
	C15E	70		Esprit (Leichtmetallfelgen)	100	SKODA	Fabia/Octavia	120	
	Berlingo	85	MAZDA	121 (ab 1995)	85		SUBARU	alle Modelle	78-98
Dispatch	100	323 (ab 1998)		90-117	SUZUKI	Alto		70-100	
C25	180	626 (ab 1997)		80-115		Swift	80-80		
		Xedos 6 (ab 1994)/MX-6 (ab 1994)/MVP (ab 1999)		89-117		Liana/Ignis/Baleono/Wagon			
		Xedos 9		88-127	R/Super Carry (1999-02)	85			
		MX-5 (ab 1998)	90-117	Jimmy/Grank Vitara	95				
DAEWOO	Matiz	90-110	Tribute	133	Vitara	80-100			
	Nexia/Lanos/Espero/Nubira	80	E-Series	90-120	TOYOTA	Yaris, Corolla, Carina, Avensis, Camry, MR2, Paseo, Celica, Supra, Picnic, Previa, RAV4, 4 Runner	103		
	Leganza	100	MERCEDES-BENZ	übrige Modelle		110	Landcruiser Colorado/Prado (1996-02)	110	
	Tacuma	108		S-Class (1998-02)/M-Class		150	Landcruiser Amazon (1998-02)	209	
	Musso/Korando/	80-120		CL (1999-02)		150	Hi-Ace Power Van (199602)	102	
Cuore/Applause/YRV/Move/Grand Move/Terios	88-118	V-Class (199502)/Vito		175	Volkswagen	Lupo, Caddy, Golf, Polo	110		
Charade/Sirion/Hi-Jet	89-118	200GE/230GE		190		Passat (1996-02), Beetle	120		
Sportrak	90-120	Sprinter (1995-02)	180 + 20	Sharan (2001-02)		170			
FIAT	übrige Modelle	86	MB 100D	140	Transporter (1996-02), LT (1996-02)	180			
	Stilo/Croma/Coupé/	98	508D/510	160-180	VOLVO	S40/V40 (199802), S70/V70 (199700), C70	110		
	Ukysee/Scudo	100	814 DA	250		S60 (200202), V70 (200002), S80	140		
	Ducato/Talento	160	MINI	Mini One/Mini Cooper		90-110	10 N·m ± 1 kp·m	Angaben ohne Gewähr.	
	Ducato Maxi	180		MITSUBISHI		Colt/Lancer (1996-02)/Galant (1997-02)			98
FORD	KA/Mondeo (199600)/Scorpio/Puma	85				Carisma			98-117
	Fiesta (199093)	70-100	Eclipse (1996-02)		117-137				
	Fiesta (1994-02)/Focus (1998-02)	85	3000 GT (1993-01)/L200		120-140				
	Escort/Estate (1995-00)/Sierra	100	Space Star	98-117					
	Probe	88-117	Space Runner (1998-02)	98					
Cougar	128	Space Wagon (1998-02)	98						
Galaxy (2001-02)	170	Shogun Pinin	98						
Maverick (2001-02)	133	Shogun Pajero	100-120						
Explorer	135	NISSAN	Micra (1992-02)/X-Trail	98-117					
Transit 80/100 (1991-00)	75-95		Almera (2002-02)/Maxima (2000-02)/Serena (1996-02)	98-118					
Transit 130 (außer 1995)/150	155-180 (175)		Terrano II/Patrol GR/Pick-Up	118-147					
Transit (2002-02)	200								
HONDA	alle Modelle	108-110							
HYUNDAI	übrige Modelle	90-110							
	Pony (bis 90)/Stellar/	70-80							
	S Coupé (90-92)	88-108							
H1/H200	120-140								

Drehmoment-Umrechnungstabellen

Gegebene Maßeinheit	Drehmoment-Umrechnungsfaktoren			Gewünschte Maßeinheit					
	= mN·m	= cN·m	= N·m	= ozf·in	= lbf·in	= lbf·ft	= gf·cm	= kgf·cm (kp·cm)	= kgf·m (kp·m)
1 mN·m	1	0,1	0,001	0,142	0,009	0,0007	10,2	0,01	0,0001
1 cN·m	10	1	0,01	1,416	0,088	0,007	102	0,102	0,001
1 N·m	1000	100	1	141,6	8,851	0,738	10197	10,2	0,102
1 ozf·in	7,062	0,706	0,007	1	0,0625	0,005	72	0,072	0,0007
1 lbf·in	113	11,3	0,113	16	1	0,083	1152,1	1,152	0,0115
1 lbf·ft	1356	<u>135,6</u>	1,356	192	12	1	13826	13,83	0,138
1 gf·cm	0,098	0,01	0,0001	0,014	0,0009	0,00007	1	0,001	0,00001
1 kgf·cm (kp·cm)	98,07	9,807	0,098	13,89	0,868	0,072	1000	1	0,01
1 kgf·m (kp·m)	9807	980,7	9,807	1389	86,8	7,233	100000	100	1

Anwendung

Umrechnungs-Formel:
gegebene Maßeinheit
x Faktor
= gewünschte
Maßeinheit

Beispiel:
Umrechnung von
5 lbf·ft in cN·m

Lösung:
5 x 135,6 = 678 cN·m

Umrechnung von N·m in kgf·m (kp·m)

N·m	0	1	2	3	4	5	6	7	8	9
0	0,00	0,10	0,20	0,31	0,41	0,51	0,61	0,71	0,82	0,92
10	1,02	1,12	1,22	1,33	1,43	1,53	1,63	1,73	1,84	1,94
20	2,04	2,14	2,24	2,35	2,45	2,55	2,65	2,75	2,86	2,96
30	3,06	3,16	3,26	3,37	3,47	3,57	3,67	3,77	3,87	3,98
40	4,08	4,18	4,28	4,38	4,49	4,59	4,69	4,79	4,89	5,00
50	5,10	5,20	5,30	5,40	5,51	5,61	5,71	5,81	5,91	6,02
60	6,12	6,22	6,32	6,42	6,53	6,63	6,73	6,83	6,93	7,04
70	7,14	7,24	7,34	7,44	7,55	7,65	7,75	7,85	7,95	8,06
80	8,16	8,26	8,36	8,46	8,57	8,67	8,77	8,87	8,97	9,08
90	9,18	9,28	9,38	9,48	9,59	9,69	9,79	9,89	9,99	10,10
100	10,20	10,30	10,40	10,50	10,60	10,71	10,81	10,91	11,01	11,11

Umrechnung von kgf·m (kp·m) in N·m

kgf·m (kp·m)	0	1	2	3	4	5	6	7	8	9
0	0,00	9,81	19,61	29,42	39,23	49,03	58,84	68,65	78,45	88,26
10	98,07	107,87	117,68	127,49	137,29	147,10	156,91	166,71	176,52	186,33
20	196,13	205,94	215,75	225,55	235,36	245,17	254,97	264,78	274,59	284,39
30	294,20	304,01	313,81	323,62	333,43	343,23	353,04	362,85	372,65	382,46
40	392,27	402,07	411,88	421,69	431,49	441,30	451,11	460,91	470,72	480,53
50	490,33	500,14	509,95	519,75	529,56	539,37	549,17	558,98	568,79	578,59
60	588,40	598,21	608,01	617,82	627,63	637,43	647,24	657,05	666,85	676,66
70	686,47	696,27	706,08	715,89	725,69	735,50	745,31	755,11	764,92	774,73
80	784,53	794,34	804,15	813,95	823,76	833,57	843,37	853,18	862,99	872,79
90	882,60	892,41	902,21	912,02	921,83	931,63	941,44	951,25	961,05	970,86
100	980,67	990,47	1000,28	1010,08	1019,89	1029,70	1039,50	1049,31	1059,12	1068,92

Umrechnung von N·m in lbf·ft

N·m	0	1	2	3	4	5	6	7	8	9
0	0,00	0,74	1,48	2,21	2,95	3,69	4,43	5,16	5,90	6,64
10	7,38	8,11	8,85	9,59	10,33	11,06	11,80	12,54	13,28	14,01
20	14,75	15,49	16,23	16,96	17,70	18,44	19,18	19,91	20,65	21,39
30	22,13	22,86	23,60	24,34	25,08	25,81	26,55	27,29	28,03	28,76
40	29,50	30,24	30,98	31,72	32,45	33,19	33,93	34,67	35,40	36,14
50	36,88	37,62	38,35	39,09	39,83	40,57	41,30	42,04	42,77	43,52
60	44,25	44,99	45,73	46,47	47,20	47,94	48,68	49,42	50,15	50,89
70	51,63	52,37	53,10	53,84	54,58	55,32	56,05	56,79	57,53	58,27
80	59,00	59,74	60,48	61,22	61,96	62,69	63,43	64,17	64,91	65,64
90	66,38	67,12	67,86	68,59	69,33	70,07	70,81	71,54	72,28	73,02
100	73,76	74,49	75,23	75,97	76,71	77,44	78,18	78,92	79,66	80,39

Umrechnung von lbf·ft in N·m

lbf·ft	0	1	2	3	4	5	6	7	8	9
0	0,00	1,36	2,71	4,07	5,42	6,78	8,13	9,49	10,85	12,20
10	13,56	14,91	16,27	17,63	18,98	20,34	21,69	23,05	24,40	25,76
20	27,12	28,47	29,83	31,18	32,54	33,90	35,25	36,61	37,96	39,32
30	40,67	42,03	43,39	44,74	46,10	47,45	48,81	50,16	51,52	52,88
40	54,23	55,59	56,94	58,30	59,66	61,01	62,37	63,72	65,08	66,43
50	67,79	69,15	70,50	71,86	73,21	74,57	75,93	77,28	78,64	79,99
60	81,35	82,70	84,06	85,42	86,77	88,13	89,48	90,84	92,20	93,55
70	94,91	96,26	97,62	98,97	100,33	101,69	103,04	104,40	105,75	107,11
80	108,46	109,82	111,18	112,53	113,89	115,24	116,60	117,96	119,31	120,67
90	122,02	123,38	124,73	126,09	127,45	128,80	130,16	131,51	132,87	134,23
100	135,58	136,94	138,29	139,65	141,00	142,36	143,72	145,07	146,43	147,78

Umrechnung von N·m in lbf·in

N·m	0	1	2	3	4	5	6	7	8	9
0	0,00	8,85	17,70	26,55	35,40	44,25	53,10	61,96	70,81	79,66
10	88,51	97,36	106,21	115,06	123,91	132,76	141,61	150,46	159,31	168,16
20	177,02	185,87	194,72	203,57	212,42	221,27	230,12	238,97	247,82	256,67
30	265,52	274,37	283,22	292,08	300,93	309,78	318,63	327,48	336,33	345,18
40	354,03	362,88	371,73	380,58	389,43	398,28	407,14	415,99	424,84	433,69
50	442,54	451,39	460,24	469,09	477,94	486,79	495,64	504,49	513,34	522,20
60	531,05	539,90	548,75	557,60	566,45	575,30	584,15	593,00	601,85	610,70
70	619,55	628,40	637,26	646,11	654,96	663,81	672,66	681,51	690,36	699,21
80	708,06	716,91	725,76	734,61	743,46	752,32	761,17	770,02	778,87	787,72
90	796,57	805,42	814,27	823,12	831,97	840,82	849,67	858,52	867,38	876,23
100	885,08	893,93	902,78	911,63	920,48	929,33	938,18	947,03	955,88	964,73

Umrechnung von lbf·in in N·m

lbf·in	0	1	2	3	4	5	6	7	8	9
0	0,00	0,11	0,23	0,34	0,45	0,56	0,68	0,79	0,90	1,02
10	1,13	1,24	1,36	1,47	1,58	1,69	1,81	1,92	2,03	2,15
20	2,26	2,37	2,49	2,60	2,71	2,82	2,94	3,05	3,16	3,28
30	3,39	3,50	3,62	3,73	3,84	3,95	4,07	4,18	4,29	4,41
40	4,52	4,63	4,75	4,86	4,97	5,08	5,20	5,31	5,42	5,54
50	5,65	5,76	5,87	5,99	6,10	6,21	6,33	6,44	6,55	6,67
60	6,78	6,89	7,00	7,12	7,23	7,34	7,46	7,57	7,68	7,80
70	7,91	8,02	8,13	8,25	8,36	8,47	8,59	8,70	8,81	8,93
80	9,04	9,15	9,26	9,38	9,49	9,60	9,72	9,83	9,94	10,06
90	10,17	10,28	10,39	10,51	10,62	10,73	10,85	10,96	11,07	11,19
100	11,30	11,41	11,52	11,64	11,75	11,86	11,98	12,09	12,20	12,31

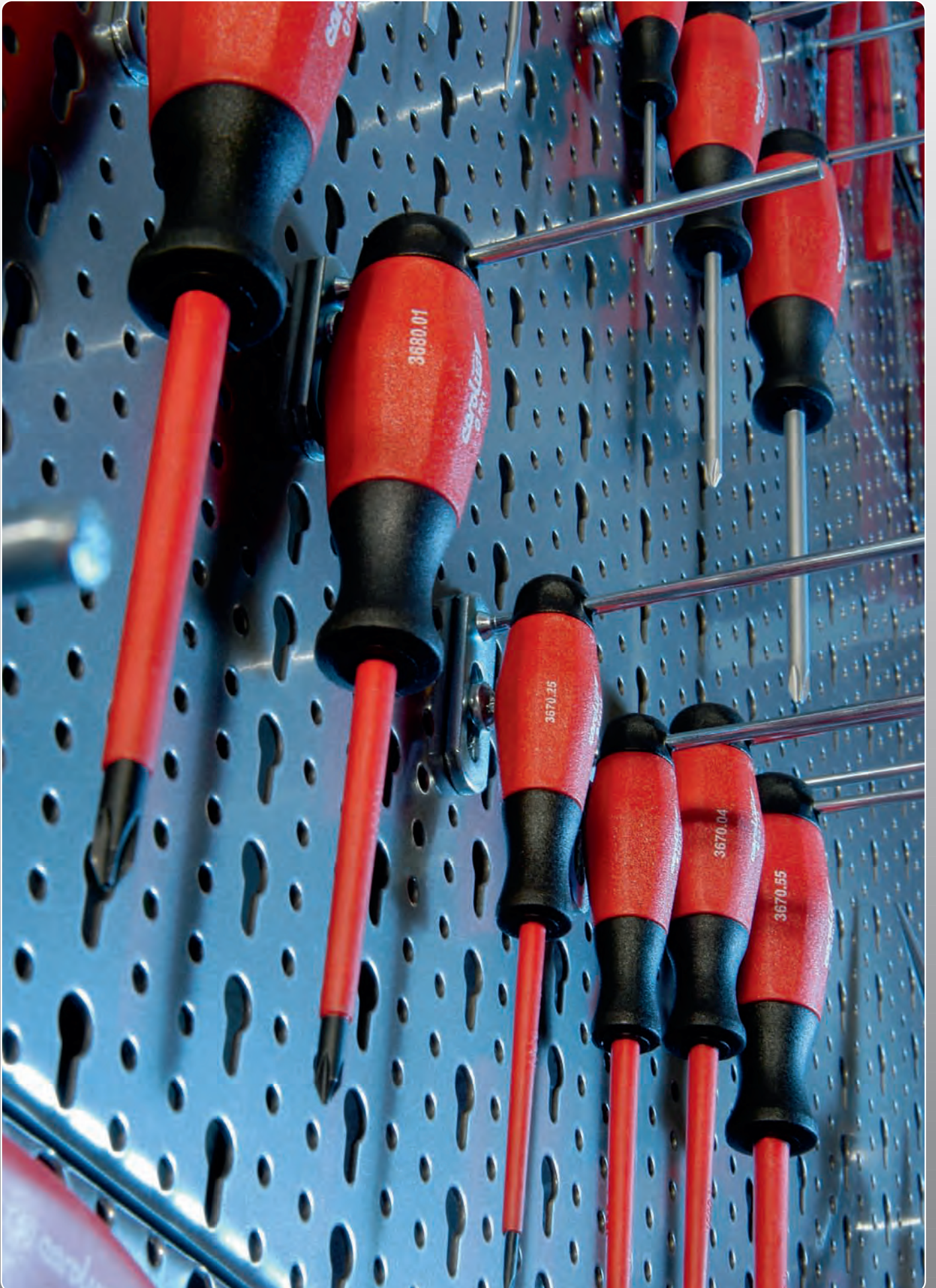

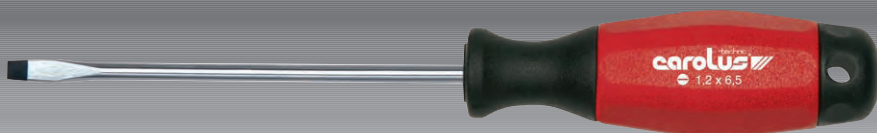

	Code	Art.-No.								
				mm	mm	mm	mm			
	1694820	3600.03	0,5 x 3,0	80	80	160	3,0	10	25	
	1694839	3600.04	0,8 x 4,0	100	90	190	4,0	10	45	
	1694863	3600.55	1,0 x 5,5	125	100	225	5,0	10	69	
	1694871	3600.65	1,2 x 6,5	150	110	260	6,0	10	101	
	1694847	3600.08	1,2 x 8,0	175	120	295	7,0	5	156	
	1694855	3600.10	1,6 x 10,0	200	120	320	8,0	5	189	



	Code	Art.-No.								
				mm	mm	mm	mm			
	1694944	3610.55	1,0 x 5,5	100	100	200	5,0	10	68	
	1694952	3610.65	1,2 x 6,5	125	110	235	6,0	10	95	
	1694928	3610.08	1,2 x 8,0	150	120	270	7,0	5	157	
	1694936	3610.10	1,6 x 10,0	175	120	295	8,0	5	187	



	Code	Art.-No.								
				mm	mm	mm	mm			
	1694960	3620.04	0,8 x 4,0	25	60	85	4,0	10	25	
	1694979	3620.65	1,2 x 6,5	25	60	85	6,5	10	35	



	Code	Art.-No.								
				mm	mm	mm	mm			
	1694987	3630.00	PH 0	60	80	140	3,0	10	25	
	1694995	3630.01	PH 1	80	100	180	4,5	10	55	
	1695002	3630.02	PH 2	100	110	210	6,0	10	90	
	1695010	3630.03	PH 3	150	120	270	8,0	5	177	



	Code	Art.-No.								
				mm	mm	mm	mm			
	1695029	3640.00	PZ 0	60	80	140	3,0	10	25	
	1695037	3640.01	PZ 1	80	100	180	4,5	10	55	
	1695045	3640.02	PZ 2	100	110	210	6,0	10	90	
	1695053	3640.03	PZ 3	150	120	270	8,0	5	177	



+	Code	Art.-No.	+						
				mm	mm	mm	mm		
	1695061	3650.01	PH 1	25	60	85	4,5	10	30
	1695088	3650.02	PH 2	25	60	85	6,0	10	32



*	Code	Art.-No.	+						
				mm	mm	mm	mm		
	1695096	3660.01	PZ 1	25	60	85	4,5	10	25
	1695118	3660.02	PZ 2	25	60	85	6,0	10	32



*	Code	Art.-No.	*						
				mm	mm	mm	mm		
	1695452	3690.06	TX6	60	80	140	3,0	10	24
	1695460	3690.07	TX7	60	80	140	3,0	10	24
	1695479	3690.08	TX8	60	80	140	3,0	10	24
	1695487	3690.09	TX9	60	80	140	3,0	10	24
	1695495	3690.10	TX10	80	80	160	3,0	10	25
	1695509	3690.15	TX15	80	90	170	3,5	10	39
	1695517	3690.20	TX20	100	90	190	4,0	10	45
	1695525	3690.25	TX25	100	100	200	4,5	10	62
	1695533	3690.27	TX27	115	100	215	5,5	10	74
	1695541	3690.30	TX30	115	110	225	6,0	10	93
	1695568	3690.40	TX40	130	120	250	7,0	5	100
	1695576	3690.45	TX45	130	120	250	8,0	5	165



150 - 250 V

-	Code	Art.-No.	-					
				mm				
	1695584	3710.03	3,0	135			10	28

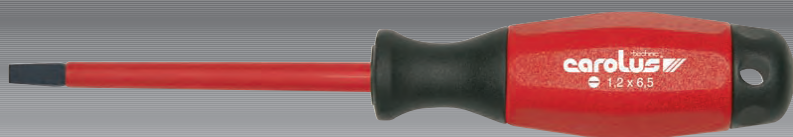

AC 1000 V

	Code	Art.-No.	mm	mm	mm	mm		
	1695398	3670.25	0,4 x 2,5	75	80	155	2,5	10 25
	1695363	3670.03	0,5 x 3,0	100	80	180	3,0	10 27
	1695371	3670.04	0,8 x 4,0	100	90	190	3,5	10 46
	1695401	3670.55	1,0 x 5,5	125	100	225	5,0	10 79



AC 1000 V

	Code	Art.-No.	mm	mm	mm	mm		
	1695428	3680.01	PH 1	80	100	180	4,5	10 46
	1695436	3680.02	PH 2	100	110	210	6,0	10 81



	Code	Art.-No.	mm					
 	1694898	3603.00	3	1	530			
			5,5					
			6,5					
			0					
			1					
			2					



	Code	Art.-No.	mm					
 	1694901	3604.00	3	1	530			
			5,5					
			6,5					
			0					
			1					
			2					



	Code	Art.-No.						
	1695444	3690.00	TX10	1	530			
			TX15					
			TX20					
			TX25					
			TX30					
			TX40					



	Code	Art.-No.						
					mm	mm	mm	
	1797913	3695.00		TX5	40	98,4	138,4	654
			TX6	40,2	98,4	138,6		
			TX7	40,2	98,6	138,8		
			TX8	40,4	98,6	139		
				1,2	40,2	98,4	138,6	
				1,5	40	98,4	138,4	
				PH00	40	98,4	138,4	
				PH000	40	98,4	138,4	



	Code	Art.-No.						
					mm	mm	mm	
	1851934	3695.05		TX5	40	98,4	138,4	10
	1851942	3695.06		TX6	40,2	98,4	138,6	10
	1851950	3695.07		TX7	40,2	98,6	138,8	10
	1851969	3695.08		TX8	40,4	98,6	139	10
	1851888	3605.12		1,2	40,2	98,4	138,6	10
	1851896	3605.15		1,5	40	98,4	138,4	10
	1851918	3635.00		PH00	40	98,4	138,4	10
	1851926	3636.00		PH000	40	98,4	138,4	10



Code	Art.-No.						
1851764	2055.13						75



Code	Art.-No.						
1851748	2045.11						65



Code	Art.-No.						
1851853	2090.13						15



-









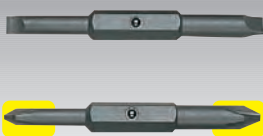



+

Code	Art.-No.						
1797921	3600.00						85















Maximus®





	Code 1513885	Art.-No. 4003.86	 5,5  6,5  PH1  PH2  PZ1  PZ2	 mm 100	 mm 100	 mm 200	 mm 10,6	 12	 146
---	-----------------	----------------------------	--	---	--	---	--	--	---













Maximus®





	Code 1699407	Art.-No. 4003.86A	 5,5  6,5  PH1  PH2	 mm 100	 mm 100	 mm 200	 mm 10,6	 12	 146
---	-----------------	-----------------------------	--	---	--	---	--	--	---













Maximus®





	Code 1699415	Art.-No. 4003.93	 5,5  6,5  PZ1  PZ2	 mm 100	 mm 100	 mm 200	 mm 10,6	 12	 146
---	-----------------	----------------------------	--	---	--	---	--	--	---













Maximus®



	Code 1513990	Art.-No. 4003.96	 PH1  PH2  PZ1  PZ2	 mm 100	 mm 100	 mm 200	 mm 10,6	 12	 146
---	-----------------	----------------------------	--	---	--	---	--	--	---

Maximus®



	Code 1513966	Art.-No. 4003.95	 3  4  5  6	 mm 100	 mm 100	 mm 200	 mm 10,6	 12	 146
---	-----------------	----------------------------	--	---	--	---	--	--	---

6



Maximus®

★	Code	Art.-No.	● TX10 ● TX15 ● TX20 ● TX25	mm	mm	mm	mm	12	146
	1513958	4003.94							

Maximus®

★	Code	Art.-No.	● TX20 ● TX25 ● TX27 ● TX30	mm	mm	mm	mm	12	146
	1513974	4003.97							

Maximus®

+	Code	Art.-No.	⊕ PH 1 / 2 ⊕ PZ 1 / 2 ⊕ PH / PZ 1 / 2 ⊖ 5,5 / 6,5 ● TX10 / TX15 ● TX20 / TX25 ● TX27 / TX30 ● 3 / 4 ● 5 / 6	mm	1	22
	1516019	4386.01			75	1
1516027	4386.02		75	1	22	
1645307	4386.03		75	1	22	
1516035	4386.05		75	1	22	
1516051	4386.10		75	1	22	
1516078	4386.20		75	1	22	
1516086	4386.27		75	1	22	
1516094	4386.30		75	1	22	
1516108	4386.50		75	1	22	

Maximus®





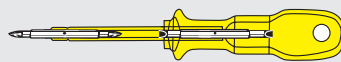



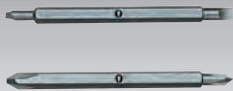



+	Code	Art.-No.	⊕ PH1 / 2 ⊕ PZ1 / 2 ⊖ 5,5 / 6,5 ● TX10 / TX15 ● TX20 / TX25 ● TX27 / TX30 ● SW3 / 4 ● SW5 / 6	1	790
	1514652	4100.00			

1/4" ■ x 8mm ●

















Minimus®



 	Code 1513842	Art.-No. 4002.43	 2,5  3,5  PH0  PH1	 mm 90	 mm 90	 mm 180	 mm 6,3	 12	 72
--	-----------------	----------------------------	--	--	---	---	---	---	---









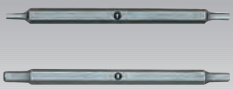



Minimus®



  	Code 1513877	Art.-No. 4002.46	 PH0  PH1  PZ0  PZ1	 mm 90	 mm 90	 mm 180	 mm 6,3	 12	 72
---	-----------------	----------------------------	--	--	---	---	---	---	---









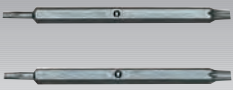



Minimus®



	Code 1513869	Art.-No. 4002.45	 1,5  2,0  2,5  3,0	 mm 90	 mm 90	 mm 180	 mm 6,3	 12	 72
---	-----------------	----------------------------	--	--	---	---	---	---	---

Minimus®



	Code 1513850	Art.-No. 4002.44	 TX7  TX10  TX8  TX15	 mm 90	 mm 90	 mm 180	 mm 6,3	 12	 72
---	-----------------	----------------------------	--	--	---	---	---	---	---

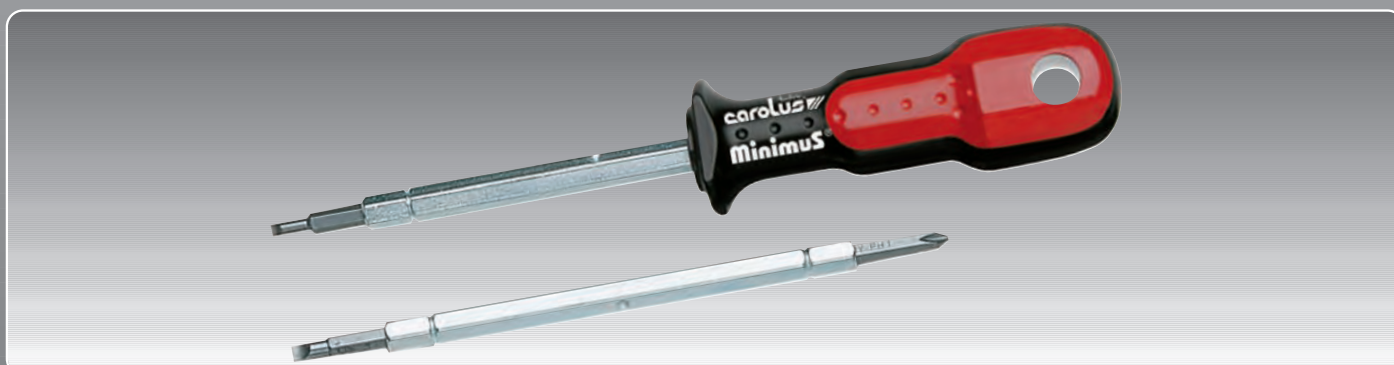

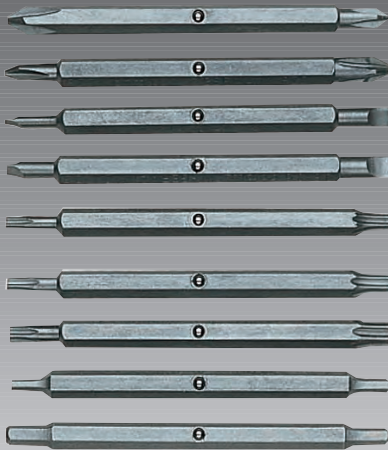
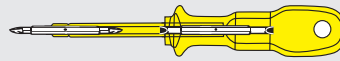

Minimus®

	Code	Art.-No.		← mm	📦	⚖️
⊕	1515918	4244.00	⊕ PH 0 / 1	60	1	6
⊕	1515926	4244.01	⊕ PZ 0 / 1	60	1	6
⊕	1515977	4244.18	⊕ 1,8 / 3,0	60	1	6
⊕	1515985	4244.25	⊕ 2,5 / 3,5	60	1	6
⊕	1515934	4244.07	⊕ TX7 / TX10	60	1	6
⊕	1515942	4244.08	⊕ TX8 / TX15	60	1	6
⊕	1515950	4244.09	⊕ TX9 / TX20	60	1	6
⊕	1515969	4244.15	⊕ 1,5 / 2,0	60	1	6
⊕	1516000	4244.30	⊕ 2,5 / 3,0	60	1	6



Minimus®

	Code	Art.-No.		📦	⚖️
⊕	1515896	4200.00	⊕ PH0 / 1	1	590
⊕			⊕ PZ0 / 1		
⊕			⊕ 1,8 / 3,0		
⊕			⊕ 2,5 / 3,5		
⊕			⊕ TX7 / TX10		
⊕			⊕ TX8 / TX15		
⊕			⊕ TX9 / TX20		
⊕			⊕ SW1,5 / 2,0		
⊕			⊕ SW2,5 / 3,0		

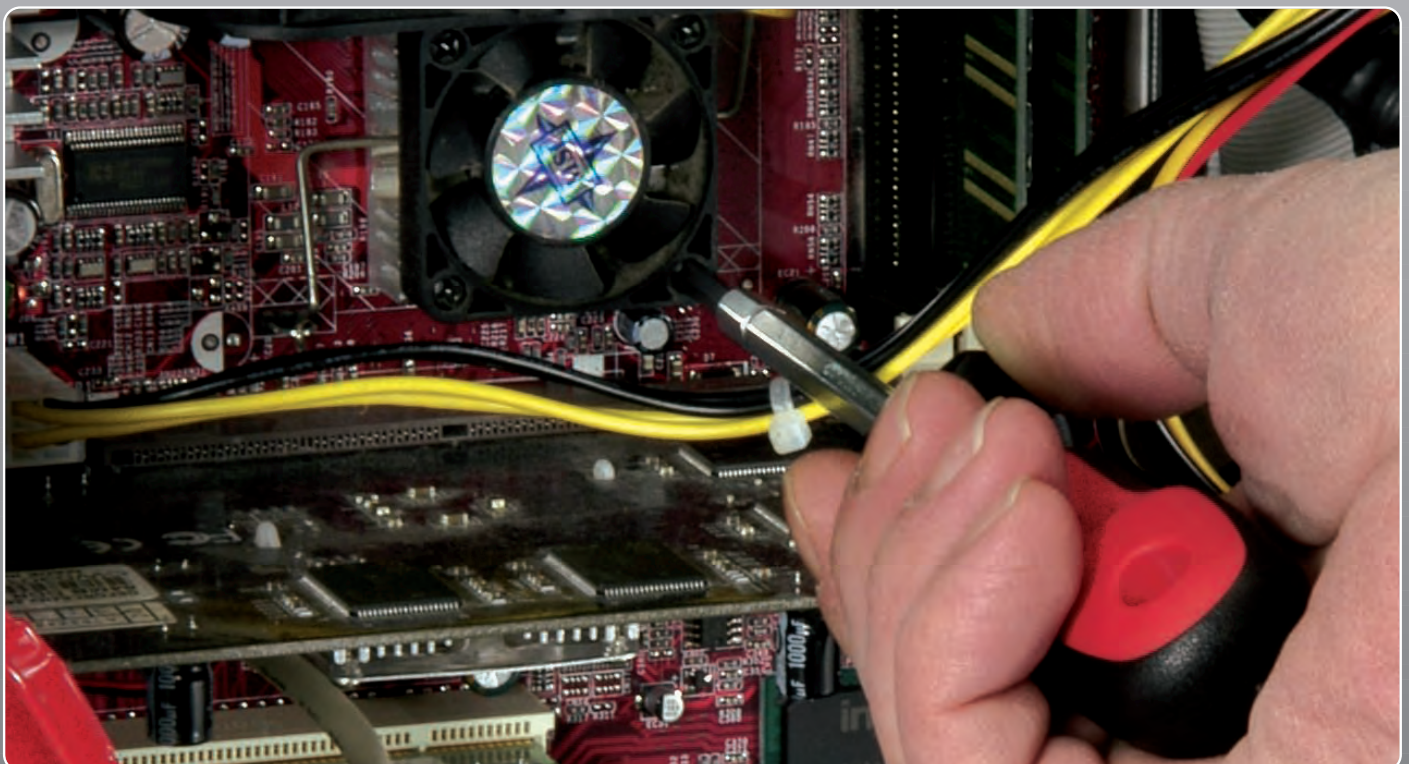







170 - 360 mm





1/4"

- 5 - 6 - 8 - 9 - 10
- E5 - E6 - E7 - E8 - E10
- TX10 - TX15 - TX20 - TX25 - TX27 - TX30
- 4,5 - 5,5 - 6,0 - 6,5 - 8,0mm

- PH1 - PH2 - PH3
- PZ1 - PZ2 - PZ3
- 3 - 4 - 5 - 6 - 8
- 1/4" x 1/4"
- 1/4" □

Code	Art.-No.					
1819984	4003.80					850









170 - 360 mm



Code	Art.-No.	mm	mm	mm		
1819976	4003.87	170 - 360	122	482		225

Code	Art.-No.	mm	mm	mm		
1672088	3810.25	2,5	112	152	10	40
1672096	3810.03	3,0	125	165	10	45
1672142	3810.04	4,0	142	182	10	55
1672169	3810.05	5,0	160	200	10	70
1672177	3810.06	6,0	180	220	10	90
1672185	3810.08	8,0	200	240	5	150
1672215	3810.10	10,0	224	264	5	230









Code	Art.-No.	mm	mm	mm		
1672088	3810.25	2,5	112	152	10	40
1672096	3810.03	3,0	125	165	10	45
1672142	3810.04	4,0	142	182	10	55
1672169	3810.05	5,0	160	200	10	70
1672177	3810.06	6,0	180	220	10	90
1672185	3810.08	8,0	200	240	5	150
1672215	3810.10	10,0	224	264	5	230

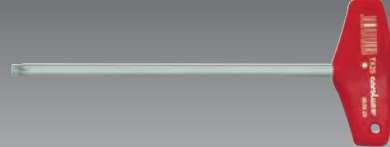







Code	Art.-No.	mm	mm	mm		
1672258	3820.08	TX8	90	130	10	44
1672274	3820.09	TX9	105	145	10	49
1672282	3820.10	TX10	105	145	10	49
1672312	3820.15	TX15	125	165	10	51
1672320	3820.20	TX20	140	180	10	53
1672347	3820.25	TX25	145	185	10	57
1672371	3820.27	TX27	160	200	10	73
1672401	3820.30	TX30	160	200	10	77
1672444	3820.40	TX40	185	225	5	98



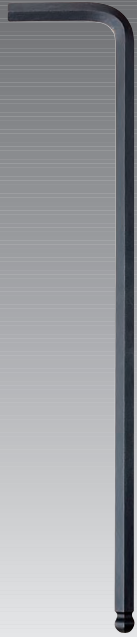

Code	Art.-No.		mm					
1671359	3720.02	●	2,0	16	x	50		10 2
1671391	3720.25	●	2,5	18	x	56		10 3
1671448	3720.03	●	3,0	20	x	63		10 5
1671685	3720.04	●	4,0	25	x	70		10 10
1671693	3720.05	●	5,0	28	x	80		10 18
1671707	3720.06	●	6,0	32	x	90		10 29
1671715	3720.07	●	7,0	34	x	95		10 42
1671723	3720.08	●	8,0	36	x	100		10 58
1670832	3720.10	●	10,0	40	x	105		10 100
1695614	3730.02	⚙	2,0	16	x	100		10 3
1695703	3730.25	⚙	2,5	18	x	112		10 5
1695630	3730.03	⚙	3,0	20	x	126		10 8
1695649	3730.04	⚙	4,0	25	x	140		10 20
1695657	3730.05	⚙	5,0	28	x	160		10 30
1695665	3730.06	⚙	6,0	32	x	180		10 50
1695673	3730.08	⚙	8,0	36	x	200		10 100
1695681	3730.10	⚙	10,0	40	x	224		10 180
1695746	3740.07	★	TX7	16	x	48		10 3
1695770	3740.08	★	TX8	16	x	48		10 3
1695797	3740.09	★	TX9	16	x	48		10 3
1695819	3740.10	★	TX10	17	x	51		10 3
1695827	3740.15	★	TX15	18	x	54		10 5
1695835	3740.20	★	TX20	19	x	57		10 7
1695843	3740.25	★	TX25	20	x	60		10 10
1695851	3740.27	★	TX27	21	x	64		10 15
1695886	3740.30	★	TX30	24	x	70		10 20
1695894	3740.40	★	TX40	26	x	76		10 30



Code	Art.-No.							
1671324	3720.00	●	2					1 225
		●	2,5					
		●	3					
		●	4					
		●	5					
		●	6					
		●	8					
		●	10					

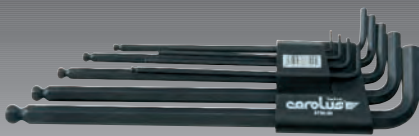

Code	Art.-No.							
1695592	3730.00	⚙	1,5					1 429
		⚙	2					
		⚙	2,5					
		⚙	3					
		⚙	4					
		⚙	5					
		⚙	6					
		⚙	8					
		⚙	10					



Code	Art.-No.							
1695711	3740.00	★	TX10					1 120
		★	TX15					
		★	TX20					
		★	TX25					
		★	TX27					
		★	TX30					
		★	TX40					

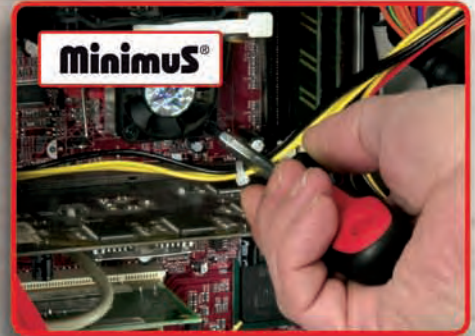

carolus 







Code	Art.-No.			mm		
1853767	2030.18N			180	10	250
1853759	2030.20N			200	10	350



Code	Art.-No.			mm		
1824783	2040.16N			160	10	210
1853740	2040.20N			200	10	305



Code	Art.-No.			mm		
1853732	2050.16N			160	10	140
1853724	2050.20N			200	10	200
1851756	2050.30			200	10	210



1000 V
geprüft EN 60900

Code	Art.-No.			mm		
1820397	2041.16			160	10	190

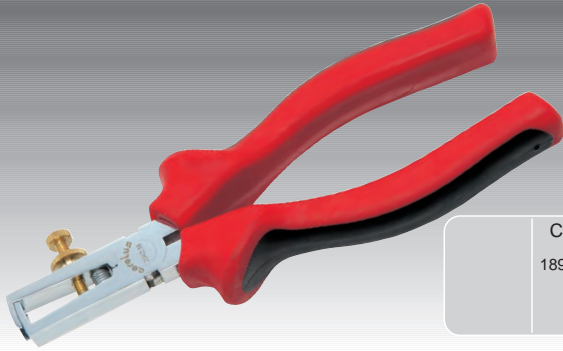

Code 1890018	Art.-No. 2042.16		mm 170	1	190
-----------------	----------------------------	--	-----------	---	-----



Code 1890344	Art.-No. 2060.18	● mm 19 - 60	mm 180	1	175
-----------------	----------------------------	-----------------	-----------	---	-----



Code 1890352	Art.-No. 2061.17	● mm 19 - 60	mm 170	1	180
-----------------	----------------------------	-----------------	-----------	---	-----

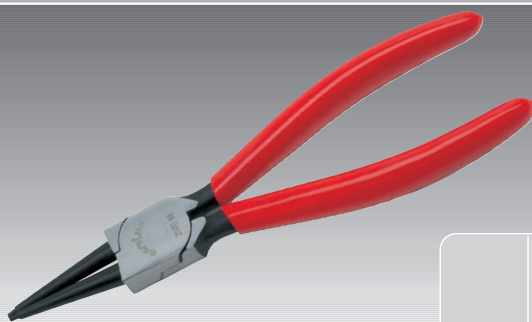

Code 1890360	Art.-No. 2070.18	○ mm 19 - 60	mm 180	1	175
-----------------	----------------------------	-----------------	-----------	---	-----



Code 1890379	Art.-No. 2071.17	○ mm 19 - 60	mm 170	1	165
-----------------	----------------------------	-----------------	-----------	---	-----



Code	Art.-No.			mm		
1919482	2010.07	7"		170	10	170
1680854	2010.10	10"		245	10	230
1919490	2010.12	12"		300	10	480



Code	Art.-No.			mm		
1680846	2020.07	7"		180	10	280
1680838	2020.10	10"		230	10	500

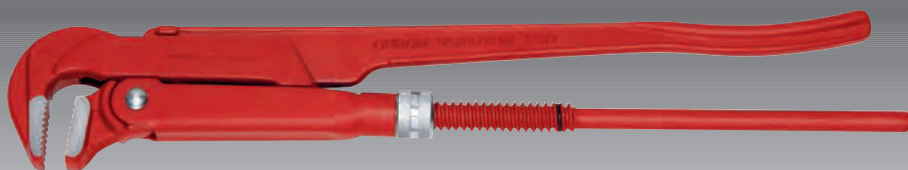

Code	Art.-No.			mm		
1892118	2175.10	1"		320	1	780
1892126	2175.15	1.1/2"		420	1	1290
1892134	2175.20	2"		555	1	2320
1892142	2175.30	3"		630	1	3150



Code	Art.-No.			mm		
1892150	2176.05	1/2"		230	1	400
1892169	2176.10	1"		320	1	780
1892177	2176.15	1.1/2"		415	1	1370
1892185	2176.20	2"		535	1	2330
1892193	2176.30	3"		665	1	4370



Code	Art.-No.			mm		
1892207	2179.05	1/2"		230	1	400
1892215	2179.10	1"		325	1	840
1892223	2179.15	1.1/2"		420	1	1390
1892231	2179.20	2"		535	1	2450
1892258	2179.30	3"		640	1	4260





Code	Art.-No.	g	mm	mm	kg
1696661	9200.10	100	260	10	150
1696688	9200.20	200	280	10	255
1696696	9200.30	300	300	10	420
1696718	9200.50	500	320	10	610
1696726	9200.80	800	350	10	970
1696653	9200.00	1000	360	10	1235



Code	Art.-No.	g	mm	kg	
1696734	9250.00	1000	260	10	1235



Code	Art.-No.	g	mm	kg	
1696742	9260.50	5000	800	1	5925



Code	Art.-No.	Ø mm	mm	mm	kg	
1696769	9280.22	22		250	10	160
1696777	9280.32	32		280	10	360
1696785	9280.40	40		320	10	620
1696793	9281.22	22		2	2	30
1696807	9281.32	32		2	80	
1696815	9281.40	40		2	130	



Code	Art.-No.	Ø mm	mm	mm	kg	
1696750	9270.02	65	115	340	10	540

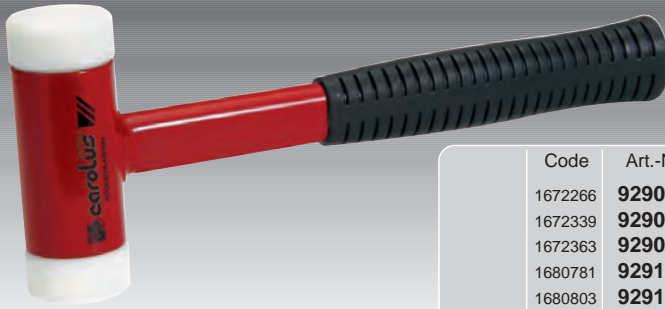

Code	Art.-No.	Ø mm		mm		
1672266	9290.30	30		290	1	585
1672339	9290.40	40		300	1	820
1672363	9290.50	50		310	1	1180
1680781	9291.30	30			2	18
1680803	9291.40	40			2	35
1680811	9291.50	50			2	58



Code	Art.-No.	mm		
1824910	9000.00	0 - 150	1	290



Ø 3 · 4 · 5 · 6 · 7 · 8 mm

Code	Art.-No.		
1696823	9410.00	1	800



Ø 1 · 2 · 3 · 4 · 5 · 10 mm

Code	Art.-No.		
1696831	9420.00	1	720



125 · 150 mm
 125 mm
 Ø 3 mm
 Ø 4 mm
 Ø 4 mm

Code	Art.-No.		
1696858	9430.00	1	820



10mm

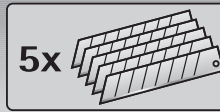

Code	Art.-No.								
1855018	9111.00							12	70



Code	Art.-No.							1	30
1855026	9111.11								



18mm

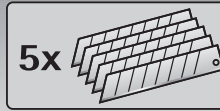

Code	Art.-No.							12	150
1825038	9110.00								

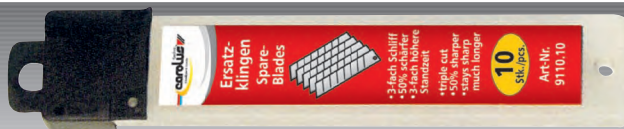

Code	Art.-No.							1	90
1825046	9110.10								



25mm

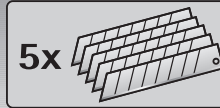

Code	Art.-No.							10	280
1880071	9112.00								

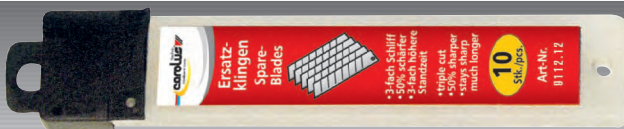

Code	Art.-No.							1	170
1880098	9112.12								





Einsteiger-Modell

4 Schubladen je 75 mm hoch

Gewicht: 42 kg

Gesamtzuladung: 180 kg

Masse: H 930 x B 630 x T 410 mm

Farbe: RAL 3002

großer verschließbarer Stauraum
mit Frontklappe,

Max. Beladung: je Lade 20 kg

gekröpfter Fahrgriff

Schublade: 482 x 345 mm

Starter model

4 drawers each 75mm high

Weight: 42 kg

Total loading capacity: 180 kg

Measurements: H 930 x L 630 x W 410 mm

Colour: RAL 3002

Large lockable storage area with
front shutter,

Max. loading: 20 kg each drawer

Cranked handle

Drawer: 482 x 345 mm

Code	Art.-No.		🚚
1928767	2020.14	ohne Inhalt / without contents	42000



- 4 - 4,5 - 5 - 5,5 - 6 - 7 - 8 - 9 - 10 - 11 - 12 - 13 - 14
- 4 - 4,5 - 5 - 5,5 - 6 - 7 - 8 - 9 - 10 - 11 - 12 - 13
- 3/16" - 7/32" - 1/4" - 9/32" - 5/16" - 11/32" - 3/8" - 13/32" - 7/16" - 1/2"
- 1/4" - 5/16"
- TX10 - TX15 - TX20 - TX25 - TX27 - TX30 - TX40
- E5 - E6 - E7 - E8 - E10
- 3 - 4 - 5 - 6 - 8 - 10 mm
- 1/8" - 5/32" - 3/16" - 1/4" - 5/16" - 7/32"
- 4 - 5,5 - 6,5 mm
- 1/4" □ 1/4" □
- 1/4" ● x 1/4" ■
- 1/4" ○ x 1/4" ○
- 1/4" □ x 1/4" ■
- 1,5 - 2 - 2,5 - 3 - 4 - 5 - 6 - 8 - 10
- 1/4"
- readyflex
- 50 / 100 mm

Code	Art.-No.	mm	Teile / pcs.	
1893653	2020.031	480 x 340	92	2310



- 1/2"
- 10 - 11 - 12 - 13 - 14 - 15 - 16 - 17 - 18 - 19 - 20 - 21 - 22 - 23 - 24 - 26 - 27 - 28 - 30 - 32 mm
- 125 / 250 mm

Code	Art.-No.	mm	Teile / pcs.	
1893661	2020.032	480 x 340	25	3640



- 6x7 - 8x9 - 10x11 - 12x13 - 14x15 - 16x17 - 18x19 - 20x22 - 21x23 - 24x27 - 25x28 - 30x32
- 6x7 - 8x9 - 10x11 - 12x13 - 14x15 - 16x17 - 18x19 - 20x22 - 21x23 - 24x27 - 25x28 - 30x32

Code	Art.-No.	mm	Teile / pcs.	
1893688	2020.033	480 x 340	24	5990

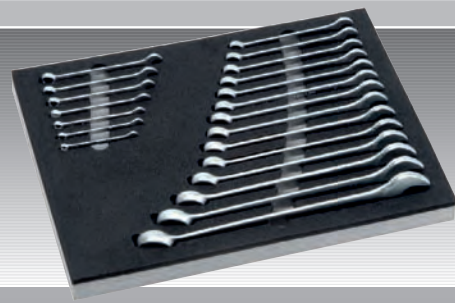

- 6 - 7 - 8 - 9 - 10 - 11 - 12 - 13 - 14 - 15 - 16 - 17 - 18 - 19 - 20 - 21 - 22 - 24 - 27 - 30 - 32

Code	Art.-No.	mm	Teile / pcs.	
1893726	2020.036	480 x 340	21	3490



- 3/8"
- 8 - 10 - 11 - 12 - 13 - 14 - 15 - 16 - 17 - 18 - 19 mm
- E4 - E5 - E6 - E7 - E8 - E10 - E12 - E14 - E16
- 16 - 21 mm
- 5/16"
- TX20 - TX25 - TX27 - TX30 - TX40 - TX45 - TX50 - TX55 - TX60
- TX20 - TX25 - TX27 - TX30 - TX40 - TX45 - TX50 - TX55 - TX60
- 50 mm
- 4 - 5 - 6 - 7 - 8 - 10 - 12 - 14 mm
- 3/8"
- 45 / 150 mm
- 5 - 6 - 8 - 10 - 12 mm
- 5/16"
- 5/16" ● x 3/8" ■
- 4 - 5 - 6 - 7 - 8 - 10 mm
- 5/16" ● x 5/16" ○
- 100 mm
- TX40 - TX45
- 3/8" □ x 5/16" ○
- 4 - 5 - 6 - 7 - 8 - 10 mm
- 1/2" □ x 5/16" ○
- 8 - 10 - 12 mm
- 1/2" ■ x 5/16" ●

Code	Art.-No.	mm	Teile / pcs.	
1893696	2020.034	480 x 340	78	3110



- 2,5 - 3 - 4 - 5,5 mm
- PH 1 - 2
- TX10x80 - TX15x80 - TX20x100 - TX25x100 - TX30x115 - TX40x130
- 125 / 150 mm
- 125 mm
- Ø 3 mm
- Ø 4 mm
- Ø 4 mm
- 10"
- 200 mm
- 200 mm
- 200 mm
- 300 g

Code	Art.-No.	mm	Teile / pcs.	
1893718	2020.035	480 x 340	23	3020



Großer Werkstattwagen

5 Schubladen je 75 mm hoch
 Gewicht: 58 kg
 Gesamtzuladung: 240 kg
 Masse: H 930 x B 700 x T 470 mm
 Farbe: RAL 3002

1 Schublade 225 mm hoch
 Max. Beladung: je Lade 22 kg
 gekröpfter Fahrgriff
 Schublade: 570 x 340 mm

Large tool trolley

5 drawers each 75mm high
 Weight: 58 kg
 Total loading capacity: 240 kg
 Measurements: H 930 x L 700 x W 470 mm
 Colour: RAL 3002

1 drawer 225 mm high
 Max. loading: 22 kg each drawer
 Cranked handle
 Drawer: 570 x 340 mm

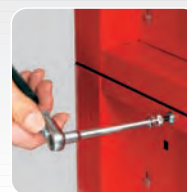
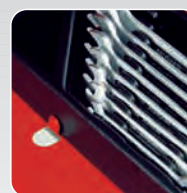
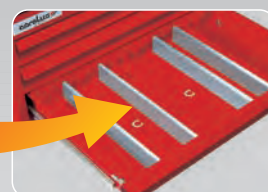
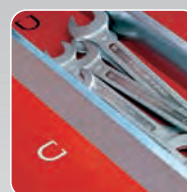

Code	Art.-No.		
1928775	2020.26	ohne Inhalt / without contents	58000

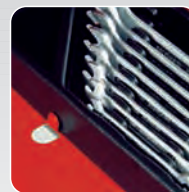
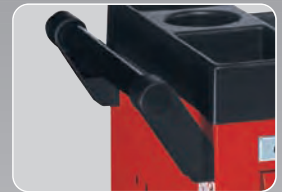

Großer Werkstattwagen

8 Schubladen je 75 mm hoch,
Max. Beladung: je Lade 22 kg
Masse: H 930 x B 700 x T 470 mm
Schublade: 570 x 340 mm

Gewicht: 62 kg
Gesamtzuladung: 240 kg
gekröpfter Fahrgriff
Farbe: RAL 3002

Large tool trolley

8 drawers each 75mm high
Max. loading: 22 kg each drawer
Measurements: H 930 x L 700 x W 470 mm
Drawer: 570 x 340 mm

Weight: 62 kg
Total loading capacity: 240 kg
Cranked handle
Colour: RAL 3002

Code	Art.-No.		
1928783	2020.28	ohne Inhalt / without contents	68000

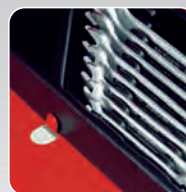
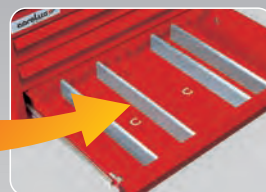
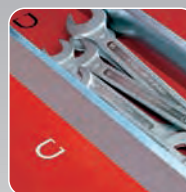

Werkzeugtruhe,

auch als Aufsatzmodul für Werkstattwagen 2020.26 und 2020.28 einsetzbar
 3 Schubladen je 75 mm hoch
 Masse: H 410 x B 700 x T 470 mm
 Schublade: 570 x 340 mm

Gewicht: 26 kg
 Max. Beladung: je Lade 22 kg
 Farbe: RAL 3002

Tool chest

also applicable as top box for tool trolleys 2020.26 and 2020.28
 3 drawers each 75mm high
 Measurements: H 410 x L 700 x W 470 mm
 Drawer: 570 x 340 mm

Weight: 26 kg
 Max. loading: 22 kg each drawer
 Colour: RAL 3002

Code	Art.-No.		
1928759	2020.09	ohne Inhalt / without contents	26000

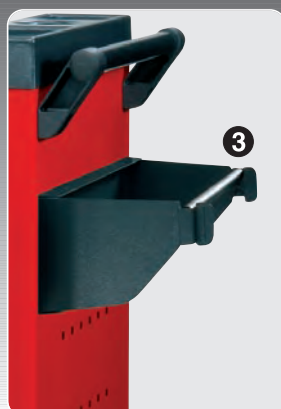

Code	Art.-No.	
1852280	2020.80	1 1000
1852299	2020.81	2 3500
1852302	2020.82	3 3000
1825011	2020.90	1 2 3 7500

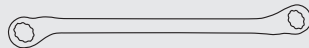

6x7 - 8x9 - 10x11 - 12x13 - 14x15 - 16x17 - 18x19 - 20x22

Code	Art.-No.	mm		
1928996	2020.91	158 x 310		1490



6x7 - 8x9 - 10x11 - 12x13 - 14x15 - 16x17 - 18x19 - 20x22

Code	Art.-No.	mm		
1929003	2020.92	158 x 310		970



10"

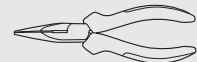

160 mm



180 mm

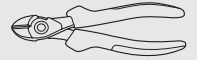

160 mm

Code	Art.-No.	mm		
1929011	2020.93	158 x 310		1100

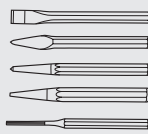

125 / 150 mm
125 mm
Ø 3 mm
Ø 4 mm
Ø 4 mm



300 g

Code	Art.-No.	mm		
1929038	2020.94	158 x 310		1075

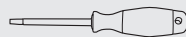
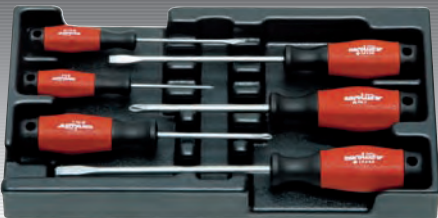

⊖ 3 - 5,5 - 6,5

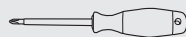

⊕ PH 1 - 2 - 3

Code	Art.-No.	mm		
1929046	2020.95	158 x 310		670



1/2"

○ 10 - 11 - 12 - 13 - 14 - 15 - 16 - 17 - 18 - 19 - 21 - 22 - 23 - 24 - 26 - 27 - 28 - 30 - 32 mm

● 6 - 7 - 8 - 9 - 10 - 12 - 14 mm ↔ mm 60

Code	Art.-No.	mm		
1929054	2020.96	158 x 310		2425

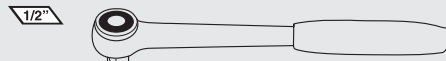

125/ 250 mm

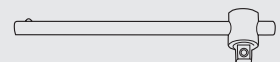
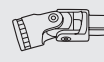

Code	Art.-No.	mm		
1929062	2020.97	158 x 310		1695

Art.-No.	Seite / page	Art.-No.	Seite / page	Art.-No.	Seite / page	Art.-No.	Seite / page	Art.-No.	Seite / page
0100.08	62	0900.17	64	3100.06	42	3720.00	79	4004.99	17
0100.08VK	62	0900.18	64	3100.07	42	3720.02	79	4060.13	44
0100.10	62	0900.19	64	3100.08	42	3720.03	79	4100.00	75
0100.100	62	0900.20	64	3100.09	42	3720.04	79	4115.10	43
0100.12	62	0900.21	64	3100.10	42	3720.05	79	4170.00	46
0100.120	62	0900.210	64	3100.15	42	3720.06	79	4172.00	41
0100.120VK	62	0900.22	64	3100.20	42	3720.07	79	4172.10	41
0106.07	62	0900.24	64	3100.25	42	3720.08	79	4172.20	41
0108.09	62	0900.27	64	3100.27	42	3720.10	79	4172.30	41
0108.10	62	0900.30	64	3100.30	42	3720.25	79	4173.10	41
0110.11	62	0900.32	64	3100.40	42	3730.00	79	4173.15	41
0110.13	62	0900.34	64	3130.01	43	3730.02	79	4173.20	41
0112.13	62	1500.08	60	3130.02	43	3730.03	79	4173.25	41
0113.15	62	1500.09	60	3130.03	43	3730.04	79	4173.27	41
0113.17	62	1500.10	60	3130.04	43	3730.05	79	4173.30	41
0114.15	62	1500.11	60	3150.10	42	3730.06	79	4173.40	41
0116.17	62	1500.12	60	3150.15	42	3730.08	79	4174.05	41
0116.18	62	1500.13	60	3150.20	42	3730.10	79	4174.06	41
0117.19	62	1500.14	60	3150.25	42	3730.25	79	4174.07	41
0118.19	62	1500.15	60	3150.27	42	3740.00	79	4174.08	41
0119.22	62	1500.16	60	3150.30	42	3740.07	79	4174.10	41
0120.22	62	1500.17	60	3150.40	42	3740.08	79	4175.01	40
0121.23	62	1500.18	60	3200.30	42	3740.09	79	4175.02	40
0122.24	62	1500.19	60	3200.45	42	3740.10	79	4175.03	40
0124.26	62	1500.22	60	3200.55	42	3740.15	79	4175.04	40
0124.27	62	1500.24	60	3200.60	42	3740.20	79	4175.05	40
0124.30	62	1500.27	60	3200.65	42	3740.25	79	4175.06	40
0125.28	62	1500.30	60	3200.80	42	3740.27	79	4175.07	40
0127.30	62	1500.32	60	3300.02	42	3740.30	79	4175.08	40
0127.32	62	1500.34	60	3300.03	42	3740.40	79	4175.09	40
0130.32	62	1500.36	60	3300.04	42	3810.03	78	4175.10	40
0132.36	62	1507.00	60	3300.05	42	3810.04	78	4175.11	40
0136.41	62	1512.00	60	3300.06	42	3810.05	78	4175.12	40
0300.15	65	1520.00	61	3300.08	42	3810.06	78	4175.13	41
0300.20	65	2010.07	84	3400.01	42	3810.08	78	4175.14	41
0300.25	65	2010.10	84	3400.02	42	3810.10	78	4175.15	41
0400.00	65	2010.12	84	3400.03	42	3810.25	78	4175.16	41
0450.00	65	2020.031	91	3500.01	43	3820.08	78	4175.17	41
0450.01	65	2020.032	91	3500.02	43	3820.09	78	4175.18	41
0500.08	63	2020.033	91	3500.03	43	3820.10	78	4176.04	40
0500.08VK	63	2020.034	91	3600.00	73	3820.15	78	4176.05	40
0500.10	63	2020.035	91	3600.03	70	3820.20	78	4176.06	40
0500.100	63	2020.036	91	3600.04	70	3820.25	78	4176.07	40
0500.12	63	2020.07	84	3600.08	70	3820.27	78	4176.08	40
0500.120	63	2020.09	94	3600.10	70	3820.30	78	4176.09	40
0500.120VK	63	2020.10	84	3600.55	70	3820.40	78	4176.10	40
0506.07	63	2020.14	90	3600.65	70	3900.10	56	4176.11	40
0508.09	63	2020.26	92	3603.00	72	3900.20	56	4176.12	40
0508.10	63	2020.28	93	3604.00	72	3900.30	57	4176.13	40
0510.11	63	2020.80	94	3605.12	73	3900.40	57	4176.45	40
0510.13	63	2020.81	94	3605.15	73	3900.50	57	4176.55	40
0512.13	63	2020.82	94	3610.08	70	3900.60	57	4177.04	40
0512.14	63	2020.90	94	3610.10	70	3900.70	57	4177.05	40
0513.14	63	2020.91	95	3610.55	70	4002.40	44	4177.06	40
0513.15	63	2020.92	95	3610.65	70	4002.42	44	4177.07	40
0513.17	63	2020.93	95	3620.04	70	4002.43	76	4177.08	40
0514.15	63	2020.94	95	3620.65	70	4002.44	76	4177.09	40
0516.17	63	2020.95	95	3630.00	70	4002.45	76	4177.10	40
0516.18	63	2020.96	95	3630.01	70	4002.46	76	4177.11	40
0517.19	63	2020.97	95	3630.02	70	4003.80	78	4177.12	40
0518.19	63	2030.18N	82	3630.03	70	4003.87	78	4177.13	40
0519.22	63	2030.20N	82	3635.00	73	4003.86	74	4177.14	40
0520.22	63	2040.16N	82	3636.00	73	4003.86A	74	4177.20	5
0521.23	63	2040.20N	82	3640.00	70	4003.93	74	4177.25	46
0522.24	63	2041.16	82	3640.01	70	4003.94	75	4177.26	5
0524.26	63	2042.16	83	3640.02	70	4003.95	74	4177.27	46
0524.27	63	2045.11	73	3640.03	70	4003.96	74	4177.45	40
0524.30	63	2050.16N	82	3650.01	71	4003.97	75	4177.55	40
0525.28	63	2050.20N	82	3650.02	71	4004.15	18	4178.03	41
0527.30	63	2050.30	82	3660.01	71	4004.20	18	4178.04	41
0527.32	63	2055.13	73	3660.02	71	4004.30	18	4178.05	41
0530.32	63	2060.18	83	3670.03	72	4004.47	16	4178.06	41
0532.36	63	2061.17	83	3670.04	72	4004.49	17	4178.08	41
0536.41	63	2070.18	83	3670.25	72	4004.57	16	4178.10	41
0900.06	64	2071.17	83	3670.55	72	4004.59	17	4178.50	44
0900.07	64	2090.13	73	3680.01	72	4004.65	19	4178.60	44
0900.08	64	2175.10	84	3680.02	72	4004.75	19	4179.00	42
0900.080	64	2175.15	84	3690.00	72	4004.76	20	4179.04	41
0900.080VK	64	2175.20	84	3690.06	71	4004.77	16	4179.10	41
0900.090	64	2175.30	84	3690.07	71	4004.78	20	4179.15	42
0900.100	64	2176.05	84	3690.08	71	4004.79	17	4179.20	41
0900.09	64	2176.10	84	3690.09	71	4004.80	12	4179.30	41
0900.10	64	2176.15	84	3690.10	71	4004.80tk	12	4179.40	41
0900.11	64	2176.20	84	3690.15	71	4004.81	13	4179.50	42
0900.110	64	2176.30	84	3690.20	71	4004.81tk	13	4179.55	41
0900.112	64	2179.05	84	3690.25	71	4004.84	14	4179.65	41
0900.117	64	2179.10	84	3690.27	71	4004.85	12	4179.70	44
0900.12	64	2179.15	84	3690.30	71	4004.86	13	4179.80	44
0900.120	64	2179.20	84	3690.40	71	4004.87	14	4179.94	44
0900.120VK	64	2179.30	84	3690.45	71	4004.87tk	14	4200.00	77
0900.122	64	3000.07	58	3695.00	73	4004.89	14	4244.00	77
0900.122VK	64	3000.08	58	3695.05	73	4004.90	12	4244.01	77
0900.13	64	3000.21	56	3695.06	73	4004.91	13	4244.07	77
0900.14	64	3000.40	56	3695.07	73	4004.96	20	4244.08	77
0900.15	64	3000.60	56	3695.08	73	4004.97	16	4244.09	77
0900.16	64	3000.71	56	3710.03	71	4004.98	20	4244.15	77

Art.-No.	Seite / page	Art.-No.	Seite / page	Art.-No.	Seite / page	Art.-No.	Seite / page	Art.-No.	Seite / page
4244.18	77	5112.28	49	5430.18	50	6100.15	47	7210.13	45
4244.25	77	5112.30	49	5430.20	50	6100.16	47	7220.08	45
4244.30	77	5112.32	49	5430.22	50	6100.17	47	7220.09	45
4386.01	75	5115.19	52	5430.24	50	6100.18	47	7220.10	45
4386.02	75	5120.10	52	5530.00	33	6100.19	47	7220.11	45
4386.03	75	5120.25	52	5535.00	34	6100.22	47	7220.12	45
4386.05	75	5125.00	8	5540.00	34	6100.24	47	7220.13	45
4386.08	43	5130.00	52	5560.00	33	6120.10	48	7225.00	4
4386.10	75	5135.05	51	5565.00	34	6120.25	48	7226.00	5
4386.20	75	5135.06	51	5575.00	33	6125.00	6	7230.08	45
4386.27	75	5135.07	51	5575.15	50	6126.00	10	7230.09	45
4386.30	75	5135.08	51	5576.00	33	6126.25	55	7230.10	45
4386.50	75	5135.09	51	5600.00	29	6130.00	48	7230.11	45
4500.00	19	5135.10	51	5690.00	29	6150.15	47	7230.12	45
4590.00	19	5135.11	51	5800.00	31	6150.45	47	7230.13	45
5000.00	28	5135.12	51	5811.00	21	6151.15	47	7270.25tk	4
5011.00	21	5135.14	51	5811.90	21	6151.25	47	7270.26tk	5
5011.90	21	5135.17	51	5815.25	30	6151.30	47	7290.30	4
5012.00	28	5136.05	51	5825.25	30	6190.00	6	8100.00	35
5012.90	28	5136.06	51	5890.30	32	6190.20	7	8100.19	53
5015.00	27	5136.08	51	5890.90	32	6190.30	7	8100.21	53
5025.00	27	5138.07	51	5898.70	30	6190.35	48	8100.22	53
5090.00	28	5139.08	51	5899.35	31	6190.40	10	8100.24	53
5098.00	27	5140.00	52	5899.70	31	6200.01	47	8100.27	53
5099.00	27	5141.06	51	5900.10	66	6200.02	47	8100.30	53
5100.00	29	5141.10	51	5900.20	66	6200.03	47	8100.32	53
5100.10	49	5141.12	51	5900.60	66	6200.04	47	8100.33	53
5100.11	49	5141.14	51	6015.13	55	6200.05	47	8100.36	53
5100.12	49	5142.05	51	6015.15	48	6200.06	47	8100.38	53
5100.13	49	5150.12	51	6035.04	54	6200.07	47	8100.41	53
5100.14	49	5150.25	51	6035.05	54	6200.08	47	8100.46	53
5100.15	49	5150.75	51	6035.06	54	6200.09	47	8100.50	53
5100.16	49	5151.12	52	6035.07	54	6225.00	6	8100.55	53
5100.17	49	5151.25	52	6035.08	54	6290.00	6	8100.60	53
5100.18	49	5151.37	52	6035.10	54	6300.04	47	8106.17	53
5100.19	49	5160.00	52/55	6035.12	54	6300.05	47	8106.18	53
5100.20	49	5170.00	9	6035.14	54	6300.06	47	8106.19	53
5100.21	49	5180.16	50	6038.04	54	6300.07	47	8106.22	53
5100.22	49	5180.21	50	6038.05	54	6300.08	47	8106.24	53
5100.23	49	5190.00	8	6038.06	54	6300.10	47	8106.26	53
5100.24	49	5190.20	9	6038.07	54	6300.12	47	8106.27	53
5100.26	49	5190.30	9	6038.08	54	6300.14	47	8106.29	53
5100.27	49	5190.35	52	6038.10	54	6300.16	47	8106.30	53
5100.28	49	5225.00	8	6045.05	55	6400.25	37	8106.32	53
5100.30	49	5290.00	8	6045.06	55	6400.26	37	8106.33	53
5100.32	49	5300.10	50	6045.08	55	6460.10	36	8106.34	53
5106.10	49	5300.11	50	6045.10	55	6460.20	36	8106.35	53
5106.12	49	5300.12	50	6045.12	55	6460.21	36	8106.36	53
5106.13	49	5300.14	50	6048.06	55	6460.30	36	8106.38	53
5106.14	49	5300.16	50	6048.08	55	6460.40	36	8106.41	53
5106.15	49	5300.18	50	6048.10	55	6460.50	36	8130.00	53
5106.17	49	5300.20	50	6048.12	55	6490.25	37	8140.00	53
5106.19	49	5300.22	50	6055.04	54	6490.26	37	8150.20	53
5106.21	49	5300.24	50	6055.05	54	6790.00	21	8150.40	53
5106.22	49	5303.30	51	6055.06	54	6815.25	26	8160.00	53
5106.23	49	5303.40	51	6055.07	54	6825.25	26	8170.00	10
5106.24	49	5303.45	51	6055.08	54	6850.00	25	8560.00	34
5106.27	49	5303.50	51	6055.10	54	6851.00	25	9000.00	87
5106.30	49	5303.55	51	6060.13	48	6852.00	24	9110.00	88
5106.32	49	5303.60	51	6060.15	48	6852.90	24	9110.10	88
5111.01	49	5303.70	51	6060.17	48	6853.00	24	9111.00	88
5111.02	49	5400.10	50	6070.00	48	6853.90	24	9111.11	88
5111.03	49	5400.11	50	6070.10	48/55	6860.00	23	9112.00	88
5111.04	49	5400.12	50	6070.40	55	6861.00	23	9112.12	88
5111.05	49	5400.13	50	6070.50	52/55	6862.00	22	9200.00	86
5111.06	49	5400.14	50	6070.60	48	6862.90	22	9200.10	86
5111.07	49	5400.15	50	6070.00	55	6863.00	22	9200.20	86
5111.08	49	5400.16	50	6080.16	47	6863.90	22	9200.30	86
5111.09	49	5400.17	50	6080.21	47	6898.70	26	9200.50	86
5111.10	49	5400.19	50	6095.20	54	6899.35	26	9200.80	86
5111.11	49	5400.21	50	6095.25	54	6899.70	26	9250.00	86
5111.12	49	5400.22	50	6095.27	54	6926.00	58	9260.50	86
5111.13	49	5400.24	50	6095.30	54	6926.30	58	9270.02	86
5111.14	49	5400.27	50	6095.40	54	7000.15tk	15	9280.22	86
5111.15	49	5400.30	50	6095.45	54	7000.20tk	15	9280.32	86
5111.16	49	5400.32	50	6095.50	54	7000.30tk	15	9280.40	86
5111.17	49	5406.10	50	6095.55	54	7055.00	43	9281.22	86
5111.18	49	5406.11	50	6095.60	54	7060.00	43	9281.32	86
5112.00	29	5406.12	50	6096.20	54	7070.00	43	9281.40	86
5112.10	49	5406.13	50	6096.25	54	7075.00	43	9290.30	87
5112.11	49	5406.14	50	6096.27	54	7080.00	44	9290.40	87
5112.12	49	5406.15	50	6096.30	54	7080.50	44	9290.50	87
5112.13	49	5406.16	50	6096.40	54	7126.10	46	9291.30	87
5112.14	49	5406.17	50	6096.45	54	7190.30	5	9291.40	87
5112.15	49	5406.19	50	6096.50	54	7190.35	46	9291.50	87
5112.16	49	5406.21	50	6096.55	54	7200.00tk	45	9410.00	87
5112.17	49	5406.22	50	6096.60	54	7200.25	45	9420.00	87
5112.18	49	5406.24	50	6098.40	54	7200.26	45	9430.00	87
5112.19	49	5430.06	50	6098.45	54	7200.30	45		
5112.20	49	5430.07	50	6098.55	54	7200.35	4		
5112.21	49	5430.08	50	6100.08	47	7200.35tk	4		
5112.22	49	5430.10	50	6100.10	47	7210.08	45		
5112.23	49	5430.11	50	6100.11	47	7210.09	45		
5112.24	49	5430.12	50	6100.12	47	7210.10	45		
5112.26	49	5430.14	50	6100.13	47	7210.11	45		
5112.27	49	5430.16	50	6100.14	47	7210.12	45		

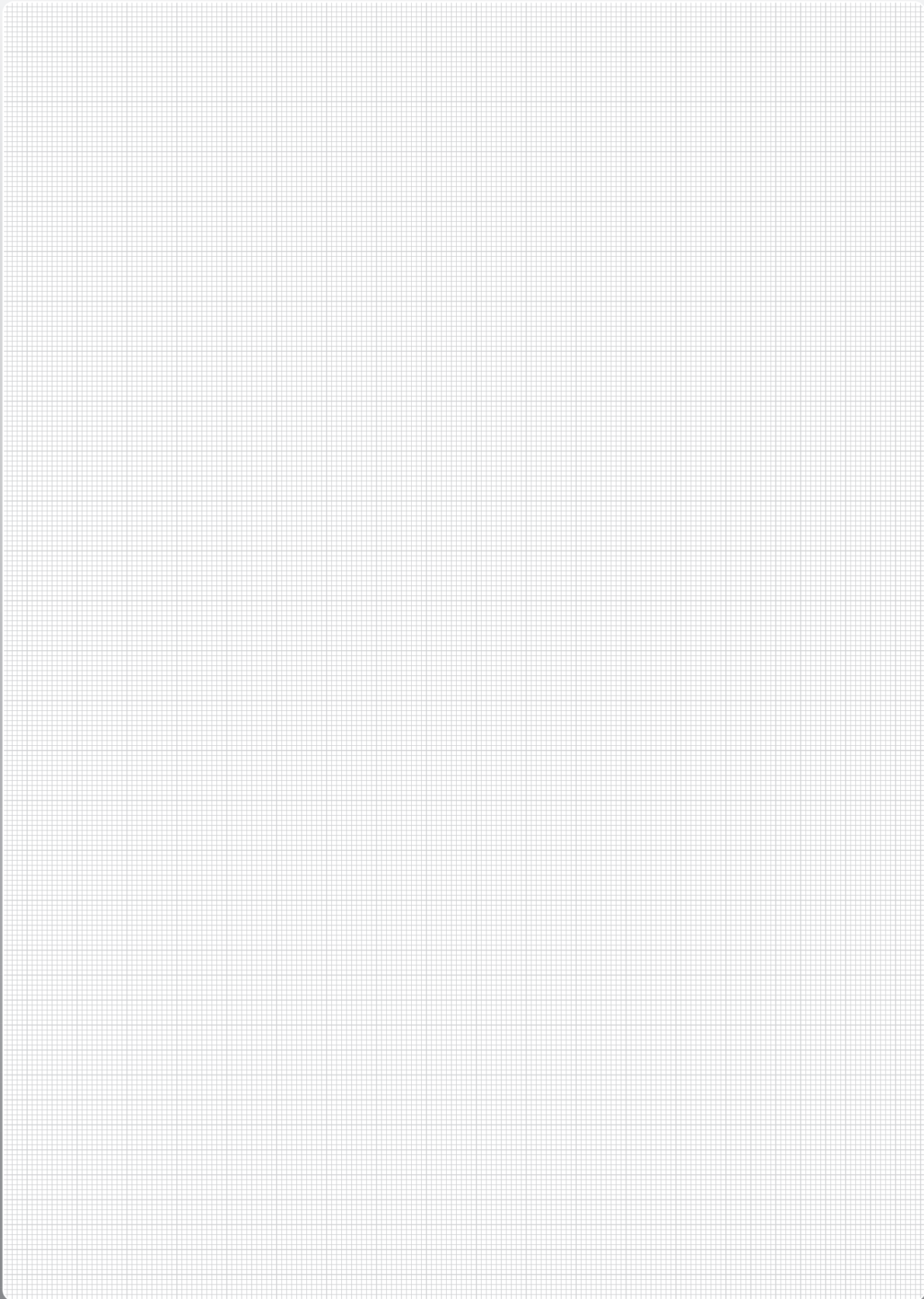

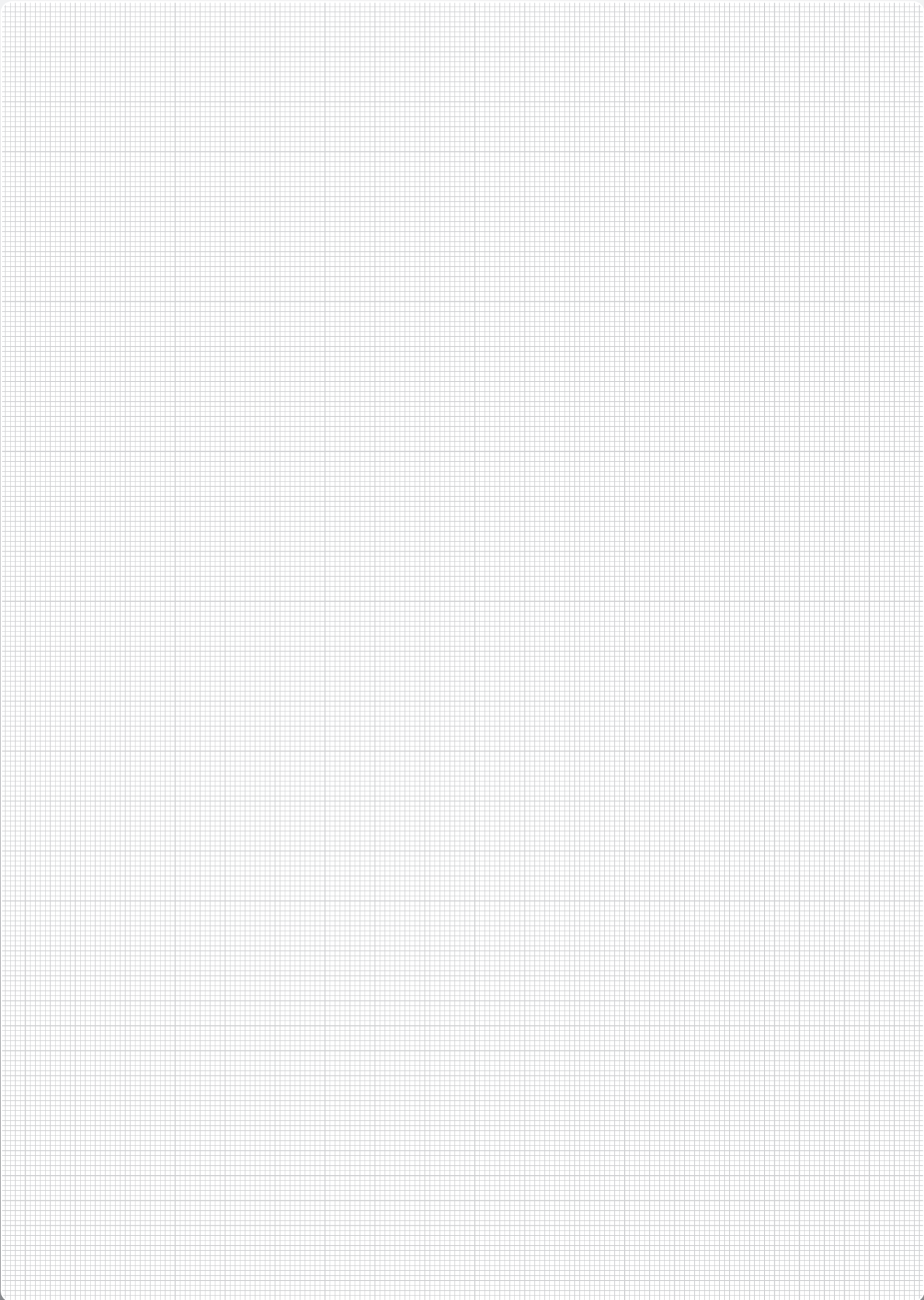

carolus



carolus 
Eine Marke der **GEDORE**  Gruppe

GEDORE Tool Center KG
Remscheider Str. 149
42899 Remscheid · GERMANY
Amtsgericht Wuppertal, HRA 17944
gtc@gedore.de · www.gedore.com

Vertrieb DEUTSCHLAND
Fon + 49 (0) 21 91 - 596 - 900
Fax + 49 (0) 21 91 - 596 - 999

Sales INTERNATIONAL
Fon + 49 (0) 21 91 - 596 - 910
Fax + 49 (0) 21 91 - 596 - 911

Technische Änderungen bleiben vorbehalten · Technical specifications are subject to change without notice