

optibelt

Industrie-Riemen + Metall
Industrial Belts + Metal

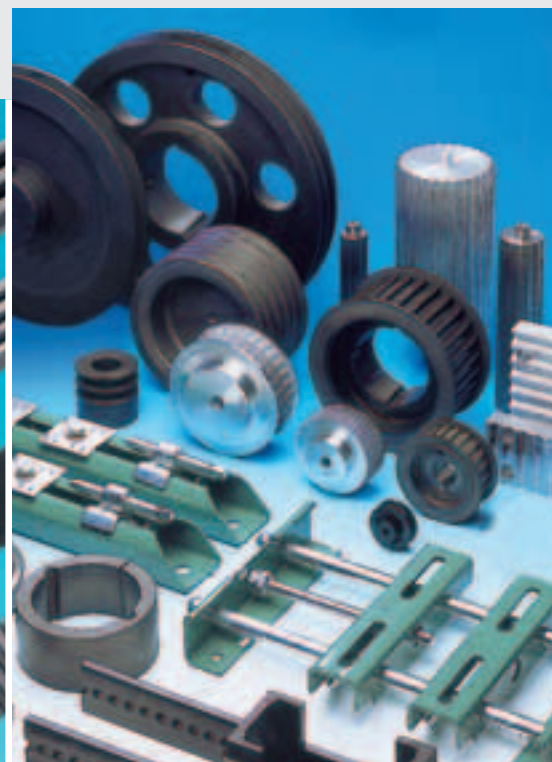

Ausgabe 2006
Edition 2006

Sortimentsliste Product Range

Inhaltsverzeichnis

Contents

Keilriemen Kraftbänder

optibelt 5K Schmalkeilriemen DIN 7753 Teil 1/ISO 4184	8-9
Schmalkeilriemen USA-Standard RMA/MPTA	10
optibelt RED POWER II Hochleistungs-Schmalkeilriemen DIN 7753 Teil 1/ISO 4184	11
Hochleistungs-Schmalkeilriemen USA-Standard RMA/MPTA	12
optibelt VB / VB-LC Klassische Keilriemen DIN 2215/ISO 4184	13-17
optibelt LD Light-Duty-Keilriemen nach USA-Standard RMA/MPTA	17
optibelt Super X-POWER M=5 Schmalkeilriemen – flankenoffen, formgezahnt	18-19
optibelt SUPER TX M=5 Klassische Keilriemen – flankenoffen, formgezahnt	20
optibelt SUPER VX Breitkeilriemen – flankenoffen, formgezahnt	21-23
optibelt KB Kraftbänder mit Schmalkeilriemen	24-25
optibelt RED POWER II Kraftbänder mit Hochleistungs-Schmalkeilriemen.....	26-27
optibelt KB Kraftbänder mit klassischen Keilriemen	28
optibelt KBX Kraftbänder – flankenoffen, formgezahnt	29
optibelt PKR Endlose Keilriemen DIN 2215 mit Auflage	30
optibelt KB Kraftbänder mit Auflage	31

1

Wedge Belts Kraftbands

optibelt 5K Wedge Belts to BS 3790, DIN 7753 and USA Standard RMA/MPTA	8-9
Wedge Belts to USA Standard RMA/MPTA	10
optibelt RED POWER II High Performance Wedge Belts to BS 3790, DIN 7753 Part 1/ISO 4184	11
High Performance Wedge Belts to USA Standard RMA/MPTA	12
optibelt VB / VB-LC V-Belts to BS 3790, DIN 2215 and ISO 4184	13-17
optibelt LD Light Duty V-Belts to USA Standard RMA/MPTA	17
optibelt Super X-POWER M=5 Moulded Cogged, Raw Edge Wedge Belts	18-19
optibelt SUPER TX M=5 Moulded Cogged, Raw Edge V-Belts	20
optibelt SUPER VX Moulded Cogged, Raw Edge Variable Speed Belts	21-23
optibelt KB Kraftbands with Wedge Belts.....	24-25
optibelt RED POWER II Kraftbands with High Performance Wedge Belts	26-27
optibelt KB Kraftbands with Classical V-Belts	28
optibelt KBX Kraftbands with Moulded Cogged, Raw Edge Wedge Belts	29
optibelt PKR Endless V-Belts with Special Top Surfaces	30
optibelt KB Kraftbands with Special Top Surfaces	31

Zahnflachriemen Chloropren

optibelt ZR Zahnflachriemen	34-37
optibelt ZR D Doppel-Zahnflachriemen	37-38
optibelt OMEGA Zahnflachriemen	39-43
optibelt OMEGA HP Hochleistungs-Zahnflachriemen	44-46
optibelt OMEGA HL Hochleistungs-Zahnflachriemen	47
optibelt OMEGA RAINBOW Zahnflachriemen	48
optibelt HTD® Zahnflachriemen	49
optibelt HTD® D Doppel-Zahnflachriemen	50
optibelt STD® Zahnflachriemen	51-52
optibelt STD® D Doppel-Zahnflachriemen	53
optibelt ZR linear Endliche Zahnflachriemen aus Chloropren	54
optibelt HTD® linear Endliche Zahnflachriemen aus Chloropren	54
optibelt OMEGA linear optibelt OMEGA HP linear Endliche Zahnflachriemen aus Chloropren	55

2

Timing Belts Chloroprene

optibelt ZR Timing Belts	34-37
optibelt ZR D Double Timing Belts	37-38
optibelt OMEGA Timing Belts	39-43
optibelt OMEGA HP High Performance Timing Belts	44-46
optibelt OMEGA HL High Performance Timing Belts	47
optibelt OMEGA RAINBOW Timing Belts	48
optibelt HTD® Timing Belts	49
optibelt HTD® D Double Timing Belts	50
optibelt STD® Timing Belts	51-52
optibelt STD® D Double Timing Belts	53
optibelt ZR linear Open-Ended Timing Belts make from Chloroprene	54
optibelt HTD® linear Open-Ended Timing Belts make from Chloroprene	54
optibelt OMEGA linear optibelt OMEGA HP linear Open-Ended Timing Belts make from Chloroprene	55

Zahnflachriemen Polyurethan

optibelt ALPHA / ALPHA D Zahnflachriemen aus Polyurethan, metrisch	58-60
Doppel-Zahnflachriemen aus Polyurethan, metrisch	61
Zahnflachriemen aus Polyurethan, zöllig	62-63
optibelt ALPHAflex Zahnflachriemen aus Polyurethan, endlos gefertigt.....	64-67
optibelt ALPHA linear / ALPHA V Zahnflachriemen als Meterware (endlich) oder endlos verschweißt	68-69
optibelt ALPHA linear – F Endliche Flachriemen aus Polyurethan	70
optibelt ALPHA SRP / ALPHA Spezial Spezialriemen aus Polyurethan	71
optibelt CP Spannplatten	72-73

3

Timing Belts Polyurethane

optibelt ALPHA / ALPHA D Polyurethane Timing Belts, Metric	58-60
Polyurethane Double Timing Belts, Metric	61
Polyurethane Timing Belts, Inch	62-63
optibelt ALPHAflex Polyurethane Timing Belts, Manufactured Endless	64-67
optibelt ALPHA linear / ALPHA V Open-Ended or Joined Endless Polyurethane Timing Belts.....	68-69
optibelt ALPHA linear – F Open-Ended Polyurethane Flat Belts	70
optibelt ALPHA SRP / ALPHA Spezial Timing Belts for Special Applications	71
optibelt CP Clamping Plates	72-73

Riemen für spezielle Anwendungen

optibelt RB Rippenbänder.....	76-77
optibelt DK Doppelkeilriemen	78
optibelt KK Kunststoffkeilriemen Kunststoffkeilriemen mit Aufprofilierung Kunststoffkeilriemen mit Spitzdachprofil.....	79
optibelt RR / RR PLUS Kunststoffrundriemen.....	80
Verbindungswerkzeuge.....	80
optimat OE Endliche Keilriemen DIN 2216, gelocht.....	81
optimat DK Endliche Doppelkeilriemen, gelocht.....	81
optimat FK Endliche Förderbandkeilriemen, gelocht.....	82
optimat PKR Endliche Keilriemen DIN 2216 mit Auflage	83
optibelt LB Gliederkeilriemen.....	83
optibelt RF Gummigewebetreibriemen Type B 50	84
optibelt CF Seilcordflachriemen.....	84
optimax HF Endlose Hochleistungs-Flachriemen.....	85
optibelt WR Weitwinkelriemen aus Polyurethan	86

4

Belts for special applications

optibelt RB Ribbed Belts	76-77
optibelt DK Double V-Belts	78
optibelt KK Polyurethane V-Belts Polyurethane V-Belts with Special Top Surfaces Polyurethane V-Belts with Profiled Carrying Surfaces...	79
optibelt RR / RR PLUS Polyurethane Round Section Belts	80
Splicing Tools	80
optimat OE Open-Ended V-Belts DIN 2216, Punched	81
optimat DK Open-Ended Double V-Belts, Punched	81
optimat FK Open-Ended Conveyor Belts, Punched	82
optimat PKR Open-Ended V-Belts DIN 2216 with Special Top Surfaces	83
optibelt LB Link Belts	83
optibelt RF Rubber Covered Flat Belts Type B 50	84
optibelt CF Cable Cord Flat Belts	84
optimax HF High Performance Flat Belts	85
optibelt WR Polyurethane Wide-Angle Belts	86

Metall

5

Metal

optibelt TB
Taper-Buchsen 89

Ausführungen der **optibelt K5**
Keilrillenscheiben, Auswuchten,
Aufschläge für Fertigbohrungen 90

optibelt K5
Keilrillenscheiben
für Taper-Buchsen –
Rillen nach DIN 2211 91-98

optibelt K5
Keilrillenscheiben
für zylindrische Bohrung –
Rillen nach DIN 2211 99-104

optibelt RE
Regelscheiben 105-107

optibelt RBS
Keilrippenscheiben
für Taper-Buchsen 108-112

optibelt RBS
Keilrippenscheiben
für zylindrische Bohrung 112

optibelt F5
Flachriemenscheiben
für Taper-Buchsen 113

optibelt M5
Motorspannschienen 114

optibelt M5
Motorspannschlitten 115

optibelt ZRS
Standard-Zahnscheiben
für zylindrische Bohrung 116-121

optibelt ZRS
Standard-Zahnscheiben
für Taper-Buchsen 122-127

optibelt ZRS
HTD®-Zahnscheiben
für zylindrische Bohrung 128-135

optibelt ZRS
HTD®-Zahnscheiben
für Taper-Buchsen 136-141

optibelt ZRS
Metrische Zahnscheiben
für zylindrische Bohrung, T-Type 142-146

optibelt ZRS
Metrische Zahnscheiben
für zylindrische Bohrung, AT-Type 147-150

optibelt ZRW
Standard-Zahnwellen 151-152

optibelt ZRW
Metrische Zahnwellen 153-154

optibelt TN
Tapernaben 155

optibelt TN
Zwischenhülsen 156

optibelt CE
Spannelemente 157-172

optibelt TB
Taper bushes 89

Types of **optibelt K5**
V-grooved pulleys, balancing,
surcharges for finished bores 90

optibelt K5
V-grooved pulleys
for taper bushes –
grooves to ISO/BS/DIN 91-98

optibelt K5
V-grooved pulleys
for plain boring –
grooves to ISO/BS/DIN 99-104

optibelt RE
Variable speed pulleys 105-107

optibelt RBS
Ribbed belt pulleys
for taper bushes 108-112

optibelt RBS
Ribbed belt pulleys
for plain boring 112

optibelt F5
Flat belt pulleys
for taper bushes 113

optibelt M5
Motor slide rails 114

optibelt M5
Motor slide bases 115

optibelt ZRS
Timing belt pulleys
for plain boring 116-121

optibelt ZRS
Timing belt pulleys
for taper bushes 122-127

optibelt ZRS
HTD® pulleys
for plain boring 128-135

optibelt ZRS
HTD® pulleys
for taper bushes 136-141

optibelt ZRS
Metric timing belt pulleys
for plain boring, T sections 142-146

optibelt ZRS
Metric timing belt pulleys
for plain boring, AT sections 147-150

optibelt ZRW
Timing bars – standard timing belts 151-152

optibelt ZRW
Timing bars – metric timing belts 153-154

optibelt TN
Taper hubs 155

optibelt TN
Adapters 156

optibelt CE
Clamping bushes 157-172

Allgemeine Information

optibelt S=C PLUS, Super X-POWER M=S, SUPER TX M=S	174
optibelt Allgemeine Information	176
optibelt Umrechnungswerte	178-179
optibelt Technische Hilfsmittel	182

6

General Information

optibelt S=C PLUS, Super X-POWER M=S, SUPER TX M=S	175
optibelt General Information	177
optibelt Technical Information	180-181
optibelt Technical Accessories	182

Keilriemen/Kraftbänder Wedge Belts/Kraftbands

optibelt



optibelt RED POWER II



optibelt SK



optibelt VB



optibelt SUPER VX



optibelt SUPER TX M=5
optibelt SUPER X-POWER M=5



optibelt RED POWER II KB



optibelt KB



optibelt KBX

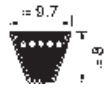

SPZ

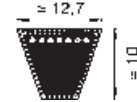

SPA

Profil Section SPZ/3V						Profil Section SPA		
Richtlänge Datum length ISO (mm)	Riemenbez. USA Standard (Zoll inch)	Richtlänge Datum length ISO (mm)	Riemenbez. USA Standard (Zoll inch)	Richtlänge Datum length ISO (mm)	Riemenbez. USA Standard (Zoll inch)	Richtlänge Datum length ISO (mm)	Richtlänge Datum length ISO (mm)	Richtlänge Datum length ISO (mm)
BM BQ = 25 St. pieces						BM BQ = 25 St. pieces		BM BQ = 10 St. pieces
487		1187		2187		732	1582	2307
512		1202	3V 475	2240		757	1600	2332
562		1212		2287	3V 900	782	1607	2360
587		1237				800	1632	2382
612		1250		BM BQ = 10 St. pieces		807	1657	2432
630	3V 250	1262	3V 500	2360		832	1682	2482
637		1287		2500		850	1700	2500
662		1312		2540*	3V 1000	857	1707	2532
670	3V 265	1320		2650		882	1732	2582
687		1337	3V 530	2690*	3V 1060	900	1757	2607
710	3V 280	1347		2800		907	1782	2632
722		1362		2840*	3V 1120	932	1800	2650
737		1387		3000	3V 1180	950	1807	2682
750		1400		3150		957	1832	2732
762	3V 300	1412	3V 560	3350	3V 1320	982	1857	2782
772		1437		3550	3V 1400	1000	1882	2800
787		1462				1007	1900	2832
800	3V 315	1487				1032	1907	2847
812		1500				1060	1932	2882
825		1512				1082	1957	2932
837		1537				1107	1982	2982
850	3V 335	1562				1120	2000	3000
862		1587				1132	2032	3032
875		1600	3V 630			1157	2057	3082
887		1612				1180	2082	3150
900	3V 355	1637				1207	2120	3182
912		1662				1232	2132	3282
925		1687				1250	2182	3350
937		1700	3V 670			1257	2207	3382
950	3V 375	1737				1272	2232	3550
962		1762				1282	2240	3750
987		1787				1307	2282	4000
1000		1800	3V 710			1320	2300	4250
1012	3V 400	1812				1332		4500
1024		1837				1357		
1037		1862				1382		
1047		1887				1400		
1060		1900	3V 750			1407		
1077	3V 425	1937				1432		
1087		1987				1457		
1112		2000				1482		
1120		2037				1500		
1137	3V 450	2120				1507		
1162		2137				1532		
1180		2150*	3V 850			1557		

SPZ / 3V = austauschbare Abmessungen compatible dimensions
(nicht innerhalb eines Riemensatzes kombinierbar
SPZ belts should not be combined into sets with 3V belts to RMA/MPTA)

Maximale Fertigungslänge Maximum manufacturing length: 4500 mm
Mindest-Abnahmemenge Minimum production quantity:
über over 1800 mm =
20 Stück für Zwischenlängen pieces for non standard lengths
60 Stück für bestimmte Sonderausführungen pieces for certain special constructions
Gewicht Belt weight: ≈ 0,074 kg/m

Maximale Fertigungslänge Maximum manufacturing length: 4500 mm
Mindest-Abnahmemenge Minimum production quantity:
über over 1800 mm =
31 Stück für Zwischenlängen pieces for non standard lengths
93 Stück für bestimmte Sonderausführungen pieces for certain special constructions
Gewicht Belt weight: ≈ 0,123 kg/m

Längen in **fetter** Schrift sind in Ausführung S=C PLUS (SatzConstant). • SPZ-Längen = Anfertigungsware.
Lengths in **bold print** are in the S=C PLUS range. • SPZ Lengths = Non stock items.

Richtlänge L_d = Wirklänge L_w/L_p
Datum length L_d = Pitch length L_w/L_p



Profil Section SPB / 5V				Profil Section SPC	
Richtlänge Datum length ISO (mm)	Riemenbezeichnung USA Standard (Zoll inch)	Richtlänge Datum length ISO (mm)	Riemenbezeichnung/ USA Standard (Zoll inch)	Richtlänge Datum length ISO (mm)	
BM BQ = 10 Stück <i>pieces</i>				BM BQ = 10 Stück <i>pieces</i>	
1250		4300•	5V 1700	2000	
1320		4500		2120	
1400		4560•	5V 1800	2240	
1450		4750			
1500		4820•	5V 1900		
1600		5000		BM BQ = 5 Stück <i>pieces</i>	
1700				2360	
1750		BM BQ = 5 Stück <i>pieces</i>		2500	
1800		5070•	5V 2000	2650	
1850		5300		2800	
1900	5V 750	5600		3000	
2000		6000		3150	
2020•	5V 800	6300		3350	
2060		6700		3550	
2120		7100	5V 2800	3750	
2150•	5V 850	7500		4000	
2180		8000	5V 3150	4250	
2240				4500	
2280•	5V 900			4750	
2360				5000	
2400•	5V 950			BM BQ = 3 Stück <i>pieces</i>	
2500				5300	
2650				5600	
2680•	5V 1060			6000	
2800				6300	
2840•	5V 1120			6700	
2850				7100	
2900				7500	
3000				8000	
3150				8500	
3250				9000	
3350	5V 1320			9500	
3450				10000	
3550	5V 1400			10600	
3650				11200	
3750				12500	
3800•	5V 1500				
4000					
4050•	5V 1600				
4250					
SPB / 5V = austauschbare Abmessungen <i>compatible dimensions</i> (nicht innerhalb eines Riemensatzes kombinierbar) SPB belts should not be combined into sets with 5V belts to RMA/MPTA				Profil Section 19 auf Anfrage <i>on request</i>	

Maximale Fertigungslänge *Maximum manufacturing length*: 10000 mm
 Mindest-Abnahmemenge *Minimum production quantity*:
 über over 1800 mm – 2050 mm =
 25 Stück für Zwischenlängen *pieces for non standard lengths*
 75 Stück für bestimmte Sonderausführungen *pieces for certain special constructions*
 über over 2050 mm =
 23 Stück für Zwischenlängen *pieces for non standard lengths*
 69 Stück für bestimmte Sonderausführungen *pieces for certain special constructions*

Gewicht *Belt weight*: ≈ 0,195 kg/m

Maximale Fertigungslänge *Maximum manufacturing length*: 18000 mm
 Mindest-Abnahmemenge *Minimum production quantity*:
 16 Stück für Zwischenlängen *pieces for non standard lengths*
 48 Stück für bestimmte Sonderausführungen *pieces for certain special constructions*

Gewicht *Belt weight*: ≈ 0,377 kg/m

Längen in **fetter** Schrift sind in Ausführung S=C PLUS (SatzConstant). • SPB-Längen = Anfertigungsware.
 Lengths in **bold print** are in the S=C PLUS range. • SPB Lengths = Non stock items.

Richtlänge L_d = Wirklänge L_w/L_p
 Datum length L_d = Pitch length L_w/L_p

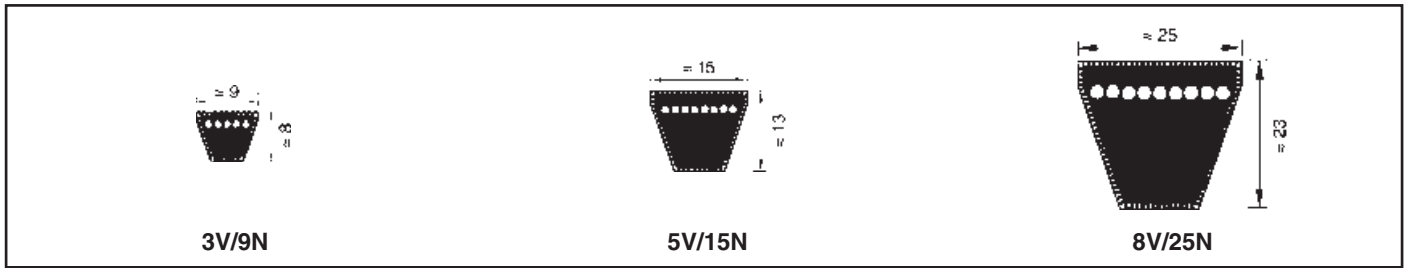

Profil Section 3V/9N		Profil Section 5V/15N		Profil Section 8V/25N	
Riemenbezeichnung Belt no.		Riemenbezeichnung Belt no.		Riemenbezeichnung Belt no.	
(Zoll inch)	Metric reference (Außenlänge Outside length mm)	(Zoll inch)	Metric reference (Außenlänge Outside length mm)	(Zoll inch)	Metric reference (Außenlänge Outside length mm)
BM BQ = 25 Stück pieces		BM BQ = 10 Stück pieces		BM BQ = 1 Stück piece	
3V 250	9N 635	5V 530	15N 1346	8V 1000	25N 2540
3V 265	9N 673	5V 560	15N 1422	8V 1120	25N 2845
3V 280	9N 711	5V 600	15N 1524	8V 1180	25N 2997
3V 300	9N 762	5V 630	15N 1600	8V 1250	25N 3175
3V 315	9N 800	5V 670	15N 1702	8V 1320	25N 3353
3V 335	9N 851	5V 710	15N 1803	8V 1400	25N 3556
3V 355	9N 902	5V 750	15N 1905	8V 1500	25N 3810
3V 375	9N 952	5V 800	15N 2032	8V 1600	25N 4064
3V 400	9N 1016	5V 850	15N 2159	8V 1700	25N 4318
3V 425	9N 1079	5V 900	15N 2286	8V 1800	25N 4572
3V 450	9N 1143	5V 950	15N 2413	8V 1900	25N 4826
3V 475	9N 1206	5V 1000	15N 2540	8V 2000	25N 5080
3V 500	9N 1270	5V 1060	15N 2692	8V 2120	25N 5385
3V 530	9N 1346	5V 1120	15N 2845	8V 2240	25N 5690
3V 560	9N 1422	5V 1180	15N 2997	8V 2360	25N 5994
3V 600	9N 1524	5V 1250	15N 3175	8V 2500	25N 6350
3V 630	9N 1600	5V 1320	15N 3353	8V 2650	25N 6731
3V 670	9N 1702	5V 1400	15N 3556	8V 2800	25N 7112
3V 710	9N 1803	5V 1500	15N 3810	8V 3000	25N 7620
3V 750	9N 1905	5V 1600	15N 4064	8V 3150	25N 8001
3V 800	9N 2032	5V 1700	15N 4318	8V 3350	25N 8509
3V 850	9N 2159	5V 1800	15N 4572	8V 3550	25N 9017
3V 900	9N 2286	5V 1900	15N 4826	8V 3750	25N 9525
BM BQ = 10 Stück pieces		BM BQ = 5 Stück pieces		8V 4000	25N 10160
3V 950	9N 2413	5V 2000	15N 5080	8V 4250	25N 10795
3V 1000	9N 2540	5V 2120	15N 5385	8V 4500	25N 11430
3V 1060	9N 2692	5V 2240	15N 5690	8V 4750	25N 12065
3V 1120	9N 2845	5V 2360	15N 5994	8V 5000	25N 12700
3V 1180	9N 2997	5V 2500	15N 6350		
3V 1250	9N 3175	5V 2650	15N 6731		
3V 1320	9N 3353	5V 2800	15N 7112		
3V 1400	9N 3556	5V 3000	15N 7620		
		5V 3150	15N 8001		
		5V 3350	15N 8509		
		5V 3550	15N 9017		

<p>Max. Fertigungslänge Max. manufacturing length: 4250 mm L_a Mindest-Abnahmemenge Minimum production quantity: über over 1800 mm = 20 Stück für Zwischenlängen pieces for non standard lengths 60 Stück für bestimmte Sonderausführungen pieces for certain special constructions</p> <p>Gewicht Belt weight: ≈ 0,074 kg/m</p>	<p>Max. Fertigungslänge Max. manufacturing length: 10000 mm L_a Mindest-Abnahmemenge Minimum production quantity: über over 1800 mm L_a – 2050 mm L_a 25 St. für Zwischenlängen pieces for non standard lengths 75 St. für bestimmte Sonderausführungen pieces for certain special constructions über over 2050 mm L_a = 23 St. für Zwischenlängen pieces for non standard lengths 69 St. für bestimmte Sonderausführungen pieces for certain special constructions</p> <p>Gewicht Belt weight: ≈ 0,195 kg/m</p>	<p>Max. Fertigungslänge Max. manufacturing length: 18000 mm L_a Über Over 18000 mm L_a bis up to 19000 mm L_a auf Anfrage on request Mindest-Abnahmemenge Minimum production quantity: ab over 2540 mm L_a = 11 St. pieces für Zwischenlängen für non standard lengths 33 St. pieces für bestimmte Sonderausführungen for certain special constructions</p> <p>Gewicht Belt weight: ≈ 0,575 kg/m</p>
--	---	---

<p>Erklärung der Riemenbezeichnung Aus der Riemenbezeichnung lassen sich Profil und Nennlänge ableiten. Da es sich um Schmalkeilriemen nach amerikanischen Normen handelt, beziehen sich alle Maßangaben auf Zoll (1" = 25,4 mm).</p> <p>Belt number explanation The belt number incorporates the belt section identification and the belt length in inches x 10.</p>	<p>Profil Section 3V/9N = obere Breite top width 3/8" / 9 mm 5V/15N = obere Breite top width 5/8" / 15 mm 8V/25N = obere Breite top width 1" / 25,4 mm</p> <p>Längen Lengths z.B. $750 = \frac{750 \cdot 25,4}{10} = 1905$ mm Nennlänge/Außenlänge effect. outside length e.g.</p>
---	--

Längen in **fetter** Schrift sind in Ausführung S=C PLUS (SatzConstant).
 Lengths in **bold print** are in the S=C PLUS range.



Profil Section SPZ		Profil Section SPA		Profil Section SPB	Profil Section SPC
Richtlänge Datum length ISO (mm)		Richtlänge Datum length ISO (mm)		Richtlänge Datum length ISO (mm)	Richtlänge Datum length ISO (mm)
BM BQ = 25 Stück pieces	BM BQ = 10 Stück pieces	BM BQ = 25 Stück pieces		BM BQ = 10 Stück pieces	BM BQ = 10 Stück pieces
1202	2360	1207	2132	1250	2000
1212	2500	1232	2182	1320	2120
1237	2650	1250	2207	1400	2240
1250	2800	1257	2232	1500	
1262	3000	1282	2240	1600	BM BQ = 5 Stück pieces
1287	3150	1307	2282	1700	2360
1312	3350	1320	2300	1800	2500
1320	3550	1332		1900	2650
1337		1357	BM BQ = 10 Stück pieces	2000	2800
1362		1382		2120	3000
1387		1400	2307	2240	3150
1400		1407	2332	2360	3350
1412		1432	2360	2500	3550
1437		1457	2382	2650	3750
1462		1482	2432	2800	4000
1487		1500	2482	3000	4250
1500		1507	2500	3150	4500
1512		1532	2532	3350	4750
1537		1557	2582	3550	5000
1562		1582	2607	3750	
1587		1600	2632	4000	BM BQ = 3 Stück pieces
1600		1607	2650	4250	5300
1612		1632	2682	4500	5600
1637		1657	2732	4750	6000
1662		1682	2782	5000	6300
1687		1700	2800		6700
1700		1707	2832	BM BQ = 5 Stück pieces	7100
1737		1732	2847	5300	7500
1762		1757	2882	5600	8000
1787		1782	2932	6000	8500
1800		1800	2982	6300	9000
1837		1807	3000	6700	9500
1862		1832	3032	7100	10000
1887		1857	3082	7500	
1900		1882	3150	8000	
1937		1900	3182		
1987		1907	3282		
2000		1932	3350		
2037		1957	3382		
2120		1982	3550		
2137		2000	3750		
2187		2032	4000		
2240		2057			
2287		2082			
		2120			

Längen in **fetter** Schrift sind in Ausführung S=C PLUS (SatzConstant).
 Lengths in **bold print** are in the S=C PLUS range.

Richtlänge L_d = Wirklänge L_w/L_p
 Datum length L_d = Pitch length L_w/L_p

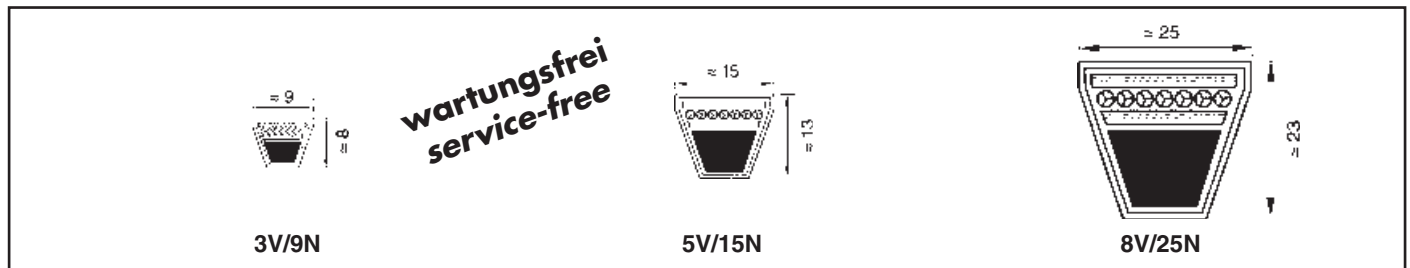

Profil Section 3V/9N		Profil Section 5V/15N		Profil Section 8V/25N	
Riemenbezeichnung <i>Belt no.</i>	Metric reference (Außenlänge Outside length mm)	Riemenbezeichnung <i>Belt no.</i>	Metric reference (Außenlänge Outside length mm)	Riemenbezeichnung <i>Belt no.</i>	Metric reference (Außenlänge Outside length mm)
BM BQ = 25 Stück pieces		BM BQ = 10 Stück pieces		BM BQ = 1 Stück piece	
3V 475	9N 1206	5V 530	15N 1346	8V 1000	25N 2540
3V 500	9N 1270	5V 560	15N 1422	8V 1120	25N 2845
3V 530	9N 1346	5V 600	15N 1524	8V 1180	25N 2997
3V 560	9N 1422	5V 630	15N 1600	8V 1250	25N 3175
3V 600	9N 1524	5V 670	15N 1702	8V 1320	25N 3353
3V 630	9N 1600	5V 710	15N 1803	8V 1400	25N 3556
3V 670	9N 1702	5V 750	15N 1905	8V 1500	25N 3810
3V 710	9N 1803	5V 800	15N 2032	8V 1600	25N 4064
3V 750	9N 1905	5V 850	15N 2159	8V 1700	25N 4318
3V 800	9N 2032	5V 900	15N 2286	8V 1800	25N 4572
3V 850	9N 2159	5V 950	15N 2413	8V 1900	25N 4826
3V 900	9N 2286	5V 1000	15N 2540	8V 2000	25N 5080
BM BQ = 10 Stück pieces		5V 1060	15N 2692	8V 2120	25N 5385
3V 950	9N 2413	5V 1120	15N 2845	8V 2240	25N 5690
3V 1000	9N 2540	5V 1180	15N 2997	8V 2360	25N 5994
3V 1060	9N 2692	5V 1250	15N 3175	8V 2500	25N 6350
3V 1120	9N 2845	5V 1320	15N 3353	8V 2650	25N 6731
3V 1180	9N 2997	5V 1400	15N 3556	8V 2800	25N 7112
3V 1250	9N 3175	5V 1500	15N 3810	8V 3000	25N 7620
3V 1320	9N 3353	5V 1600	15N 4064	8V 3150	25N 8001
3V 1400	9N 3556	5V 1700	15N 4318	8V 3350	25N 8509
		5V 1800	15N 4572	8V 3550	25N 9017
		5V 1900	15N 4826	8V 3750	25N 9525
		BM BQ = 5 Stück pieces		8V 4000	25N 10160
		5V 2000	15N 5080	8V 4250	25N 10795
		5V 2120	15N 5385	8V 4500	25N 11430
		5V 2240	15N 5690	8V 4750	25N 12065
		5V 2360	15N 5994		
		5V 2500	15N 6350		
		5V 2650	15N 6731		
		5V 2800	15N 7112		
		5V 3000	15N 7620		
		5V 3150	15N 8001		
Max. Fertigungslänge <i>Max. manufacturing length</i> : 4000 mm L _a Mindest-Abnahmemenge <i>Minimum production quantity</i> : 1206 mm L _a – 2032 mm L _a = 80 Stück für Zwischenlängen <i>pieces for non standard lengths</i> über over 2032 mm L _a = 98 Stück für Zwischenlängen <i>pieces for non standard lengths</i> Gewicht <i>Belt weight</i> : ≈ 0,074 kg/m		Max. Fertigungslänge <i>Max. manufacturing length</i> : 9525 mm L _a Mindest-Abnahmemenge <i>Minimum production quantity</i> : 1270 mm L _a – 2032 mm L _a = 50 Stück für Zwischenlängen <i>pieces for non standard lengths</i> über over 2032 mm L _a = 72 Stück für Zwischenlängen <i>pieces for non standard lengths</i> Gewicht <i>Belt weight</i> : ≈ 0,195 kg/m		Max. Standard-Fertigungslänge <i>Max. standard manufacturing length</i> : 12065 mm L _a Mindest-Abnahmemenge <i>Minimum production quantity</i> : ab over 2540 mm L _a = 28 Stück für Zwischenlängen <i>pieces for non standard lengths</i> Gewicht <i>Belt weight</i> : ≈ 0,575 kg/m	
Längen in fetter Schrift sind in Ausführung S=C PLUS (SatzConstant). <i>Lengths in bold print are in the S=C PLUS range.</i>			Richtlänge L _d = Wirklänge L _w /L _p Datum length L _d = Pitch length L _w /L _p		

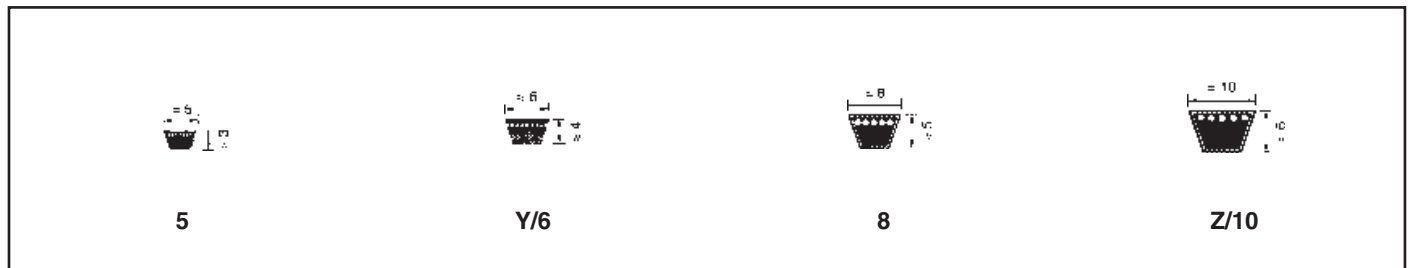

Profil Section 5 ▲		Profil Section 8		Profil Section Z/10					
Richtlänge Dat. length ISO (mm)	Innenlänge Inside length (mm)	Richtlänge Dat. length ISO (mm)	Innenlänge Inside length (mm)	Riemen-Nr. Belt no.	Richtlänge Dat. length ISO (mm)	Innenlänge Inside length (mm)	Riemen-Nr. Belt no.	Richtlänge Dat. length ISO (mm)	Innenlänge Inside length (mm)
BM BQ = 25 St. pieces		BM BQ = 25 St. pieces		BM BQ = 25 Stück pieces					
200	190	335▲	315▲	Z 11	312▲	290▲	Z 45	1172	1150
239	229	375▲	355▲	Z 12 ^{1/2}	337▲	315▲	Z 46	1187	1165
270	260	420▲	400▲	Z 14	397▲	375▲	Z 46 ^{1/2}	1202	1180
290	280	445▲	425▲	Z 15	422▲	400▲	Z 47	1216	1194
310	300	470▲	450▲	Z 16	447▲	425▲	Z 48	1237	1215
325	315	495▲	475▲	Z 17	472▲	450▲	Z 48 ^{1/2}	1247	1225
332	322	510▲	490▲	Z 18	497▲	475▲	Z 49	1272	1250
345	335	550▲	530▲	Z 19	502▲	480▲	Z 50	1292	1270
385	375	580▲	560▲	Z 19 ^{3/4}	522▲	500▲	Z 51	1317	1295
435	425	595▲	575▲	Z 20	537▲	515▲	Z 52	1342	1320
485	475	620▲	600▲	Z 20 ^{1/2}	547▲	525▲	Z 53	1368	1346
510	500	650▲	630▲	Z 21	552▲	530▲	Z 54	1393	1371
540	530	690▲	670▲	Z 21 ^{1/4}	562▲	540▲	Z 55	1422	1400
564	554	720▲	700▲	Z 22	582▲	560▲	Z 56	1444	1422
610	600	730▲	710▲	Z 23	597	575	Z 57	1472	1450
		770▲	750▲	Z 24	622	600	Z 58	1497	1475
		795▲	775▲	Z 25	652	630	Z 59	1522	1500
		820▲	800▲	Z 26	672	650	Z 60	1546	1524
		845	825	Z 27	692	670	Z 61	1572	1550
		870	850	Z 27 ^{1/2}	722	700	Z 62	1597	1575
		895	875	Z 28	732	710	Z 63	1622	1600
		920	900	Z 28 ^{1/2}	747	725	Z 64	1648	1626
		970	950	Z 29	752	730	Z 65	1673	1651
		1020	1000	Z 29 ^{1/2}	772	750	Z 66	1697	1675
		1040	1020	Z 30	787	765	Z 67	1722	1700
		1070	1050	Z 31	797	775	Z 68	1747	1725
		1095	1075	Z 31 ^{1/2}	822	800	Z 69	1772	1750
		1140	1120	Z 32	842	820	Z 70	1797	1775
		1220	1200	Z 33	847	825	Z 71	1822	1800
		1270	1250	Z 33 ^{1/2}	872	850	Z 73	1872	1850
				Z 34	887	865	Z 75	1922	1900
				Z 35	897	875	Z 78	1997	1975
				Z 36	922	900	Z 79	2022	2000
				Z 37	947	925	Z 83 ^{1/2}	2142	2120
				Z 38	972	950	Z 88	2262	2240
				Z 38 ^{1/2}	997	975	BM BQ = 10 Stück pieces		
				Z 39	1022	1000	Z 93	2382	2360
				Z 40	1038	1016	Z 98	2522	2500
				Z 40 ^{1/2}	1052	1030			
				Z 41	1063	1041			
				Z 41 ^{1/2}	1072	1050			
				Z 42	1082	1060			
				Z 43	1102	1080			
				Z 43 ^{1/4}	1122	1100			
				Z 44	1142	1120			
Gewicht Belt weight: ≈ 0,026 kg/m		Gewicht Belt weight: ≈ 0,042 kg/m		Maximale Fertigungslänge Maximum manufacturing length: 4500 mm L _i Mindest-Abnahmemenge Minimum production quantity: über over 1800 mm = 20 Stück für Zwischenlängen pieces for non standard lengths 60 Stück für bestimmte Sonderausführungen pieces for certain special constructions Gewicht Belt weight: ≈ 0,064 kg/m					

Längen in **fetter** Schrift sind in Ausführung S=C PLUS (SatzConstant).
Lengths in **bold print** are in the S=C PLUS range.

▲ Flankenoffen, formgezahnt
▲ Moulded cogged, raw edge V-belts

Richtlänge L_d = Wirklänge L_w/L_p
Datum length L_d = Pitch length L_w/L_p

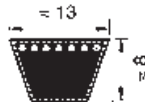

A/13

Profil Section A/13

Riemen-Nr. Belt no.	Richtlänge Datum length ISO (mm)	Innenlänge Inside length (mm)	Riemen-Nr. Belt no.	Richtlänge Datum length ISO (mm)	Innenlänge Inside length (mm)	Riemen-Nr. Belt no.	Richtlänge Datum length ISO (mm)	Innenlänge Inside length (mm)
BM BQ = 25 Stück pieces						BM BQ = 10 Stück pieces		
A 16	437	407	A 49	1280	1250	A 91	2341	2311
A 18	487	457	A 50	1300	1270	A 92	2367	2337
A 19	510	480	A 51	1330	1300	A 93	2390	2360
A 20	538	508	A 52	1350	1320	A 94	2418	2388
A 21	565	535	A 53	1380	1350	A 95	2443	2413
A 22	590	560	A 54	1405	1375	A 96	2468	2438
A 23	605	575	A 55	1430	1400	A 97	2494	2464
A 23 ^{1/2}	630	600	A 56	1452	1422	A 98	2530	2500
A 24	640	610	A 57	1480	1450	A 100	2570	2540
A 25	660	630	A 58	1505	1475	A 102	2621	2591
A 26	680	650	A 59	1530	1500	A 104	2680	2650
A 26 ^{1/2}	700	670	A 60	1555	1525	A 105	2697	2667
A 27	716	686	A 61	1580	1550	A 107	2755	2725
A 27 ^{1/2}	730	700	A 62	1605	1575	A 108	2773	2743
A 28	740	710	A 63	1630	1600	A 110	2830	2800
A 29	760	730	A 64	1655	1625	A 112	2875	2845
A 29 ^{1/2}	780	750	A 65	1680	1650	A 114	2926	2896
A 30	797	767	A 66	1706	1676	A 116	2976	2946
A 31	805	775	A 67	1730	1700	A 118	3030	3000
A 31 ^{1/2}	830	800	A 68	1755	1725	A 120	3078	3048
A 32	843	813	A 69	1780	1750	A 124	3180	3150
A 32 ^{1/2}	855	825	A 70	1805	1775	A 128	3280	3250
A 33	871	841	A 71	1830	1800	A 132	3380	3350
A 34	880	850	A 72	1855	1825	A 136	3484	3454
A 34 ^{1/2}	905	875	A 73	1884	1854	A 140	3580	3550
A 35	919	889	A 74	1910	1880	A 144	3688	3658
A 35 ^{1/2}	930	900	A 75	1930	1900	A 148	3780	3750
A 36	944	914	A 76	1960	1930	A 158	4030	4000
A 37	955	925	A 77	1986	1956	A 167	4280	4250
A 37 ^{1/2}	980	950	A 78	2010	1980	A 187	4780	4750
A 38	995	965	A 79	2030	2000	A 197	5030	5000
A 38 ^{1/2}	1005	975	A 80	2062	2032			
A 39	1030	1000	A 81	2090	2060			
A 40	1046	1016	A 82	2113	2083			
A 40 ^{1/2}	1060	1030	A 83	2130	2100			
A 41	1071	1041	A 83 ^{1/2}	2150	2120			
A 41 ^{1/2}	1080	1050	A 84	2164	2134			
A 42	1090	1060	A 84 ^{1/2}	2180	2150			
A 42 ^{1/2}	1105	1075	A 85	2190	2160			
A 43	1130	1100	A 86 ^{1/2}	2230	2200			
A 43 ^{1/2}	1135	1105	A 87	2240	2210			
A 44	1150	1120	A 88	2270	2240			
A 45	1173	1143	A 89	2291	2261			
A 45 ^{1/2}	1180	1150	A 90	2316	2286			
A 46	1198	1168						
A 46^{1/2}	1210	1180						
A 47	1230	1200						
A 47^{1/2}	1245	1215						
A 48	1250	1220						
A 48^{1/2}	1255	1225						

Maximale Fertigungslänge *Maximum manufacturing length*: 10000 mm L_i
 Mindest-Abnahmemenge *Minimum production quantity*:
 über over 1800 mm =
 31 Stück für Zwischenlängen *pieces for non standard lengths*
 93 Stück für bestimmte Sonderausführungen *pieces for certain special constructions*
 Gewicht *Belt weight*: ≈ 0,109 kg/m

Längen in **fetter** Schrift sind in Ausführung S=C PLUS (SatzConstant).
 Lengths in **bold print** are in the S=C PLUS range.

Richtlänge L_d = Wirklänge L_w/L_p
 Datum length L_d = Pitch length L_w/L_p

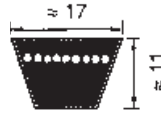

B/17

Profil Section B/17

Riemen-Nr. Belt no.	Richtlänge Dat. length ISO (mm)	Innenlänge Inside length (mm)	Riemen-Nr. Belt no.	Richtlänge Dat. length ISO (mm)	Innenlänge Inside length (mm)	Riemen-Nr. Belt no.	Richtlänge Dat. length ISO (mm)	Innenlänge Inside length (mm)	Riemen-Nr. Belt no.	Richtlänge Dat. length ISO (mm)	Innenlänge Inside length (mm)
BM BQ = 10 Stück <i>pieces</i>						BM BQ = 5 Stück <i>pieces</i>					
B 23	610	570	B 59	1540	1500	B 105	2707	2667	B 208	5340	5300
B 24	655	615	B 60	1565	1525	B 106	2740	2700	B 210	5374	5334
B 25	670	630	B 61	1590	1550	B 107	2758	2718	B 220	5640	5600
B 26	690	650	B 62	1615	1575	B 108	2790	2750	B 236	6040	6000
B 26 ^{1/2}	710	670	B 63	1640	1600	B 110	2840	2800	B 240	6136	6096
B 27	726	686	B 64	1665	1625	B 112	2885	2845	B 248	6340	6300
B 28	750	710	B 65	1690	1650	B 114	2940	2900	B 264	6740	6700
B 29	765	725	B 66	1716	1676	B 115	2961	2921	B 276	7040	7000
B 30	790	750	B 67	1740	1700	B 116	2990	2950	B 280	7140	7100
B 31	815	775	B 68	1765	1725	B 118	3040	3000			
B 32	840	800	B 69	1790	1750	B 120	3088	3048			
B 32 ^{1/2}	865	825	B 69^{1/2}	1801	1761	B 122	3139	3099			
B 33	876	836	B 70	1815	1775	B 124	3190	3150			
B 34	890	850	B 71	1840	1800	B 126	3240	3200			
B 34 ^{1/2}	915	875	B 72	1869	1829	B 128	3290	3250			
B 35	929	889	B 73	1890	1850	B 130	3342	3302			
B 36	940	900	B 74	1920	1880	B 132	3390	3350			
B 37	965	925	B 75	1940	1900	B 134	3444	3404			
B 37 ^{1/2}	990	950	B 76	1970	1930	B 136	3490	3450			
B 38	1005	965	B 77	1990	1950	B 138	3545	3505			
B 38 ^{1/2}	1015	975	B 78	2021	1981	B 140	3590	3550			
B 39	1040	1000	B 79	2040	2000	B 142	3640	3600			
B 40	1056	1016	B 80	2072	2032	B 144	3698	3658			
B 40 ^{1/2}	1070	1030	B 81	2100	2060	B 146	3740	3700			
B 41	1080	1040	B 82	2123	2083	B 148	3790	3750			
B 41 ^{1/2}	1090	1050	B 83	2140	2100	B 150	3850	3810			
B 42	1100	1060	B 83^{1/2}	2160	2120	B 151	3890	3850			
B 42 ^{1/2}	1115	1075	B 84	2174	2134	B 152	3901	3861			
B 43	1130	1090	B 85	2200	2160	B 154	3952	3912			
B 43 ^{1/4}	1140	1100	B 86	2240	2200	B 155	3990	3950			
B 44	1160	1120	B 87	2250	2210	B 156	4002	3962			
B 45	1190	1150	B 88	2280	2240	B 158	4040	4000			
B 45 ^{1/2}	1203	1163	B 89	2301	2261	B 160	4104	4064			
B 46	1215	1175	B 90	2326	2286	B 162	4155	4115			
B 46^{1/2}	1220	1180	B 91	2340	2300	B 165	4240	4200			
B 47	1240	1200	B 92	2377	2337	B 167	4290	4250			
B 48	1255	1215	B 93	2400	2360	B 173	4434	4394			
B 48^{1/2}	1265	1225	B 94	2428	2388	B 175	4490	4450			
B 49	1290	1250	B 94^{1/2}	2440	2400	B 177	4540	4500			
B 50	1315	1275	B 95	2453	2413	B 180	4612	4572			
B 51	1340	1300	B 96	2478	2438	B 187	4790	4750			
B 52	1360	1320	B 96^{1/2}	2490	2450	B 195	4993	4953			
B 52^{1/2}	1375	1335	B 97	2505	2465	B 197	5040	5000			
B 53	1390	1350	B 98	2540	2500						
B 53^{1/2}	1400	1360	B 99	2555	2515						
B 54	1412	1372	B 100	2580	2540						
B 55	1440	1400	B 101	2605	2565						
B 56	1462	1422	B 102	2640	2600						
B 57	1490	1450	B 103	2656	2616						
B 58	1513	1473	B 104	2690	2650						

Maximale Fertigungslänge *Maximum manufacturing length*: 15500 mm L_i
 Mindest-Abnahmemenge *Minimum production quantity*:
 über over 1800 mm L_i = 2000 mm L_i =
 25 Stück für Zwischenlängen *pieces for non standard lengths*
 75 Stück für bestimmte Sonderausführungen *pieces for certain special constructions*
 über over 2000 mm L_i =
 21 Stück für Zwischenlängen *pieces for non standard lengths*
 63 Stück für bestimmte Sonderausführungen *pieces for certain special constructions*
 Gewicht *Belt weight*: ≈ 0,196 kg/m

Längen in **fetter** Schrift sind in Ausführung S=C PLUS (SatzConstant).
 Lengths in **bold print** are in the S=C PLUS range.

Richtlänge L_d = Wirklänge L_w/L_p
 Datum length L_d = Pitch length L_w/L_p



Profil Section 20		Profil Section C/22								
Richtlänge Datum length ISO (mm)	Innenlänge Inside length (mm)	Riemen-Nr. Belt no.	Richtlänge Datum length ISO (mm)	Innenlänge Inside length (mm)	Riemen-Nr. Belt no.	Richtlänge Datum length ISO (mm)	Innenlänge Inside length (mm)	Riemen-Nr. Belt no.	Richtlänge Datum length ISO (mm)	Innenlänge Inside length (mm)
BM BQ = 10 Stück pieces		BM BQ = 10 Stück pieces			BM BQ = 5 Stück pieces			BM BQ = 3 Stück pieces		
950	900	C 43	1148	1090	C 92	2395	2337	C 170	4376	4318
1050	1000	C 47	1258	1200	C 93	2418	2360	C 173	4452	4394
1170	1120	C 48	1273	1215	C 94	2446	2388	C 175	4503	4445
1230	1180	C 49	1308	1250	C 95	2471	2413	C 177	4558	4500
1300	1250	C 51	1353	1295	C 96	2496	2438	C 180	4630	4572
1370	1320	C 52	1378	1320	C 96 ^{1/2}	2508	2450	C 187	4808	4750
1450	1400	C 53	1408	1350	C 97	2522	2464	C 190	4884	4826
1550	1500	C 54	1433	1375	C 98	2558	2500	C 195	5011	4953
1650	1600	C 55	1458	1400	C 99	2583	2525	C 197	5058	5000
1750	1700	C 56	1483	1425	C 100	2598	2540			
1850	1800	C 57	1508	1450	C 101	2618	2560			
1950	1900	C 58	1533	1475	C 102	2649	2591	C 208	5358	5300
2050	2000	C 59	1558	1500	C 104	2700	2642	C 210	5392	5334
2170	2120	C 60	1582	1524	C 105	2725	2667	C 220	5658	5600
2290	2240	C 61	1608	1550	C 106	2750	2692	C 225	5773	5715
BM BQ = 5 Stück pieces		C 62	1632	1574	C 108	2808	2750	C 236	6058	6000
2410	2360	C 63	1658	1600	C 110	2858	2800	C 240	6154	6096
2550	2500	C 65	1708	1650	C 112	2903	2845	C 248	6358	6300
2700	2650	C 66	1734	1676	C 114	2954	2896	C 264	6758	6700
2850	2800	C 67	1758	1700	C 115	2979	2921	C 270	6916	6858
3050	3000	C 68	1785	1727	C 116	3008	2950	C 280	7158	7100
3200	3150	C 69	1808	1750	C 117	3023	2965	C 295	7558	7500
3400	3350	C 70	1836	1778	C 118	3058	3000	C 300	7678	7620
3600	3550	C 71	1858	1800	C 120	3106	3048	C 315	8058	8000
3800	3750	C 72	1887	1829	C 122	3157	3099			
4050	4000	C 73	1912	1854	C 124	3208	3150			
4550	4500	C 74	1938	1880	C 126	3258	3200			
5050	5000	C 75	1958	1900	C 128	3308	3250			
BM BQ = 3 Stück pieces		C 76	1988	1930	C 130	3360	3302			
6050	6000	C 77	2014	1956	C 132	3408	3350			
		C 78	2039	1981	C 134	3462	3404			
		C 79	2058	2000	C 136	3508	3450			
		C 80	2090	2032	C 138	3563	3505			
		C 81	2118	2060	C 140	3608	3550			
		C 82	2141	2083	C 142	3665	3607			
		C 83	2166	2108	C 144	3716	3658			
		C 83 ^{1/2}	2178	2120	C 146	3758	3700			
		C 84	2192	2134	C 148	3808	3750			
		C 85	2217	2159	C 150	3868	3810			
		C 86	2242	2184	C 158	4058	4000			
		C 87	2268	2210	C 162	4158	4100			
		C 88	2298	2240	C 166	4274	4216			
		C 89	2319	2261	C 167	4308	4250			
		C 90	2344	2286	C 168	4325	4267			
Maximale Fertigungslänge Maximum manufacturing length: 10000 mm L _i Mindest-Abnahmemenge Minimum production quantity: über over 1800 mm L _i – 2000 mm L _i = 21 Stück für Zwischenlängen pieces for non standard lengths 63 Stück für bestimmte Sonderausführungen pieces for certain special constructions über over 2000 mm L _i = 18 Stück für Zwischenlängen pieces for non standard lengths 54 Stück für bestimmte Sonderausführungen pieces for certain special constructions Gewicht Belt weight: ≈ 0,266 kg/m		Maximale Standard-Fertigungslänge Maximum standard manufacturing length: 18000 mm L _i über over 18000 – 19000 mm L _i auf Anfrage on request Mindest-Abnahmemenge Minimum production quantity: über over 1800 mm L _i – 2000 mm L _i = 19 Stück für Zwischenlängen pieces for non standard lengths 57 Stück für bestimmte Sonderausführungen pieces for certain special constructions über over 2000 mm L _i = 16 Stück für Zwischenlängen pieces for non standard lengths 48 Stück für bestimmte Sonderausführungen pieces for certain special constructions Gewicht Belt weight: ≈ 0,324 kg/m								
Längen in fetter Schrift sind in Ausführung S=C PLUS (SatzConstant). Lengths in bold print are in the S=C PLUS range.		Richtlänge L _d = Wirklänge L _w /L _p Datum length L _d = Pitch length L _w /L _p								

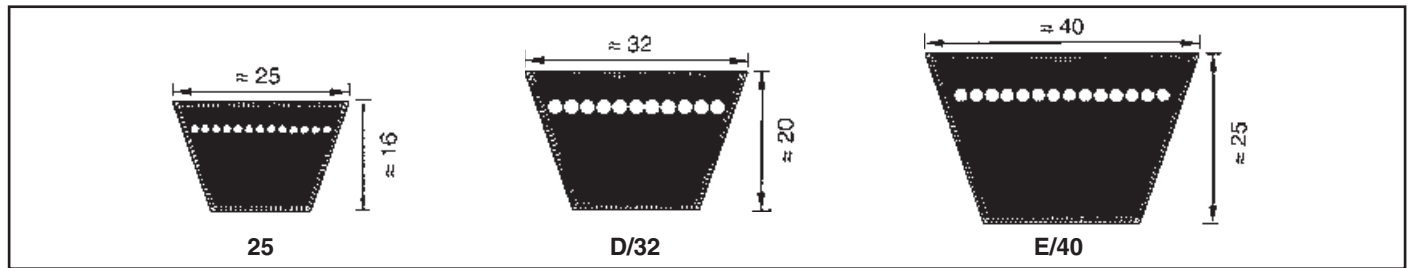

Profil Section 25		Profil Section D/32			Profil Section E/40		
Richtlänge Datum length ISO (mm)	Innenlänge Inside length (mm)	Riemen-Nr. Belt no.	Richtlänge Datum length ISO (mm)	Innenlänge Inside length (mm)	Riemen-Nr. Belt no.	Richtlänge Datum length ISO (mm)	Innenlänge Inside length (mm)
BM BQ = 10 Stück <i>pieces</i>		BM BQ = 1 Stück <i>piece</i>			BM BQ = 1 Stück <i>piece</i>		
1460	1400	D 79	2075	2000	E 118	3080	3000
1560	1500	D 98	2575	2500	E 158	4080	4000
1660	1600	D 104	2725	2650	E 197	5080	5000
1760	1700	D 110	2875	2800	E 220	5680	5600
1860	1800	D 118	3075	3000	E 236	6080	6000
1960	1900	D 120	3123	3048	E 248	6380	6300
2060	2000	D 124	3225	3150	E 280	7180	7100
2180	2120	D 128	3326	3251	E 295	7580	7500
2300	2240	D 132	3425	3350	E 315	8080	8000
		D 135	3500	3425	E 354	9080	9000
BM BQ = 5 Stück <i>pieces</i>		D 136	3529	3454	E 394	10080	10000
2420	2360	D 140	3625	3550	E 441	11280	11200
2560	2500	D 144	3733	3658	E 492	12580	12500
2710	2650	D 148	3825	3750	Anfertigungsware Non stock items		
2760	2700	D 154	4000	3925			
2860	2800	D 158	4075	4000			
3060	3000	D 162	4190	4115			
3210	3150	D 167	4325	4250			
3410	3350	D 173	4469	4394			
3610	3550	D 177	4575	4500			
3810	3750	D 180	4647	4572			
4060	4000	D 187	4825	4750			
4310	4250	D 195	5028	4953			
4560	4500	D 197	5075	5000			
4810	4750	D 208	5375	5300			
5060	5000	D 210	5409	5334			
BM BQ = 3 Stück <i>pieces</i>		D 220	5675	5600	optibelt VB-LC Keilriemen mit hellem Umhüllungsweben V-Belts with Light Coloured Cover Fabric Sortiment Range		
5360	5300	D 225	5790	5715			
5660	5600	D 236	6075	6000			
6060	6000	D 240	6171	6096			
6360	6300	D 248	6375	6300			
6760	6700	D 264	6775	6700			
7160	7100	D 270	6933	6858			
7560	7500	D 280	7175	7100			
8060	8000	D 295	7575	7500			
8560	8500	D 300	7695	7620			
9060	9000	D 315	8075	8000			
		D 330	8457	8382			
		D 335	8575	8500			
		D 354	9075	9000			
		D 374	9575	9500			
		D 394	10075	10000			
		D 441	11275	11200			
Max. Fertigungslänge <i>Max. manufacturing length</i> : 18000 mm L _i über <i>over</i> 1800 mm L _i – 2000 mm L _i = 17 Stück <i>pieces</i> für Zwischenlängen <i>pieces for non standard lengths</i> 51 Stück für bestimmte Sonderausführungen <i>pieces for certain special constructions</i> über <i>over</i> 2000 mm L _i = 14 Stück für Zwischenlängen <i>pieces for non standard lengths</i> 42 Stück für bestimmte Sonderausführungen <i>pieces for certain special constructions</i> Gewicht <i>Belt weight</i> : ≈ 0,420 kg/m		Maximale Standard-Fertigungslänge <i>Maximum standard manufacturing length</i> : 18000 mm L _i über <i>over</i> 18000 – 19000 mm L _i auf Anfrage <i>on request</i> Mindest-Abnahmemenge <i>Minimum production quantity</i> : ab <i>over</i> 2000 mm = 11 Stück für Zwischenlängen <i>pieces for non standard lengths</i> 33 Stück für bestimmte Sonderausführungen <i>pieces for certain special constructions</i> Gewicht <i>Belt weight</i> : ≈ 0,668 kg/m			Max. Fertigungslänge <i>Max. manufacturing length</i> : 19000 mm L _i Mindest-Abnahmemenge <i>Minimum quantities for all sizes</i> : ab <i>over</i> 3000 – 18 000 L _i = 7 Stück für Zwischenlängen <i>pieces for non standard lengths</i> 21 Stück für bestimmte Sonderausführungen <i>pieces for certain special constructions</i> über <i>over</i> 18000 mm L _i auf Anfrage <i>on request</i> Gewicht <i>Belt weight</i> : ≈ 0,958 kg/m		
Längen in fetter Schrift sind in Ausführung S=C PLUS (SatzConstant). <i>Lengths in bold print are in the S=C PLUS range.</i>					Richtlänge L _d = Wirklänge L _w /L _p Datum length L _d = Pitch length L _w /L _p		

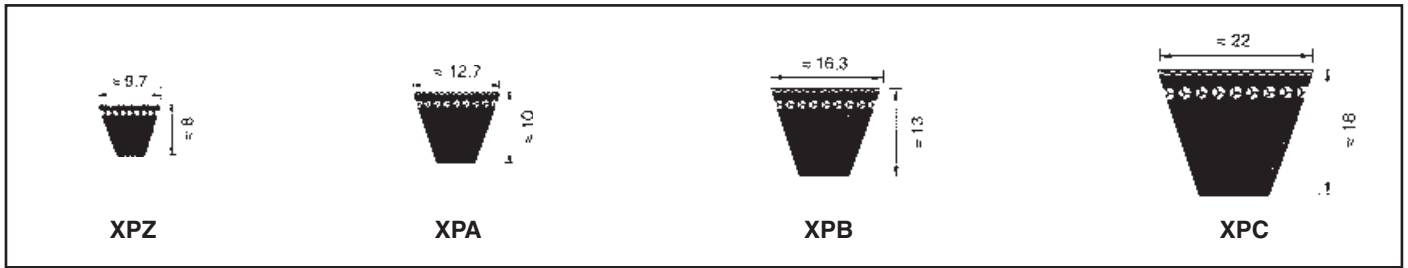

Profil Section XPZ/3VX				Profil Section XPA		Profil Sect. XPB/5VX		Profil Section XPC
Richtlänge Datum length ISO (mm)	Riemenbez. USA Standard (Zoll inch)	Richtlänge Datum length ISO (mm)	Riemenbez. USA Standard (Zoll inch)	Richtlänge Datum length ISO (mm)	Richtlänge Datum length ISO (mm)	Richtlänge Datum length ISO (mm)	Riemenbez. USA Standard (Zoll inch)	Richtlänge Datum length ISO (mm)
BM BQ = 25 Stück pieces				BM BQ = 25 St. pieces		BM BQ = 10 Stück pieces		BM BQ = 10 Stück pieces
587		1262	3VX 500	707	1700	1250		2000
612		1287		732	1750	1320		2120
630	3VX 250	1312		757	1757	1400		2240
637		1320		782	1800	1500		
662		1337	3VX 530	800	1882	1600		
670	3VX 265	1362		807	1900	1700		
687		1387		832	2000	1800		
710	3VX 280	1400		850	2120	1850		
730		1412	3VX 560	857	2240	1900	5VX 750	
737		1437		882		2000		
750		1462		900	BM BQ = 10 St. pieces	2020•	5VX 800	
762	3VX 300	1487		907		2120		
772		1500		932	2360	2150•	5VX 850	
787		1512		950	2500	2240		
800	3VX 315	1537		957	2650	2280•	5VX 900	
812		1562		982	2800	2360		
825		1587		1000	3000	2400•	5VX 950	
837		1600	3VX 630	1007	3150	2500		
850	3VX 335	1612		1030	3350	2650		
862		1662		1060	3550	2680•	5VX 1060	
875		1700	3VX 670	1082		2800		
887		1750		1107		2840•	5VX 1120	
900	3VX 355	1762		1120		3000		
912		1800	3VX 710	1132		3150		
925		1850		1157		3350	5VX 1320	
937		1900	3VX 750	1180		3550	5VX 1400	
950	3VX 375	1950		1207				
962		2000		1232				
987		2120		1250				
1000		2150•	3VX 850	1257				
1012	3VX 400	2240		1272				
1037				1282				
1060		BM BQ = 10 Stück pieces		1307				
1077	3VX 425			1320				
1087		2360		1332				
1112		2500		1357				
1120		2540•	3VX 1000	1382				
1137	3VX 450	2650		1400				
1162		2690•	3VX 1060	1432				
1180		2800		1450				
1187		2840•	3VX 1120	1457				
1202	3VX 475	3000	3VX 1180	1482				
1212		3150		1500				
1237		3350	3VX 1320	1507				
1250		3550	3VX 1400	1532				
				1557				
				1582				
				1600				
				1607				
				1632				
XPZ / 3VX = austauschbare Abmessungen compatible dimensions (nicht innerhalb eines Riemenatzes kombinierbar XPZ belts should not be combined into sets with 3VX belts to RMA/MPTA)						XPB / 5VX = austauschbare Abmessungen compatible dimensions (nicht innerhalb eines Riemenatzes kombinierbar XPB belts should not be combined into sets with 5VX belts to RMA/MPTA)		
Gewicht Belt weight: ≈ 0,065 kg/m				Gewicht Belt weight: ≈ 0,096 kg/m		Gewicht Belt weight: ≈ 0,183 kg/m		Gewicht Belt weight: ≈ 0,340 kg/m

Alle Keilriemen der Ausführung Optibelt Super X-POWER M=S können bei gleicher Nennlänge ungemessen zu Sätzen vereinigt werden.
 Optibelt Super X-POWER M=S Wedge belts of the same length can be used in matched sets, without the need for re-measuring and matching.



3VX/9NX

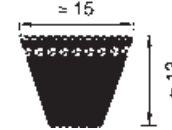

5VX/15NX

Profil Section 3VX/9NX		Profil Section 5VX/15NX	
Riemenbezeichnung Belt no.		Riemenbezeichnung Belt no.	
(Zoll inch)	Metric reference (Außenlänge Effective outside length mm)	(Zoll inch)	Metric reference (Außenlänge Effective outside length mm)
BM BQ = 25 Stück pieces		BM BQ = 10 Stück pieces	
3VX 250	9NX 635	5VX 500	15NX 1270
3VX 265	9NX 673	5VX 530	15NX 1346
3VX 280	9NX 711	5VX 560	15NX 1422
3VX 300	9NX 762	5VX 600	15NX 1524
3VX 315	9NX 800	5VX 630	15NX 1600
3VX 335	9NX 851	5VX 670	15NX 1702
3VX 355	9NX 902	5VX 710	15NX 1803
3VX 375	9NX 952	5VX 750	15NX 1905
3VX 400	9NX 1016	5VX 800	15NX 2032
3VX 425	9NX 1079	5VX 850	15NX 2159
3VX 450	9NX 1143	5VX 900	15NX 2286
3VX 475	9NX 1206	5VX 950	15NX 2413
3VX 500	9NX 1270	5VX 1000	15NX 2540
3VX 530	9NX 1346	5VX 1060	15NX 2692
3VX 560	9NX 1422	5VX 1120	15NX 2845
3VX 600	9NX 1524	5VX 1180	15NX 2997
3VX 630	9NX 1600	5VX 1250	15NX 3175
3VX 670	9NX 1702	5VX 1320	15NX 3353
3VX 710	9NX 1803	5VX 1400	15NX 3556
3VX 750	9NX 1905		
3VX 800	9NX 2032		
3VX 850	9NX 2159		
3VX 900	9NX 2286		
BM BQ = 10 Stück pieces			
3VX 950	9NX 2413		
3VX 1000	9NX 2540		
3VX 1060	9NX 2692		
3VX 1120	9NX 2845		
3VX 1180	9NX 2997		
3VX 1250	9NX 3175		
3VX 1320	9NX 3353		
3VX 1400	9NX 3556		
Gewicht Belt weight: ≈ 0,065 kg/m		Gewicht Belt weight: ≈ 0,183 kg/m	

Alle Keilriemen der Ausführung Optibelt Super X-POWER M=S können bei gleicher Nennlänge ungemessen zu Sätzen vereinigt werden.
 Optibelt Super X-POWER M=S Wedge belts of the same length can be used in matched sets, without the need for re-measuring and matching.

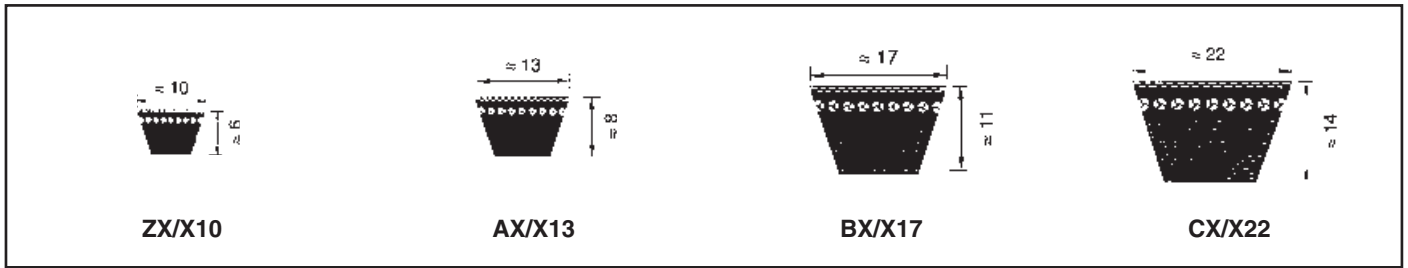

Profil Sect. ZX/X10		Profil Section AX/X13				Profil Section BX/X17				Profil Sect. CX/X22	
Riemen-Nr. Belt no.	Richtlänge Dat. length ISO (mm)	Riemen-Nr. Belt no.	Richtlänge Dat. length ISO (mm)	Riemen-Nr. Belt no.	Richtlänge Dat. length ISO (mm)	Riemen-Nr. Belt no.	Richtlänge Dat. length ISO (mm)	Riemen-Nr. Belt no.	Richtlänge Dat. length ISO (mm)	Riemen-Nr. Belt no.	Richtlänge Dat. length ISO (mm)
BM BQ = 25 St. pieces		BM BQ = 25 St. pieces				BM BQ = 10 St. pieces				BM BQ = 10 St. pieces	
ZX 23	597	AX 23	605	AX 93	2390	BX 23	610	BX 79	2040	CX 39	1058•
ZX 24	622	AX 23 ^{1/2}	630	AX 98	2530•	BX 25	670	BX 88	2280	CX 43	1148•
ZX 25	652	AX 24	640	AX 104	2680•	BX 26	690	BX 93	2400	CX 49	1308•
ZX 26	672	AX 25	660	AX 110	2830•	BX 28	750	BX 98	2540	CX 52	1378•
ZX 27	692	AX 26 ^{1/2}	700	AX 118	3030•	BX 29	765	BX 103	2656•	CX 55	1458•
ZX 28	732	AX 27	716	AX 124	3180•	BX 30	790	BX 104	2690•	CX 59	1558•
ZX 29	752	AX 28	740	AX 132	3380•	BX 31	815	BX 110	2840•	CX 62	1632•
ZX 29 ^{1/2}	772	AX 29	760			BX 32	840	BX 118	3040•	CX 67	1758•
ZX 31 ^{1/2}	822	AX 30	797			BX 33	876	BX 124	3190•	CX 68	1785•
ZX 32	842	AX 31	805			BX 34	890	BX 132	3390•	CX 71	1858•
ZX 33	847	AX 32	843			BX 34 ^{1/2}	915			CX 75	1958•
ZX 33 ^{1/2}	872	AX 33	871			BX 35	929			CX 79	2058•
ZX 35	897	AX 34	880			BX 36	940			CX 81	2118•
ZX 36	922	AX 35	919			BX 37	965			CX 85	2217•
ZX 37	947	AX 35 ^{1/2}	930			BX 38	1005			CX 88	2298•
ZX 38	972	AX 36	944			BX 39	1040				
ZX 40	1038•	AX 37	955			BX 40	1056			BM BQ = 5 St. pieces	
ZX 42	1082•	AX 37 ^{1/2}	980			BX 41	1080			CX 90	2344•
ZX 46 ^{1/2}	1202•	AX 38	995			BX 42	1100			CX 93	2418•
ZX 52	1342•	AX 39	1030			BX 43	1130			CX 96	2496•
ZX 55	1422•	AX 40	1046			BX 44	1160			CX 98	2558•
ZX 59	1522•	AX 41 ^{1/2}	1080			BX 45	1190			CX 110	2858•
		AX 42	1090			BX 45 ^{1/2}	1203			CX 118	3058•
		AX 43	1130			BX 46	1215			CX 124	3208•
		AX 44	1150			BX 46 ^{1/2}	1220			CX 132	3408•
		AX 45 ^{1/2}	1180			BX 47	1240				
		AX 46	1198			BX 48	1255				
		AX 47	1230			BX 49	1290				
		AX 48	1250			BX 50	1315				
		AX 49	1280			BX 51	1340				
		AX 50	1300			BX 52	1360				
		AX 51	1330			BX 53	1390				
		AX 52	1350			BX 54	1412				
		AX 53	1380			BX 55	1440				
		AX 54	1405			BX 57	1490				
		AX 55	1430			BX 58	1513				
		AX 56	1452			BX 59	1540				
		AX 57	1480			BX 61	1590				
		AX 58	1505			BX 62	1615				
		AX 59	1530			BX 63	1640				
		AX 62	1605			BX 67	1740				
		AX 63	1630			BX 69	1790				
		AX 67	1730			BX 71	1840				
		AX 70	1805			BX 73	1890				
		AX 71	1830			BX 75	1940				
		AX 75	1930								
		AX 79	2030								
		AX 88	2270								
Gewicht Belt weight: ≈ 0,062 kg/m L _i ≈ L _d - 22 mm		Gewicht Belt weight: ≈ 0,099 kg/m L _i ≈ L _d - 30 mm				Gewicht Belt weight: ≈ 0,165 kg/m L _i ≈ L _d - 40 mm				Gewicht Belt weight: ≈ 0,276 kg/m L _i ≈ L _d - 58 mm	

Alle Keilriemen der Ausführung Optibelt Super TX M=S können bei gleicher Nennlänge ungemessen zu Sätzen vereinigt werden.
 Optibelt Super TX M=S V-belts of the same length can be used in matched sets, without the need for re-measuring and matching.

L_i = Innenlänge Inside length

Richtlänge Datum length L_d = Wirklänge Pitch length L_w/L_p

• Keine Lagerware. Mindest-Abnahmemenge auf Anfrage.

• Non stock items. Minimum production quantity on request.



Standard-Fertigungsdaten *Manufacturing data*

Riemenlänge <i>Belt length</i>	bis up to 5000 mm L_i
Obere Riemenbreite <i>Belt top width</i>	bis up to 100 mm
Riemenhöhe <i>Belt height</i>	5 bis up to 30 mm
24°-Winkel für Profile <i>angle for sections</i>	13 x 5; 17 x 5
30°-Winkel für Profile <i>angle for sections</i>	52 x 16; 55 x 16; 65 x 20; 70 x 18
<p>27°-Winkel für alle anderen Profile. Abmessungen nach USA-Standard RMA/MPTA sowie Breitkeilriemen mit Winkel von 22° bis 42° können auf Anfrage gefertigt werden. Mindest-Abnahmemengen sind erforderlich. <i>27° angle for all other sections except range to USA Standard RMA/MPTA. Variable speed belts with angles of 22° to 42° can be made on request, but minimum quantities are obligatory.</i></p>	

Toleranzen *Tolerances*

Längentoleranz <i>Length tolerance</i>	$\pm 1\%$ der Riemen-Nennlänge <i>of nominal belt length</i>
Winkeltoleranz <i>Angle tolerance</i>	$\pm 1,5^\circ$ vom Nennwinkel <i>of nominal angle</i>
Höhentoleranz <i>Height tolerance</i>	≤ 8 mm = $\pm 0,8$ mm > 8 bis up to 20 mm = $\pm 1,0$ mm > 20 mm = $\pm 1,5$ mm
Breitentoleranz <i>Width tolerance</i>	$\pm 0,75$ mm

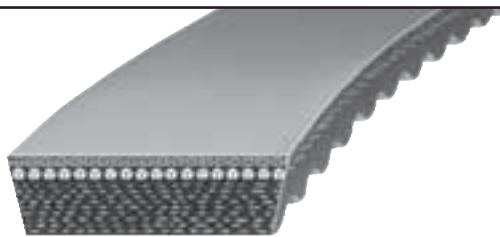

Profil Section (mm)	Innenlänge Inside length (mm)	ISO-Bezeichnung ISO Designation (Pitch length mm)
13 x 5	468	
13 x 5	500	
17 x 5	426	W 16 450
17 x 5	476	W 16 500
17 x 5	536	W 16 560
17 x 5	570	W 16 600
17 x 5	606	W 16 630
17 x 5	776	W 16 800
21 x 6	530	W 20 560
21 x 6	600	W 20 630
21 x 6	610	W 20 640
21 x 6	675	W 20 710
21 x 6	770	W 20 800
21 x 6	870	W 20 900
21 x 6	970	W 20 1000
21 x 6	1220	W 20 1250
22 x 8	485	
22 x 8	525	
22 x 8	565	
22 x 8	650	
22 x 8	700	
22 x 8	750	
22 x 8	800	
22 x 8	850	
22 x 8	900	
22 x 8	950	
22 x 8	1000	
22 x 8	1060	
22 x 8	1185	
26 x 8	655	W 25 690
26 x 8	672	W 25 710
26 x 8	710	W 25 750
26 x 8	750	W 25 790
26 x 8	762	W 25 800
26 x 8	800	W 25 840
26 x 8	862	W 25 900
26 x 8	962	W 25 1000
26 x 8	1082	W 25 1120
28 x 8	600	
28 x 8	650	
28 x 8	700	
28 x 8	750	
28 x 8	800	
28 x 8	850	
28 x 8	900	
28 x 8	950	
28 x 8	1000	
28 x 8	1060	
28 x 8	1120	
28 x 8	1180	
28 x 8	1250	
28 x 8	1320	
28 x 8	1400	
28 x 8	1500	

Profil Section (mm)	Innenlänge Inside length (mm)	ISO-Bezeichnung ISO Designation (Pitch length mm)
30 x 10	650	
30 x 10	665	
30 x 10	700	
30 x 10	800	
30 x 10	850	
30 x 10	875	
30 x 10	900	
30 x 10	950	
30 x 10	1000	
30 x 10	1035	
30 x 10	1120	
30 x 10	1200	
30 x 10	1340	
30 x 10	1500	
30 x 10	1600	
32 x 10	750	W 31.5 800
32 x 10	790	W 31.5 840
32 x 10	820	W 31.5 870
32 x 10	850	W 31.5 900
32 x 10	900	W 31.5 950
32 x 10	950	W 31.5 1000
32 x 10	1000	W 31.5 1050
32 x 10	1073	W 31.5 1120
32 x 10	1120	W 31.5 1170
32 x 10	1180	W 31.5 1230
32 x 10	1200	W 31.5 1250
32 x 10	1353	W 31.5 1400
37 x 10	660	
37 x 10	800	
37 x 10	850	
37 x 10	900	
37 x 10	950	
37 x 10	1000	
37 x 10	1020	
37 x 10	1060	
37 x 10	1120	
37 x 10	1180	
37 x 10	1250	
37 x 10	1320	
37 x 10	1400	
37 x 10	1500	
37 x 10	1600	
37 x 10	1700	
37 x 10	1800	
41 x 13	925	W 40 990
41 x 13	1000	W 40 1060
41 x 13	1040	W 40 1100
41 x 13	1060	W 40 1120
41 x 13	1120	W 40 1180
41 x 13	1180	W 40 1240
41 x 13	1190	W 40 1250
41 x 13	1250	W 40 1310
41 x 13	1340	W 40 1400
41 x 13	1440	W 40 1500
41 x 13	1600	W 40 1660
41 x 13	1740	W 40 1800
41 x 13	1940	W 40 2000

Profil Section (mm)	Innenlänge Inside length (mm)	ISO-Bezeichnung ISO Designation (Pitch length mm)
47 x 13	1000	
47 x 13	1060	
47 x 13	1120	
47 x 13	1180	
47 x 13	1250	
47 x 13	1320	
47 x 13	1400	
47 x 13	1500	
47 x 13	1600	
47 x 13	1700	
47 x 13	1800	
52 x 16	1180	W 50 1250
52 x 16	1250	W 50 1320
52 x 16	1325	W 50 1400
52 x 16	1400	W 50 1480
52 x 16	1525	W 50 1600
52 x 16	1600	W 50 1680
52 x 16	1725	W 50 1800
52 x 16	1925	W 50 2000
52 x 16	2165	W 50 2240
52 x 16	2240	W 50 2320
55 x 16	1400	
55 x 16	1500	
55 x 16	1600	
55 x 16	1700	
55 x 16	1800	
65 x 20	1706	W 63 1800
65 x 20	1906	W 63 2000
70 x 18	1600	
70 x 18	1700	
70 x 18	1800	
70 x 18	1900	
70 x 18	2000	
70 x 18	2240	
70 x 18	2500	

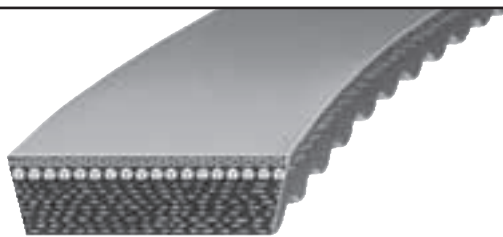

RMA/MPTA- Bezeichnung Designation	RMA/MPTA- Bezeichnung Designation	RMA/MPTA- Bezeichnung Designation	RMA/MPTA- Bezeichnung Designation
1422 V 235•	2322 V 329•	3226 V 392•	4436 V 525•
1422 V 240•	2322 V 347•	3226 V 400•	4436 V 551•
1422 V 270•	2322 V 364•	3226 V 433•	4436 V 561•
1422 V 290•	2322 V 396•	3226 V 450•	4436 V 576•
1422 V 300•	2322 V 421•	3226 V 505•	4436 V 646•
1422 V 330•	2322 V 434•	3226 V 545•	4436 V 750•
1422 V 340•	2322 V 441•	3226 V 585•	
1422 V 360•	2322 V 461•	3226 V 603•	
1422 V 400•	2322 V 481•	3226 V 650•	
1422 V 420•	2322 V 486•	3226 V 663•	
1422 V 440•	2322 V 521•	3226 V 723•	
1422 V 460•	2322 V 541•	3226 V 783•	
1422 V 470•	2322 V 601•	3226 V 843•	
1422 V 480•	2322 V 661•		
1422 V 540•	2322 V 681•	3230 V 419•	
1422 V 600•	2322 V 701•	3230 V 528•	
1422 V 660•	2322 V 801•	3230 V 560•	
		3230 V 585•	
1430 V 215•	2426 V 353•	3230 V 600•	
	2426 V 363•	3230 V 630•	
1922 V 277•		3230 V 670•	
1922 V 282•	2530 V 500•	3230 V 710•	
1922 V 298•	2530 V 530•	3230 V 723•	
1922 V 321•	2530 V 560•	3230 V 750•	
1922 V 332•	2530 V 600•	3230 V 800•	
1922 V 338•	2530 V 630•	3230 V 850•	
1922 V 363•	2530 V 670•		
1922 V 381•	2530 V 710•	3432 V 450•	
1922 V 386•	2530 V 750•	3432 V 456•	
1922 V 403•	2530 V 790•	3432 V 480•	
1922 V 426•	2530 V 800•	3432 V 528•	
1922 V 443•	2530 V 934•	3432 V 534•	
1922 V 454•	2530 V 990•		
1922 V 460•		4036 V 541•	
1922 V 484•	2830 V 337•	4036 V 574•	
1922 V 526•	2830 V 363•		
1922 V 544•	2830 V 366•	4430 V 530•	
1922 V 604•	2830 V 367•	4430 V 548•	
1922 V 630•	2830 V 393•	4430 V 555•	
1922 V 646•	2830 V 396•	4430 V 560•	
1922 V 666•	2830 V 422•	4430 V 570•	
1922 V 686•		4430 V 578•	
1922 V 706•	2926 V 471•	4430 V 600•	
1922 V 721•	2926 V 486•	4430 V 610•	
1922 V 726•	2926 V 521•	4430 V 630•	
1922 V 751•	2926 V 546•	4430 V 652•	
1922 V 756•	2926 V 574•	4430 V 660•	
	2926 V 586•	4430 V 670•	
1926 V 250•	2926 V 606•	4430 V 690•	
1926 V 275•	2926 V 616•	4430 V 700•	
1926 V 290•	2926 V 636•	4430 V 710•	
1926 V 407•	2926 V 646•	4430 V 730•	
1926 V 415•	2926 V 666•	4430 V 750•	
1926 V 427•	2926 V 686•	4430 V 790•	
	2926 V 726•	4430 V 800•	
2230 V 266•	2926 V 750•	4430 V 850•	
2230 V 273•	2926 V 776•		
2230 V 275•	2926 V 786•		
2230 V 326•			
2230 V 375•			

Erklärung Interpretation
 1422 V 235
 14 = obere Breite top width 14/16"
 22 = Winkel pulley angle degrees
 V = Variable Speed Variable Speed
 235 = Wirklänge in pitch length in 1/10"

• Keine Lagerware, Mindestabnahmemenge auf Anfrage. • Non stock items, minimum quantity on request.

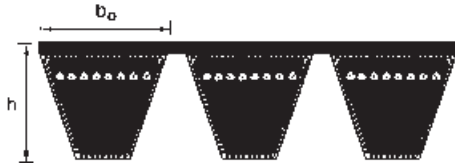

Profil Sect.	SPZ	SPA	SPB	SPC
$b_0 \approx$ (mm)	9,7	12,7	16,5	22,0
$h \approx$ (mm)	10,5	12,5	15,6	22,6

Profil Section SPZ	Profil Section SPA	Profil Section SPB	Profil Section SPC
Richtlänge Datum length ISO (mm)	Richtlänge Datum length ISO (mm)	Richtlänge Datum length ISO (mm)	Richtlänge Datum length ISO (mm)
1250 1400 1500 1600 1700 1800 1900 2000 2120 2240 2360 2500 2650 2800 3000 3150 3350 3550	1250 1400 1500 1600 1700 1800 1900 2000 2120 2240 2360 2500 2650 2800 3000 3150 3350 3550 3750 4000 4250 4500	2000 2120 2240 2360 2500 2650 2800 3000 3150 3350 3550 3750 4000 4250 4500 4750 5000 5300 5600 6000 6300 6700 7100 7500 8000	3000 3150 3350 3550 3750 4000 4250 4500 4750 5000 5300 5600 6000 6300 6700 7100 7500 8000 8500 9000 9500 10000 10600 11200 11800 12500
Anfertigungsware Non stock items			
<p>Weitere Abmessungen auf Anfrage. Optibelt KB der Profile SPZ, SPA, SPB und SPC können in Standard-Keilrillenscheiben gemäß DIN 2211 und ISO 4183 eingesetzt werden. Further sizes on request. Optibelt kraftbands in sections SPZ, SPA, SPB and SPC will run in standard pulleys to BS 3790, DIN 2211 and ISO 4183.</p> <p>Flankenoffene, formgezahnte Kraftbänder – Profile XPZ, XPA, XPB und XPC auf Anfrage. Moulded cogged, raw edge kraftbands with XPZ, XPA, XPB and XPC belts are available on request.</p>			

<p>Maximale Fertigungslänge <i>Maximum manufacturing length</i>: 4500 mm L_d Zwischenlängen ab <i>Intermediate lengths from</i> 1800 mm L_d</p> <p>Mindest-Abnahmemenge für Sonderlängen <i>Minimum quantities for non-listed sizes</i>: 1800 bis up to ≤ 2050 mm L_d 8 Stück <i>pieces</i> à with 5 Rippen <i>ribs</i> oder or 10 Stück <i>pieces</i> à with 4 Rippen <i>ribs</i> oder or 14 Stück <i>pieces</i> à with 3 Rippen <i>ribs</i> oder or 21 Stück <i>pieces</i> à with 2 Rippen <i>ribs</i> oder ein Vielfaches hiervon or <i>multiples thereof</i> > 2050 mm L_d 7 Stück <i>pieces</i> à with 5 Rippen <i>ribs</i> oder or 9 Stück <i>pieces</i> à with 4 Rippen <i>ribs</i> oder or 12 Stück <i>pieces</i> à with 3 Rippen <i>ribs</i> oder or 18 Stück <i>pieces</i> à with 2 Rippen <i>ribs</i> oder ein Vielfaches hiervon or <i>multiples thereof</i></p> <p>Gewicht <i>Belt weight</i>: 1 Rippe <i>rib</i> $\approx 0,120$ kg/m</p> <p>Mindest-Abnahmemenge für Aramid-Konstruktionen auf Anfrage. <i>Minimum order quantities for Aramid constructions on request.</i></p>	<p>Maximale Fertigungslänge <i>Maximum manufacturing length</i>: 4500 mm L_d Zwischenlängen ab <i>Intermediate lengths from</i> 1800 mm L_d</p> <p>Mindest-Abnahmemenge für Sonderlängen <i>Minimum quantities for non-listed sizes</i>: 1800 bis up to ≤ 2050 mm L_d 6 Stück <i>pieces</i> à with 5 Rippen <i>ribs</i> oder or 8 Stück <i>pieces</i> à with 4 Rippen <i>ribs</i> oder or 11 Stück <i>pieces</i> à with 3 Rippen <i>ribs</i> oder or 16 Stück <i>pieces</i> à with 2 Rippen <i>ribs</i> oder ein Vielfaches hiervon or <i>multiples thereof</i> > 2050 mm L_d 5 Stück <i>pieces</i> à with 5 Rippen <i>ribs</i> oder or 7 Stück <i>pieces</i> à with 4 Rippen <i>ribs</i> oder or 9 Stück <i>pieces</i> à with 3 Rippen <i>ribs</i> oder or 14 Stück <i>pieces</i> à with 2 Rippen <i>ribs</i> oder ein Vielfaches hiervon or <i>multiples thereof</i></p> <p>Gewicht <i>Belt weight</i>: 1 Rippe <i>rib</i> $\approx 0,166$ kg/m</p> <p>Mindest-Abnahmemenge für Aramid-Konstruktionen auf Anfrage. <i>Minimum order quantities for Aramid constructions on request.</i></p>	<p>Maximale Fertigungslänge <i>Maximum manufacturing length</i>: 10000 mm L_d Zwischenlängen ab <i>Intermediate lengths from</i> 2000 L_d</p> <p>Mindest-Abnahmemenge für Sonderlängen <i>Minimum quantities for non-listed sizes</i>: 4 Stück <i>pieces</i> à with 5 Rippen <i>ribs</i> oder or 5 Stück <i>pieces</i> à with 4 Rippen <i>ribs</i> oder or 7 Stück <i>pieces</i> à with 3 Rippen <i>ribs</i> oder or 11 Stück <i>pieces</i> à with 2 Rippen <i>ribs</i> oder ein Vielfaches hiervon or <i>multiples thereof</i></p> <p>Gewicht <i>Belt weight</i>: 1 Rippe <i>rib</i> $\approx 0,261$ kg/m</p> <p>Mindest-Abnahmemenge für Aramid-Konstruktionen auf Anfrage. <i>Minimum order quantities for Aramid constructions on request.</i></p>	<p>Maximale Fertigungslänge <i>Maximum manufacturing length</i>: 12500 mm L_d Zwischenlängen ab <i>Intermediate lengths from</i> 2120 mm L_d</p> <p>Mindest-Abnahmemenge für Sonderlängen <i>Minimum quantities for non-listed sizes</i>: 3 Stück <i>pieces</i> à with 5 Rippen <i>ribs</i> oder or 4 Stück <i>pieces</i> à with 4 Rippen <i>ribs</i> oder or 5 Stück <i>pieces</i> à with 3 Rippen <i>ribs</i> oder or 8 Stück <i>pieces</i> à with 2 Rippen <i>ribs</i> oder ein Vielfaches hiervon or <i>multiples thereof</i></p> <p>Gewicht <i>Belt weight</i>: 1 Rippe <i>rib</i> $\approx 0,555$ kg/m</p> <p>Mindest-Abnahmemenge für Aramid-Konstruktionen auf Anfrage. <i>Minimum order quantities for Aramid constructions on request.</i></p>
--	--	---	---

Richtlänge Datum length L_d = Wirklänge Pitch length L_w/L_p

Kraftbänder mit Auflage siehe Seite 30. Kraftbands with special top surfaces see page 30.

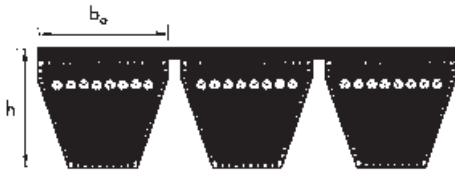

Profil Sect.	3V/9J	5V/15J	8V/25J
$b_o \approx$ (mm)	9,0	15,0	25,0
$h \approx$ (mm)	9,9	15,1	25,5

Profil Section 3V/9J		Profil Section 5V/15J		Profil Section 8V/25J	
Riemenbezeichnung Belt no.		Riemenbezeichnung Belt no.		Riemenbezeichnung Belt no.	
(Zoll inch)	Metric reference (Außenlänge Effective outside length mm)	(Zoll inch)	Metric reference (Außenlänge Effective outside length mm)	(Zoll inch)	Metric reference (Außenlänge Effective outside length mm)
3V 500	9J 1270	5V 560	15J 1422	8V 1000	25J 2540
3V 530	9J 1346	5V 600	15J 1524	8V 1060	25J 2692
3V 560	9J 1422	5V 630	15J 1600	8V 1120	25J 2845
3V 600	9J 1524	5V 670	15J 1702	8V 1180	25J 2997
3V 630	9J 1600	5V 710	15J 1803	8V 1250	25J 3175
3V 670	9J 1702	5V 750	15J 1905	8V 1320	25J 3353
3V 710	9J 1803	5V 800	15J 2032	8V 1400	25J 3556
3V 750	9J 1905	5V 850	15J 2159	8V 1500	25J 3810
3V 800	9J 2032	5V 900	15J 2286	8V 1600	25J 4064
3V 850	9J 2159	5V 950	15J 2413	8V 1700	25J 4318
3V 900	9J 2286	5V 1000	15J 2540	8V 1800	25J 4572
3V 950	9J 2413	5V 1060	15J 2692	8V 1900	25J 4826
3V 1000	9J 2540	5V 1120	15J 2845	8V 2000	25J 5080
3V 1060	9J 2692	5V 1180	15J 2997	8V 2120	25J 5385
3V 1120	9J 2845	5V 1250	15J 3175	8V 2240	25J 5690
3V 1180	9J 2997	5V 1320	15J 3353	8V 2360	25J 5994
3V 1250	9J 3175	5V 1400	15J 3556	8V 2500	25J 6350
3V 1320	9J 3353	5V 1500	15J 3810	8V 2650	25J 6731
3V 1400	9J 3556	5V 1600	15J 4064	8V 2800	25J 7112
		5V 1700	15J 4318	8V 3000	25J 7620
		5V 1800	15J 4572	8V 3150	25J 8001
		5V 1900	15J 4826	8V 3350	25J 8509
		5V 2000	15J 5080	8V 3550	25J 9017
		5V 2120	15J 5385	8V 3750	25J 9525
		5V 2240	15J 5690	8V 4000	25J 10160
		5V 2360	15J 5994	8V 4250	25J 10795
		5V 2500	15J 6350	8V 4500	25J 11430
		5V 2650	15J 6731	8V 4750	25J 12065
		5V 2800	15J 7112		
		5V 3000	15J 7620		
		5V 3150	15J 8001		
		5V 3350	15J 8509		
		5V 3550	15J 9017		

Weitere Abmessungen auf Anfrage
 Further sizes on request

Maximale Fertigungslänge
 Maximum manufacturing length: 4250 mm L_a
 Zwischenlängen ab *Intermediate lengths from* 1800 mm L_a

Mindest-Abnahmemenge für Sonderlängen
Minimum quantities for non-listed sizes:

9 Stück *pieces à with* 5 Rippen *ribs* oder oder
 12 Stück *pieces à with* 4 Rippen *ribs* oder oder
 16 Stück *pieces à with* 3 Rippen *ribs* oder oder
 24 Stück *pieces à with* 2 Rippen *ribs*
 oder ein Vielfaches hiervon *or multiples thereof*

Gewicht *Belt weight*: 1 Rippe *rib* \approx 0,122 kg/m

Mindest-Abnahmemenge für Aramid-Konstruktionen auf Anfrage. Minimum order quantities for Aramid constructions on request.

Maximale Fertigungslänge
 Maximum manufacturing length: 10 000 mm L_a
 Zwischenlängen ab *Intermediate lengths from* 1800 mm L_a

Mindest-Abnahmemenge für Sonderlängen
Minimum quantities for non-listed sizes:

6 Stück *pieces à with* 5 Rippen *ribs* oder oder
 7 Stück *pieces à with* 4 Rippen *ribs* oder oder
 10 Stück *pieces à with* 3 Rippen *ribs* oder oder
 15 Stück *pieces à with* 2 Rippen *ribs*
 oder ein Vielfaches hiervon *or multiples thereof*

Gewicht *Belt weight*: 1 Rippe *rib* \approx 0,252 kg/m

Mindest-Abnahmemenge für Aramid-Konstruktionen auf Anfrage. Minimum order quantities for Aramid constructions on request.

Maximale Standard-Fertigungslänge
 Maximum standard manufacturing length: 15 000 mm L_a
 Über *Above* 15 000 bis *up to* 18 000 mm auf Anfrage
on request

Zwischenlängen ab *Intermediate lengths from* 2540 mm L_a

Mindest-Abnahmemenge für Sonderlängen
Minimum quantities for non-listed sizes:

2 Stück *pieces à with* 5 Rippen *ribs* oder oder
 2 Stück *pieces à with* 4 Rippen *ribs* oder oder
 3 Stück *pieces à with* 3 Rippen *ribs*
 oder ein Vielfaches hiervon *or multiples thereof*

Gewicht *Belt weight*: 1 Rippe *rib* \approx 0,693 kg/m

Mindest-Abnahmemenge für Aramid-Konstruktionen auf Anfrage. Minimum order quantities for Aramid constructions on request.

wartungsfrei
service-free

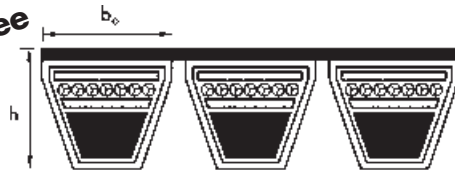

Profil Sect.	SPB	SPC
$b_0 \approx$ (mm)	16,5	22,0
$h \approx$ (mm)	15,6	22,6

Profil Section SPB	Profil Section SPC
Richtlänge Datum length ISO (mm)	Richtlänge Datum length ISO (mm)
2000 2120 2240 2360 2500 2650 2800 3000 3150 3350 3550 3750 4000 4250 4500 4750 5000 5300 5600 6000 6300 6700 7100 7500 8000	3000 3150 3350 3550 3750 4000 4250 4500 4750 5000 5300 5600 6000 6300 6700 7100 7500 8000 8500 9000 9500 10000

Profil SPA und SPZ auf Anfrage
Section SPA and SPZ on request

Anfertigungsware Non stock items

Optibelt KB der Profile SPB und SPC können in Standard-Keilrillenscheiben gemäß DIN 2211 und ISO 4183 eingesetzt werden. Weitere Abmessungen auf Anfrage.
 Optibelt kraftbands in sections SPB and SPC will run in standard pulleys to BS 3790, DIN 2211 and ISO 4183. Further sizes on request.

Maximale Fertigungslänge Maximum manufacturing length: 8000 mm L_d Zwischenlängen ab Intermediate lengths from 2000 mm L_d Mindest-Abnahmemenge für alle Abmessungen Minimum quantities for all sizes: 2000 bis up to 4000 mm L_d 10 Stück pieces à with 5 Rippen ribs oder or 12 Stück pieces à with 4 Rippen ribs oder or 18 Stück pieces à with 3 Rippen ribs oder or 26 Stück pieces à with 2 Rippen ribs oder ein Vielfaches hiervon or multiples thereof über over 4000 mm L_d 5 Stück pieces à with 5 Rippen ribs oder or 6 Stück pieces à with 4 Rippen ribs oder or 9 Stück pieces à with 3 Rippen ribs oder or 13 Stück pieces à with 2 Rippen ribs oder ein Vielfaches hiervon or multiples thereof Gewicht Belt weight: 1 Rippe rib \approx 0,261 kg/m	Maximale Fertigungslänge Maximum manufacturing length: 10000 mm L_d Zwischenlängen ab Intermediate lengths from 3000 mm L_d Mindest-Abnahmemenge für alle Abmessungen Minimum quantities for all sizes: 4 Stück pieces à with 5 Rippen ribs oder or 5 Stück pieces à with 4 Rippen ribs oder or 6 Stück pieces à with 3 Rippen ribs oder or 10 Stück pieces à with 2 Rippen ribs oder ein Vielfaches hiervon or multiples thereof Gewicht Belt weight: 1 Rippe rib \approx 0,555 kg/m
--	---

Richtlänge Datum length L_d = Wirklänge Pitch length L_w/L_p

wartungsfrei
service-free

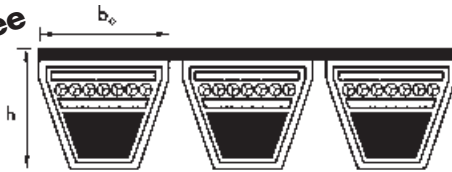

Profil Sect.	3V/9J	5V/15J	8V/25J
$b_o \approx$ (mm)	9,0	15,0	25,0
$h \approx$ (mm)	9,9	15,1	25,5

Profil Section 3V/9J		Profil Section 5V/15J		Profil Section 8V/25J	
Riemenbezeichnung Belt no.		Riemenbezeichnung Belt no.		Riemenbezeichnung Belt no.	
(Zoll inch)	Metric reference (Außenlänge Outside length mm)	(Zoll inch)	Metric reference (Außenlänge Outside length mm)	(Zoll inch)	Metric reference (Außenlänge Outside length mm)
3V 500	9J 1270	5V 560	15J 1422	8V 1000	25J 2540
3V 530	9J 1346	5V 600	15J 1524	8V 1060	25J 2692
3V 560	9J 1422	5V 630	15J 1600	8V 1120	25J 2845
3V 600	9J 1524	5V 670	15J 1702	8V 1180	25J 2997
3V 630	9J 1600	5V 710	15J 1803	8V 1250	25J 3175
3V 670	9J 1702	5V 750	15J 1905	8V 1320	25J 3353
3V 710	9J 1803	5V 800	15J 2032	8V 1400	25J 3556
3V 750	9J 1905	5V 850	15J 2159	8V 1500	25J 3810
3V 800	9J 2032	5V 900	15J 2286	8V 1600	25J 4064
3V 850	9J 2159	5V 950	15J 2413	8V 1700	25J 4318
3V 900	9J 2286	5V 1000	15J 2540	8V 1800	25J 4572
3V 950	9J 2413	5V 1060	15J 2692	8V 1900	25J 4826
3V 1000	9J 2540	5V 1120	15J 2845	8V 2000	25J 5080
3V 1060	9J 2692	5V 1180	15J 2997	8V 2120	25J 5385
3V 1120	9J 2845	5V 1250	15J 3175	8V 2240	25J 5690
3V 1180	9J 2997	5V 1320	15J 3353	8V 2360	25J 5994
3V 1250	9J 3175	5V 1400	15J 3556	8V 2500	25J 6350
3V 1320	9J 3353	5V 1500	15J 3810	8V 2650	25J 6731
3V 1400	9J 3556	5V 1600	15J 4064	8V 2800	25J 7112
		5V 1700	15J 4318	8V 3000	25J 7620
		5V 1800	15J 4572	8V 3150	25J 8001
		5V 1900	15J 4826	8V 3350	25J 8509
		5V 2000	15J 5080	8V 3550	25J 9017
		5V 2120	15J 5385	8V 3750	25J 9525
		5V 2240	15J 5690	8V 4000	25J 10160
		5V 2360	15J 5994	8V 4250	25J 10795
		5V 2500	15J 6350	8V 4500	25J 11430
		5V 2650	15J 6731	8V 4750	25J 12065
		5V 2800	15J 7112		
		5V 3000	15J 7620		
		5V 3150	15J 8001		

Anfertigungsware Non stock items

Weitere Abmessungen auf Anfrage.
 Further sizes on request.

<p>Maximale Fertigungslänge Maximum manufacturing length: 4000 mm L_a Zwischenlängen ab Intermediate lengths from 1270 mm L_a Mindest-Abnahmemenge für Sonderlängen Minimum quantities for non-listed sizes: 1270 bis up to 2032 mm L_a 19 Stück pieces à with 5 Rippen ribs oder or 24 Stück pieces à with 4 Rippen ribs oder or 32 Stück pieces à with 3 Rippen ribs oder or 48 Stück pieces à with 2 Rippen ribs oder ein Vielfaches hiervon or multiples thereof über over 2032 mm L_a 23 Stück pieces à with 5 Rippen ribs oder or 29 Stück pieces à with 4 Rippen ribs oder or 38 Stück pieces à with 3 Rippen ribs oder or 58 Stück pieces à with 2 Rippen ribs oder ein Vielfaches hiervon or multiples thereof</p> <p>Gewicht Belt weight: 1 Rippe rib \approx 0,122 kg/m</p>	<p>Maximale Fertigungslänge Maximum manufacturing length: 9525 mm L_a Zwischenlängen ab Intermediate lengths from 1422 mm L_a Mindest-Abnahmemenge für Sonderlängen Minimum quantities for non-listed sizes: 1270 bis up to 2032 mm L_a 12 Stück pieces à with 5 Rippen ribs oder or 15 Stück pieces à with 4 Rippen ribs oder or 20 Stück pieces à with 3 Rippen ribs oder or 30 Stück pieces à with 2 Rippen ribs oder ein Vielfaches hiervon or multiples thereof über over 2032 mm L_a bis to 4000 mm L_a 13 Stück pieces à with 5 Rippen ribs oder or 16 Stück pieces à with 4 Rippen ribs oder or 22 Stück pieces à with 3 Rippen ribs oder or 33 Stück pieces à with 2 Rippen ribs oder ein Vielfaches hiervon or multiples thereof über over 4000 mm L_a 6 Stück pieces à with 5 Rippen ribs oder or 7 Stück pieces à with 4 Rippen ribs oder or 10 Stück pieces à with 3 Rippen ribs oder or 15 Stück pieces à with 2 Rippen ribs oder ein Vielfaches hiervon or multiples thereof</p> <p>Gewicht Belt weight: 1 Rippe rib \approx 0,252 kg/m</p>	<p>Maximale Fertigungslänge Maximum manufacturing length: 12065 mm L_a Zwischenlängen ab Intermediate lengths from 2540 mm L_a Mindest-Abnahmemenge für alle Abmessungen Minimum quantities for all sizes: 2 Stück pieces à with 5 Rippen ribs oder or 2 Stück pieces à with 4 Rippen ribs oder or 3 Stück pieces à with 3 Rippen ribs oder or 5 Stück pieces à with 2 Rippen ribs oder ein Vielfaches hiervon or multiples thereof</p> <p>Gewicht Belt weight: 1 Rippe rib \approx 0,693 kg/m</p>
--	---	--

Richtlänge Datum length L_d = Wirklänge Pitch length L_w/L_p

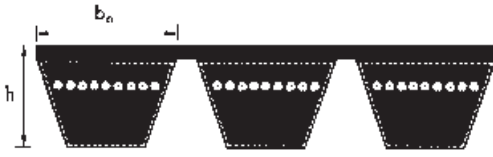

Profil Sect.	A/HA	B/HB	C/HC	D/HD
$b_o \approx$ (mm)	13,0	17,0	22,0	32,0
$h \approx$ (mm)	9,9	13,0	16,2	22,4

Profil Section A/HA			Profil Section B/HB			Profil Section C/HC			Profil Section D/HD		
Profil Section A		Profil Sect. HA	Profil Section B		Profil Sect. HB	Profil Section C		Profil Sect. HC	Profil Section D		Profil Sect. HD
Riemen-Nr. Belt no.	Innenlänge Inside length (mm)	Außenlänge Outside length (mm)	Riemen-Nr. Belt no.	Innenlänge Inside length (mm)	Außenlänge Outside length (mm)	Riemen-Nr. Belt no.	Innenlänge Inside length (mm)	Außenlänge Outside length (mm)	Riemen-Nr. Belt no.	Innenlänge Inside length (mm)	Außenlänge Outside length (mm)
A 47	1200	1236	B 47	1200	1262	C 90	2286	2361	D 98	2500	2611
A 51	1300	1336	B 51	1300	1362	C 98	2500	2575	D 110	2800	2911
A 56	1422	1458	B 55	1400	1462	C 108	2750	2825	D 120	3048	3159
A 57	1450	1486	B 59	1500	1562	C 120	3048	3123	D 128	3250	3361
A 59	1500	1536	B 61	1550	1612	C 128	3250	3325	D 144	3658	3769
A 64	1625	1661	B 63	1600	1662	C 140	3550	3625	D 158	4000	4111
A 67	1700	1736	B 64	1625	1687	C 146	3700	3775	D 162	4115	4226
A 71	1800	1836	B 67	1700	1762	C 151	3850	3925	D 173	4394	4505
A 75	1900	1936	B 71	1800	1862	C 167	4250	4325	D 180	4572	4683
A 79	2000	2036	B 73	1850	1912	C 177	4500	4575	D 195	4953	5064
A 88	2240	2276	B 75	1900	1962	C 187	4750	4825	D 210	5334	5445
A 98	2500	2536	B 79	2000	2062	C 197	5000	5075	D 225	5715	5826
A 100	2540	2576	B 83	2100	2162	C 208	5300	5375	D 240	6096	6207
A 104	2650	2686	B 88	2240	2302	C 220	5600	5675	D 255	6477	6588
A 112	2845	2881	B 91	2300	2362	C 236	6000	6075	D 270	6858	6969
A 120	3048	3084	B 94 ^{1/2}	2400	2462	C 248	6300	6375	D 285	7239	7350
A 128	3250	3286	B 98	2500	2562				D 300	7620	7731
A 144	3658	3694	B 102	2600	2662				D 315	8000	8111
A 158	4000	4036	B 106	2700	2762				D 330	8382	8493
A 167	4250	4286	B 112	2845	2907				D 345	8763	8874
A 187	4750	4786	B 118	3000	3062				D 360	9144	9255
			B 120	3048	3110				D 390	9906	10017
			B 128	3250	3312				D 420	10668	10779
			B 132	3350	3412				D 450	11430	11541
			B 140	3550	3612				D 480	12200	12311
			B 146	3700	3762				D 540	13716	13827
			B 148	3750	3812				D 600	15240	15351
			B 158	4000	4062				D 660	16764	16875
			B 167	4250	4312				D 700	17780	17891
			B 177	4500	4562						
			B 187	4750	4812						
			B 197	5000	5062						
			B 208	5300	5362						
			B 220	5600	5662						

**Anfertigungsware
 Non stock items**

**Flankenoffene, formgezahnte Kraftbänder Profil AX/HAX, BX/HBX und CX/HCX auf Anfrage.
 Moulded cogged, raw edge kraftbands section AX/HAX, BX/HBX and CX/HCX on request.
 Weitere Abmessungen auf Anfrage. Further sizes on request.**

<p>Maximale Fertigungslänge <i>Maximum manufacturing length:</i> 8000 mm L_1 Zwischenlängen ab <i>Intermediate lengths from</i> 1800 mm L_1</p> <p>Mindest-Abnahmemenge für Sonderlängen <i>Minimum quantities for non-listed sizes:</i> 1200 bis up to 2000 mm L_1 6 Stück <i>pieces</i> à with 5 Rippen <i>ribs</i> oder or 8 Stück <i>pieces</i> à with 4 Rippen <i>ribs</i> oder or 10 Stück <i>pieces</i> à with 3 Rippen <i>ribs</i> oder or 16 Stück <i>pieces</i> à with 2 Rippen <i>ribs</i> oder ein Vielfaches hiervon or multiples thereof</p> <p>2001 bis up to 8000 mm L_1 6 Stück <i>pieces</i> à with 5 Rippen <i>ribs</i> oder or 8 Stück <i>pieces</i> à with 4 Rippen <i>ribs</i> oder or 11 Stück <i>pieces</i> à with 3 Rippen <i>ribs</i> oder or 16 Stück <i>pieces</i> à with 2 Rippen <i>ribs</i> oder ein Vielfaches hiervon or multiples thereof</p> <p>Gewicht <i>Belt weight:</i> 1 Rippe <i>rib</i> \approx 0,163 kg/m</p> <p>Mindest-Abnahmemenge für Aramid-Konstruktionen auf Anfrage. <i>Minimum order quantities for Aramid constructions on request.</i></p>	<p>Maximale Fertigungslänge <i>Maximum manufacturing length:</i> 10000 mm L_1 Zwischenlängen ab <i>Intermediate lengths from</i> 1800 mm L_1</p> <p>Mindest-Abnahmemenge für Sonderlängen <i>Minimum quantities for non-listed sizes:</i> 5 Stück <i>pieces</i> à with 5 Rippen <i>ribs</i> oder or 6 Stück <i>pieces</i> à with 4 Rippen <i>ribs</i> oder or 9 Stück <i>pieces</i> à with 3 Rippen <i>ribs</i> oder or 13 Stück <i>pieces</i> à with 2 Rippen <i>ribs</i> oder ein Vielfaches hiervon or multiples thereof</p> <p>Gewicht <i>Belt weight:</i> 1 Rippe <i>rib</i> \approx 0,266 kg/m</p> <p>Mindest-Abnahmemenge für Aramid-Konstruktionen auf Anfrage. <i>Minimum order quantities for Aramid constructions on request.</i></p>	<p>Maximale Fertigungslänge <i>Maximum manufacturing length:</i> 12000 mm L_1 Zwischenlängen ab <i>Intermediate lengths from</i> 2286 mm L_1</p> <p>Mindest-Abnahmemenge für Sonderlängen <i>Minimum quantities for non-listed sizes:</i> 2050 bis up to 10000 mm L_1 4 Stück <i>pieces</i> à with 5 Rippen <i>ribs</i> oder or 5 Stück <i>pieces</i> à with 4 Rippen <i>ribs</i> oder or 6 Stück <i>pieces</i> à with 3 Rippen <i>ribs</i> oder or 10 Stück <i>pieces</i> à with 2 Rippen <i>ribs</i> oder ein Vielfaches hiervon or multiples thereof</p> <p>10001 bis up to 12000 mm L_1 3 Stück <i>pieces</i> à with 5 Rippen <i>ribs</i> oder or 4 Stück <i>pieces</i> à with 4 Rippen <i>ribs</i> oder or 5 Stück <i>pieces</i> à with 3 Rippen <i>ribs</i> oder or 8 Stück <i>pieces</i> à with 2 Rippen <i>ribs</i> oder ein Vielfaches hiervon or multiples thereof</p> <p>Gewicht <i>Belt weight:</i> 1 Rippe <i>rib</i> \approx 0,447 kg/m</p> <p>Mindest-Abnahmemenge für Aramid-Konstruktionen auf Anfrage. <i>Minimum order quantities for Aramid constructions on request.</i></p>	<p>Maximale Fertigungslänge <i>Maximum manufacturing length:</i> 12200 mm L_1 Zwischenlängen ab <i>Intermediate lengths from</i> 2500 mm L_1</p> <p>Mindest-Abnahmemenge für alle Abmessungen <i>Minimum quantities for all sizes:</i> 2 Stück <i>pieces</i> à with 5 Rippen <i>ribs</i> oder or 2 Stück <i>pieces</i> à with 4 Rippen <i>ribs</i> oder or 3 Stück <i>pieces</i> à with 3 Rippen <i>ribs</i> oder or 5 Stück <i>pieces</i> à with 2 Rippen <i>ribs</i> oder ein Vielfaches hiervon or multiples thereof</p> <p>Gewicht <i>Belt weight:</i> 1 Rippe <i>rib</i> \approx 0,798 kg/m</p> <p>Mindest-Abnahmemenge für Aramid-Konstruktionen auf Anfrage. <i>Minimum order quantities for Aramid constructions on request.</i></p>
---	---	--	---

Kraftbänder mit Auflage siehe Seite 30. *Kraftbands with special top surfaces see page 30.*



Profil Sect.	3VX/9JX	5VX/15JX
$b_o \approx$ (mm)	9,0	15,0
$h \approx$ (mm)	9,9	15,1

Profil Section 3VX/9JX		Profil Section 5VX/15JX	
Riemenbezeichnung Belt number (Zoll inch)	Riemenbez. Belt no. Außenlänge Outside length (mm)	Riemenbezeichnung Belt number (Zoll inch)	Riemenbez. Belt no. Außenlänge Outside length (mm)
3VX 500	9JX 1270	5VX 500	15JX 1270
3VX 530	9JX 1346	5VX 530	15JX 1346
3VX 560	9JX 1422	5VX 560	15JX 1422
3VX 600	9JX 1524	5VX 600	15JX 1524
3VX 630	9JX 1600	5VX 630	15JX 1600
3VX 670	9JX 1702	5VX 670	15JX 1702
3VX 710	9JX 1803	5VX 710	15JX 1803
3VX 750	9JX 1905	5VX 750	15JX 1905
3VX 800	9JX 2032	5VX 800	15JX 2032
3VX 850	9JX 2159	5VX 850	15JX 2159
3VX 900	9JX 2286	5VX 900	15JX 2286
3VX 950	9JX 2413	5VX 950	15JX 2413
3VX 1000	9JX 2540	5VX 1000	15JX 2540
3VX 1060	9JX 2692	5VX 1060	15JX 2692
3VX 1120	9JX 2845	5VX 1120	15JX 2845
3VX 1180	9JX 2997	5VX 1180	15JX 2997
3VX 1250	9JX 3175	5VX 1250	15JX 3175
3VX 1320	9JX 3353	5VX 1320	15JX 3353
3VX 1400	9JX 3556	5VX 1400	15JX 3556
Anfertigungsware Non stock items		Anfertigungsware Non stock items	
Weitere Abmessungen auf Anfrage Further sizes on request			

<p>Mindest-Abnahmemenge für alle Abmessungen auf Anfrage. Minimum quantities for all sizes on request.</p> <p>Gewicht Belt weight: 1 Rippe rib \approx 0,117 kg/m</p>	<p>Mindest-Abnahmemenge für alle Abmessungen auf Anfrage. Minimum quantities for all sizes on request.</p> <p>Gewicht Belt weight: 1 Rippe rib \approx 0,241 kg/m</p>
---	---

optibelt **PKR** Endlose Keilriemen DIN 2215 mit Auflage (Anfertigungsware) Endless V-Belts with Special Top Surfaces (Non Stock Items)

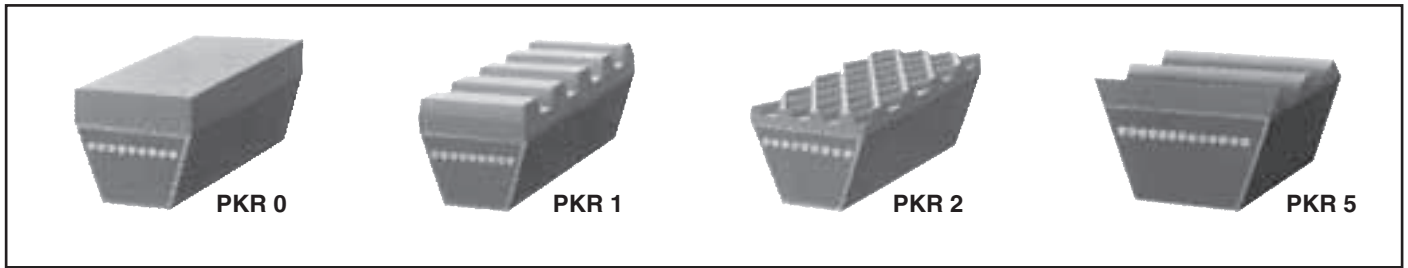

Profilierungsart Patterns	Höhe der Auflage Height of patterns		Teilung Pitch (mm)	Breite der Nut Width of groove (mm)
	Standard (mm)	max. (mm)		
PKR 0	3	5	—	—
PKR 1	3	5	10	—
PKR 2	3	5	—	—
PKR 5	5	—	13	—

Ausführung/Farbe Quality/Colour	Temperaturbest. Temperature resist. (°C)	Härte Hardness (Shore A)	Öl- beständig Oil resist.	Abfärbend Staining
SBR-NR/hell light	- 40 bis up to + 70	≈ 55/65*	nein no	nein no
CR/schwarz black	- 25 bis up to + 100	≈ 65	bedingt limited	ja yes

* ≈ 55 für Auflagen zus. zur Normhöhe for surface above the profile
≈ 65 für Auflagen innerhalb der Normhöhe for surface within profile

SBR = Styrol-Butadiene-Kautschuk Styrene-Butadiene Rubber
NR = Naturkautschuk Natural Rubber
CR = Chloroprene-Kautschuk Chloroprene Rubber

Auflagen mit zusätzlicher Höhe Patterned top surfaces added to normal belt thickness				Auflage 3 oder 5 mm über Normhöhe hinaus Height of patterns 3 or 5 mm above stand. height					
Profil Section	Norm- höhe Stand- ard height (mm)	Standard-Längen- bereich Innenlänge Standard inside length (mm)	Profilierungsart Patterns				Min.-Abnahm. für profilierte Keilriemen Min. quant. for endless V-belts patterned top surfaces PKR 0; PKR 1; PKR 2; PKR 5 für Standard-Sortim. for standard range für Zwischenlängen for intermed. lengths (wie auf Seiten see pages 19 bis to 23 aufgeführt of this list)	Mindestmenge Minimum quantities	
			PKR 0	PKR 1	PKR 2	PKR 5			
A/13	8,0	1200 ≤ 5000 ¹⁾	●	●	●	—	18 St. pcs.	31 St. pcs.	
B/17	11,0	1200 ≤ 2000 ¹⁾	●	●	●	—	15 St. pcs.	50 St. pcs.	
		2001 ≤ 7100 ¹⁾	●	●	●	—	15 St. pcs.	42 St. pcs.	
20	12,5	1850 ≤ 2000 ²⁾	●	●	●	—	13 St. pcs.	21 St. pcs.	
		2001 ≤ 8000 ²⁾	●	●	●	—	13 St. pcs.	36 St. pcs.	
C/22	14,0	1850 ≤ 2000 ²⁾	●	●	●	—	12 St. pcs.	57 St. pcs.	
		2001 ≤ 10000 ²⁾	●	●	●	—	12 St. pcs.	48 St. pcs.	
25	16,0	1850 ≤ 2000 ²⁾	●	●	●	—	11 St. pcs.	51 St. pcs.	
		2001 ≤ 10000 ²⁾	●	●	●	—	11 St. pcs.	42 St. pcs.	
D/32	20,0	2850 ≤ 12500 ²⁾	●	●	●	—	9 St. pcs.	22 St. pcs.	
		2850 ≤ 12500 ²⁾	—	—	—	● ³⁾	8 St. pcs.	8 St. pcs.	
E/40	25,0	—	—	—	—	auf Anfrage on request	auf Anfrage on request		

1) Max. Fertigungslänge auf Anfrage. Max. production length on request.

2) Max. Fertigungslänge Max. production length 21 000 mm.

3) Nur in CR/schwarz lieferbar. Only in CR/black.

Auflagen innerhalb der Normhöhe Patterned top surfaces within standard height			
Standard-Längen- bereich Innenlänge Standard inside length (mm)	Profilierungsart Patterns		Mindest- menge Minimum quantities
	PKR 0	PKR 2	
3550 ≤ 10000 ¹⁾	●	●	10
2850 ≤ 21000 ¹⁾	●	●	10
3550 ≤ 21000 ¹⁾	●	●	8
3550 ≤ 21000 ¹⁾	●	●	8
2850 ≤ 21000 ¹⁾	●	●	8
2850 ≤ 21000 ¹⁾	●	●	6
4000 ≤ 21000 ¹⁾	●	●	5

CR/schwarz auf Anfrage.
CR/black on request.

Sortiment für Standardausführungen: Siehe Seite 14 bis 17.
Length range: see pages 14 to 17.

Profil Z/10 auf Anfrage.
Section Z/10 on request.

Bei Bestellungen ist die Gesamthöhe des Keilriemens incl. Auflage bekannt zu geben.
Dies erfolgt über die Profilbezeichnung wie nachfolgend aufgezeigt:
On the order, please mention the total height of the V-belt.
The addition of patterned top surfaces within normal belt thickness
and the section identification as follow:

Profil Section B/17 – Auflage innerhalb der Normhöhe surface within the section thickness = 17 x 11
Profil Section B/17 – mit zusätzlicher Auflage surface added to section thickness 3 mm = 17 x 14
Profil Section B/17 – mit zusätzlicher Auflage surface added to section thickness 5 mm = 17 x 16

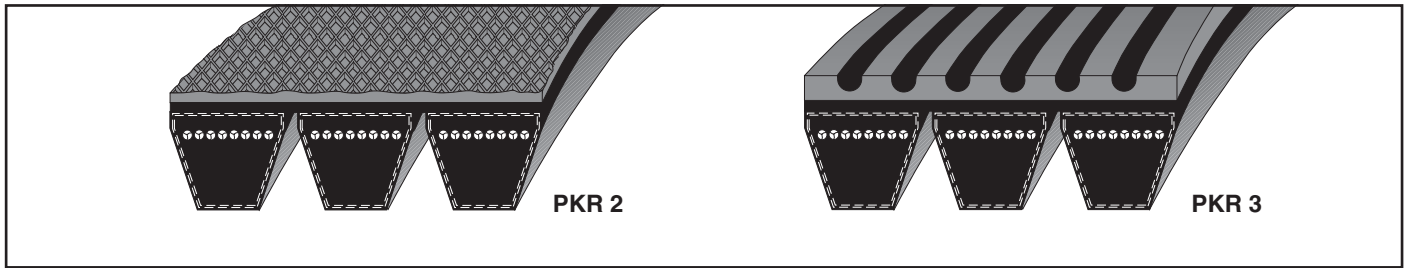

Profilierungsart Patterns	Höhe der Auflage Height of patterns		Teilung Pitch (mm)	Breite der Nut Width of groove (mm)
	Standard (mm)	max. (mm)		
PKR 0	3	5	—	—
PKR 1	3	5	10	—
PKR 2	3	5	—	—
PKR 3	5	—	—	3,7

Ausführung/Farbe Quality/Colour	Temperaturbest. Temperature resist. (°C)	Härte Hardness (Shore A)	Öl- beständig Oil resist.	Abfärbend Staining
SBR-NR/hell light	- 40 bis up to + 70	≈ 55	nein no	nein no
CR/schwarz black	- 25 bis up to + 100	≈ 65	bedingt limited	ja yes

SBR = Styrol-Butadiene-Kautschuk *Styrene-Butadiene Rubber*
 NR = Naturkautschuk *Natural Rubber*
 CR = Chloroprene-Kautschuk *Chloroprene Rubber*

Profil Section	Querschnittsmaße des Grundriemens Dimensions of the basic belt (mm)	Kraftbandhöhe ohne Auflage Kraftband height without surface (mm)	Längen- bezeichnung Length designation	Länge Length (mm)	Max. Fertigungslänge Max. production length (mm)	Profilierungsart Patterns			
						PKR 0	PKR 1	PKR 2	PKR 3
3V/9J	9 x 8	9,9	500 ≤ 1400	1400 ≤ 3556 L _a	4250	●	●	●	—
5V/15J	15 x 13	15,1	500 ≤ 3550	1400 ≤ 9017 L _a	10 000	●	●	●	—
8V/25J	25 x 23	25,5	1000 ≤ 4750	2540 ≤ 12 065 L _a	15 000	●	●	●	—
SPB	16,3 x 13	15,6	—	2400 ≤ 6000 L _d	6000	●	●	●	—
A/HA	13 x 8	9,9	—	1400 ≤ 5000 L _i	8000	●	●	●	—
				2850 ≤ 8000 L _i	auf Anfrage on request	—	—	—	●
B/HB	17 x 11	13,0	—	1400 ≤ 7100 L _i	10 000	●	●	●	—
C/HC	22 x 14	16,2	—	2050 ≤ 7100 L _i	12 000	●	●	●	—

Zahnflachriemen Chloropren

Timing Belts Chloroprene

optibelt



optibelt OMEGA HP



optibelt OMEGA HL



optibelt OMEGA



optibelt OMEGA RAINBOW



optibelt OMEGA linear
optibelt OMEGA HP linear



optibelt ZR / ZR D



optibelt HTD®/HTD® D



optibelt ZR linear

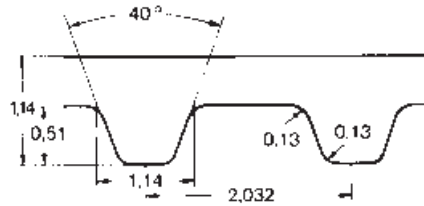

Type MXL (nur Mittelwerte nominal dimensions – mm)

Type MXL – Teilung pitch 2,032 mm

Artikel- Bezeichnung Designation	Wirklänge Pitch length		Anzahl der Zähne Number of teeth	Artikel- Bezeichnung Designation	Wirklänge Pitch length		Anzahl der Zähne Number of teeth
	(Zoll inch)	(mm)			(Zoll inch)	(mm)	
360 MXL	3,60	91,44	45	1200 MXL•	12,00	304,80	150
432 MXL•	4,32	109,73	54	1224 MXL•	12,24	310,90	153
440 MXL	4,40	111,76	55	1272 MXL•	12,72	323,09	159
448 MXL•	4,48	113,79	56	1280 MXL•	12,80	325,12	160
456 MXL•	4,56	115,82	57	1320 MXL•	13,20	335,28	165
464 MXL•	4,64	117,86	58	1360 MXL•	13,60	345,44	170
480 MXL	4,80	121,92	60	1400 MXL	14,00	355,60	175
488 MXL•	4,88	123,95	61	1440 MXL•	14,40	365,76	180
536 MXL•	5,36	136,14	67	1472 MXL•	14,72	373,89	184
544 MXL•	5,44	138,18	68	1520 MXL•	15,20	386,08	190
560 MXL•	5,60	142,24	70	1560 MXL•	15,60	396,24	195
568 MXL•	5,68	144,27	71	1600 MXL•	16,00	406,40	200
576 MXL•	5,76	146,30	72	1768 MXL•	17,68	449,07	221
600 MXL•	6,00	152,40	75	1800 MXL•	18,00	457,20	225
608 MXL•	6,08	154,43	76	1888 MXL•	18,88	479,55	236
632 MXL•	6,32	160,53	79	1984 MXL•	19,84	503,94	248
640 MXL	6,40	162,56	80	1992 MXL•	19,92	505,97	249
656 MXL•	6,56	166,62	82	2008 MXL•	20,08	510,03	251
664 MXL•	6,64	168,66	83	2048 MXL•	20,48	520,19	256
672 MXL•	6,72	170,69	84	2144 MXL•	21,44	544,58	268
680 MXL•	6,80	172,72	85	2240 MXL•	22,40	568,96	280
704 MXL•	7,04	178,82	88	2384 MXL•	23,84	605,54	298
720 MXL•	7,20	182,88	90	2480 MXL•	24,80	629,92	310
728 MXL•	7,28	184,91	91	2520 MXL•	25,20	640,08	315
736 MXL•	7,36	186,94	92	2680 MXL•	26,80	680,72	335
752 MXL•	7,52	191,01	94	2776 MXL•	27,76	705,10	347
760 MXL•	7,60	193,04	95	2880 MXL•	28,80	731,52	360
776 MXL•	7,76	197,10	97	2920 MXL•	29,20	741,68	365
800 MXL•	8,00	203,20	100	3200 MXL•	32,00	812,80	400
808 MXL•	8,08	205,23	101	3472 MXL•	34,72	881,89	434
816 MXL•	8,16	207,26	102	3624 MXL•	36,24	920,50	453
824 MXL•	8,24	209,30	103	3704 MXL•	37,04	940,82	463
840 MXL•	8,40	213,36	105	3984 MXL•	39,84	1011,94	498
848 MXL•	8,48	215,39	106	4040 MXL•	40,40	1026,16	505
856 MXL•	8,56	217,42	107				
864 MXL•	8,64	219,46	108				
880 MXL	8,80	223,52	110				
896 MXL•	8,96	227,58	112				
904 MXL•	9,04	229,62	113				
912 MXL•	9,12	231,65	114				
920 MXL•	9,20	233,68	115				
960 MXL•	9,60	243,84	120				
976 MXL•	9,76	247,90	122				
984 MXL•	9,84	249,94	123				
1000 MXL•	10,00	254,00	125				
1008 MXL•	10,08	256,03	126				
1040 MXL•	10,40	264,16	130				
1056 MXL•	10,56	268,22	132				
1072 MXL•	10,72	272,29	134				
1080 MXL•	10,80	274,32	135				
1112 MXL•	11,12	282,45	139				
1120 MXL	11,20	284,48	140				
1136 MXL•	11,36	288,54	142				
1176 MXL•	11,76	298,70	147				
1184 MXL•	11,84	300,74	148				

Breite Standard widths: 1/8" – Code 012; 3/16" – Code 019; 1/4" – Code 025.

Weitere Abmessungen auf Anfrage. Further sizes on request. • Keine Lagerware, Mindestabnahme: 2 Wickel • Non stock items, minimum order quantity: 2 sleeves

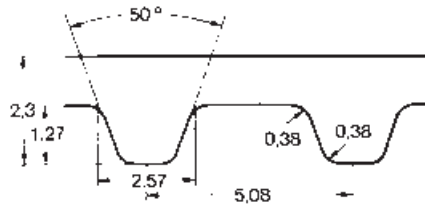

Type XL (nur Mittelwerte nominal dimensions – mm)

Type XL – Teilung *pitch* 5,08 mm

Artikel- Bezeichnung <i>Designation</i>	Wirklänge <i>Pitch length</i>		Anzahl der Zähne <i>Number of teeth</i>	Artikel- Bezeichnung <i>Designation</i>	Wirklänge <i>Pitch length</i>		Anzahl der Zähne <i>Number of teeth</i>
	(Zoll <i>inch</i>)	(mm)			(Zoll <i>inch</i>)	(mm)	
60 XL	6,00	152,40	30	274 XL•	27,40	695,96	137
70 XL	7,00	177,80	35	280 XL	28,00	711,20	140
80 XL	8,00	203,20	40	286 XL•	28,60	726,44	143
86 XL•	8,60	218,44	43	290 XL	29,00	736,60	145
88 XL	8,80	223,52	44	296 XL•	29,60	751,84	148
90 XL	9,00	228,60	45	300 XL	30,00	762,00	150
92 XL•	9,20	233,68	46	306 XL•	30,60	777,24	153
94 XL•	9,40	238,76	47	310 XL	31,00	787,40	155
96 XL•	9,60	243,84	48	316 XL	31,60	802,64	158
100 XL	10,00	254,00	50	320 XL	32,00	812,80	160
102 XL•	10,20	259,08	51	322 XL	32,20	817,88	161
106 XL	10,60	269,24	53	330 XL	33,00	838,20	165
108 XL•	10,80	274,32	54	340 XL•	34,00	863,60	170
110 XL	11,00	279,40	55	344 XL•	34,40	873,76	172
112 XL•	11,20	284,48	56	350 XL•	35,00	889,00	175
116 XL	11,60	294,64	58	360 XL	36,00	914,40	180
118 XL•	11,80	299,72	59	380 XL	38,00	965,20	190
120 XL	12,00	304,80	60	382 XL•	38,20	970,28	191
124 XL•	12,40	314,96	62	388 XL•	38,80	985,52	194
126 XL	12,60	320,04	63	390 XL	39,00	990,60	195
128 XL	12,80	325,12	64	392 XL•	39,20	995,68	196
130 XL	13,00	330,20	65	412 XL	41,20	1046,48	206
134 XL	13,40	340,36	67	414 XL	41,40	1051,56	207
136 XL	13,60	345,44	68	432 XL•	43,20	1097,28	216
138 XL•	13,80	350,52	69	438 XL•	43,80	1112,52	219
140 XL	14,00	355,60	70	460 XL•	46,00	1168,40	230
148 XL•	14,80	375,92	74	498 XL•	49,80	1264,92	249
150 XL	15,00	381,00	75	506 XL•	50,60	1285,24	253
156 XL	15,60	396,24	78	514 XL	51,40	1305,56	257
160 XL	16,00	406,40	80	580 XL•	58,00	1473,20	290
162 XL•	16,20	411,48	81	630 XL•	63,00	1600,20	315
168 XL•	16,80	426,72	84				
170 XL	17,00	431,80	85				
174 XL•	17,40	441,96	87				
176 XL	17,60	447,04	88				
178 XL•	17,80	452,12	89				
180 XL	18,00	457,20	90				
182 XL	18,20	462,28	91				
184 XL•	18,40	467,36	92				
188 XL•	18,80	477,52	94				
190 XL	19,00	482,60	95				
192 XL•	19,20	487,68	96				
194 XL•	19,40	492,76	97				
196 XL•	19,60	497,84	98				
200 XL	20,00	508,00	100				
210 XL	21,00	533,40	105				
220 XL	22,00	558,80	110				
230 XL	23,00	584,20	115				
240 XL	24,00	609,60	120				
244 XL•	24,40	619,76	122				
248 XL•	24,80	629,92	124				
250 XL	25,00	635,00	125				
260 XL	26,00	660,40	130				
270 XL	27,00	685,80	135				
272 XL•	27,20	690,88	136				

Breite *Standard widths*: 1/4" – Code **025**; 5/16" – Code **031**; 3/8" – Code **037**.

Weitere Abmessungen auf Anfrage. *Further sizes on request.* • Keine Lagerware, Mindestabnahme: 2 Wickel • *Non stock items, minimum order quantity: 2 sleeves*

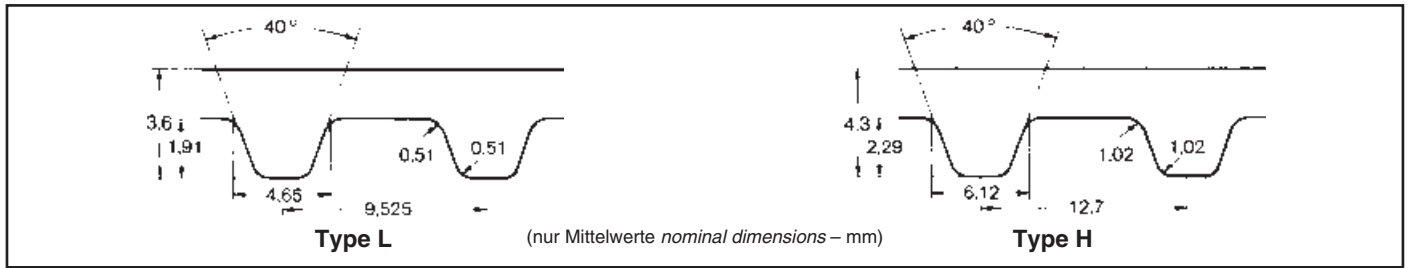

Type L – Teilung <i>pitch</i> 9,525 mm				Type H – Teilung <i>pitch</i> 12,7 mm			
Artikel- Bezeichnung <i>Designation</i>	Wirklänge <i>Pitch length</i>		Anzahl der Zähne <i>Number of teeth</i>	Artikel- Bezeichnung <i>Designation</i>	Wirklänge <i>Pitch length</i>		Anzahl der Zähne <i>Number of teeth</i>
	(Zoll <i>inch</i>)	(mm)			(Zoll <i>inch</i>)	(mm)	
109 L	10,88	276,23	29	230 H	23,00	584,20	46
124 L	12,38	314,33	33	240 H	24,00	609,60	48
150 L	15,00	381,00	40	255 H	25,50	647,70	51
169 L	16,88	428,63	45	270 H	27,00	685,80	54
173 L	17,25	438,15	46	280 H	28,00	711,20	56
187 L	18,75	476,25	50	300 H	30,00	762,00	60
210 L	21,00	533,40	56	330 H	33,00	838,20	66
225 L	22,50	571,50	60	335 H	33,50	850,90	67
236 L	23,63	600,08	63	350 H	35,00	889,00	70
240 L	24,00	609,60	64	360 H	36,00	914,40	72
255 L	25,50	647,70	68	370 H	37,00	939,80	74
270 L	27,00	685,80	72	390 H	39,00	990,60	78
285 L	28,50	723,90	76	400 H	40,00	1016,00	80
300 L	30,00	762,00	80	420 H	42,00	1066,80	84
322 L	32,25	819,15	86	430 H	43,00	1092,20	86
345 L	34,50	876,30	92	450 H	45,00	1143,00	90
360 L	36,00	914,40	96	465 H	46,50	1181,10	93
367 L	36,75	933,45	98	480 H	48,00	1219,20	96
390 L	39,00	990,60	104	510 H	51,00	1295,40	102
405 L	40,50	1028,70	108	540 H	54,00	1371,60	108
420 L	42,00	1066,80	112	560 H	56,00	1422,40	112
435 L	43,50	1104,90	116	570 H	57,00	1447,80	114
450 L	45,00	1143,00	120	600 H	60,00	1524,00	120
454 L	45,38	1152,53	121	630 H	63,00	1600,20	126
480 L	48,00	1219,20	128	650 H	65,00	1651,00	130
510 L	51,00	1295,40	136	660 H	66,00	1676,40	132
525 L	52,50	1333,50	140	680 H	68,00	1727,20	136
540 L	54,00	1371,60	144	700 H	70,00	1778,00	140
600 L	60,00	1524,00	160	730 H	73,00	1854,20	146
630 L	63,00	1600,20	168	750 H	75,00	1905,00	150
660 L	66,00	1676,40	176	770 H	77,00	1955,80	154
				800 H	80,00	2032,00	160
				850 H	85,00	2159,00	170
				860 H	86,00	2184,40	172
				900 H	90,00	2286,00	180
				950 H	95,00	2413,00	190
				1000 H	100,00	2540,00	200
				1100 H	110,00	2794,00	220
				1250 H	125,00	3175,00	250
				1400 H	140,00	3556,00	280
				1700 H	170,00	4318,00	340

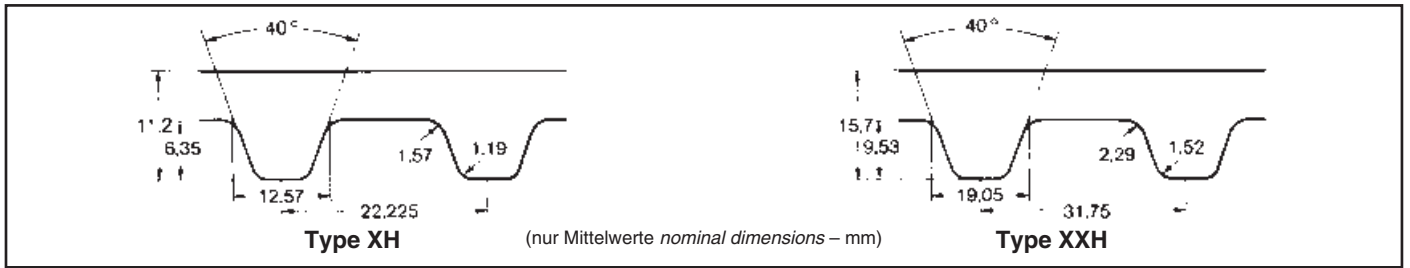

Type XH – Teilung <i>pitch</i> 22,225 mm				Type XXH – Teilung <i>pitch</i> 31,75 mm			
Artikel- Bezeichnung <i>Designation</i>	Wirklänge <i>Pitch length</i>		Anzahl der Zähne <i>Number of teeth</i>	Artikel- Bezeichnung <i>Designation</i>	Wirklänge <i>Pitch length</i>		Anzahl der Zähne <i>Number of teeth</i>
	(Zoll <i>inch</i>)	(mm)			(Zoll <i>inch</i>)	(mm)	
507 XH	50,75	1289,05	58	700 XXH	70,00	1778,00	56
560 XH	56,00	1422,40	64	800 XXH	80,00	2032,00	64
630 XH	63,00	1600,20	72	900 XXH	90,00	2286,00	72
700 XH	70,00	1778,00	80	1000 XXH	100,00	2540,00	80
770 XH	77,00	1955,80	88	1200 XXH	120,00	3048,00	96
840 XH	84,00	2133,60	96	1400 XXH	140,00	3556,00	112
980 XH	98,00	2489,20	112	1600 XXH	160,00	4064,00	128
1120 XH	112,00	2844,80	128	1800 XXH	180,00	4572,00	144
1260 XH	126,00	3200,40	144				
1400 XH	140,00	3556,00	160				
1540 XH	154,00	3911,60	176				
1750 XH	175,00	4445,00	200				

Breite *Standard widths*:

Type XH/XXH: 2" – Code 200; 3" – Code 300; 4" – Code 400; 5" – Code 500.

optibelt ZR D Doppel-Zahnflachriemen Double Timing Belts

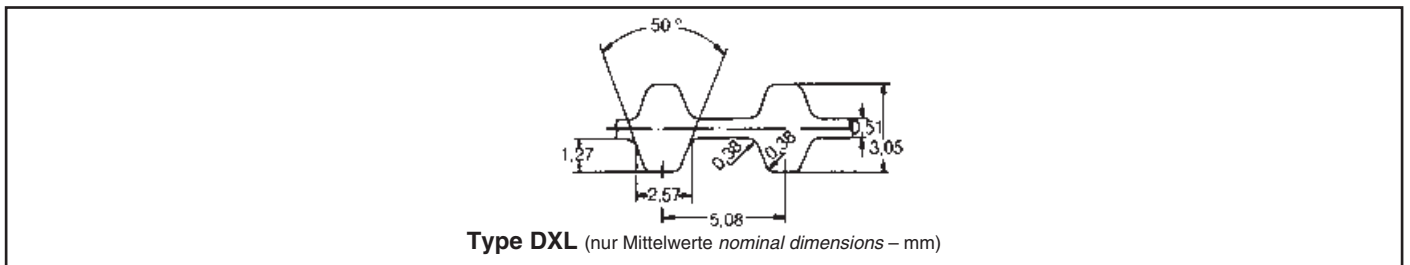

Type DXL (nur Mittelwerte *nominal dimensions* – mm)

Type DXL – Teilung <i>pitch</i> 5,08 mm			
Artikel- Bezeichnung <i>Designation</i>	Wirklänge <i>Pitch length</i>		Anzahl der Zähne <i>Number of teeth</i>
	(Zoll <i>inch</i>)	(mm)	
150 DXL	15,00	381,00	75
160 DXL	16,00	406,40	80
170 DXL	17,00	431,80	85
180 DXL	18,00	457,20	90
190 DXL	19,00	482,60	95
200 DXL	20,00	508,00	100
210 DXL	21,00	533,40	105
220 DXL	22,00	558,80	110
230 DXL	23,00	584,20	115
240 DXL	24,00	609,60	120
250 DXL	25,00	635,00	125
260 DXL	26,00	660,40	130
280 DXL	28,00	711,20	140
300 DXL	30,00	762,00	150
310 DXL	31,00	787,40	155

Breite *Standard widths*: 1/4" – Code 025; 5/16" – Code 031; 3/8" – Code 037.

Weitere Abmessungen auf Anfrage. *Further sizes on request.*

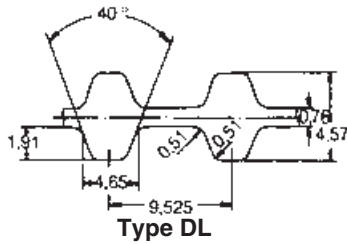

Type DL

(nur Mittelwerte nominal dimensions – mm)

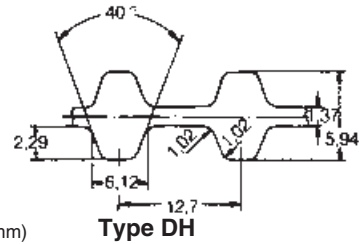

Type DH

Type DL – Teilung <i>pitch</i> 9,525 mm				Type DH – Teilung <i>pitch</i> 12,7 mm			
Artikel- Bezeichnung <i>Designation</i>	Wirklänge <i>Pitch length</i>		Anzahl der Zähne <i>Number of teeth</i>	Artikel- Bezeichnung <i>Designation</i>	Wirklänge <i>Pitch length</i>		Anzahl der Zähne <i>Number of teeth</i>
	(Zoll <i>inch</i>)	(mm)			(Zoll <i>inch</i>)	(mm)	
187 DL	18,75	476,25	50	240 DH	24,00	609,60	48
210 DL	21,00	533,40	56	270 DH	27,00	685,80	54
225 DL	22,50	571,50	60	300 DH	30,00	762,00	60
240 DL	24,00	609,60	64	330 DH	33,00	838,20	66
255 DL	25,50	647,70	68	360 DH	36,00	914,40	72
270 DL	27,00	685,80	72	390 DH	39,00	990,60	78
285 DL	28,50	723,90	76	420 DH	42,00	1066,80	84
300 DL	30,00	762,00	80	450 DH	45,00	1143,00	90
322 DL	32,25	819,15	86	480 DH	48,00	1219,20	96
345 DL	34,50	876,30	92	510 DH	51,00	1295,40	102
367 DL	36,75	933,45	98	540 DH	54,00	1371,60	108
390 DL	39,00	990,60	104	570 DH	57,00	1447,80	114
420 DL	42,00	1066,80	112	600 DH	60,00	1524,00	120
450 DL	45,00	1143,00	120	630 DH	63,00	1600,20	126
480 DL	48,00	1219,20	128	660 DH	66,00	1676,40	132
510 DL	51,00	1295,40	136	700 DH	70,00	1778,00	140
540 DL	54,00	1371,60	144	750 DH	75,00	1905,00	150
600 DL	60,00	1524,00	160	800 DH	80,00	2032,00	160
				850 DH	85,00	2159,00	170
				900 DH	90,00	2286,00	180
				1000 DH	100,00	2540,00	200
				1100 DH	110,00	2794,00	220
				1250 DH	125,00	3175,00	250
				1400 DH	140,00	3556,00	280
				1700 DH	170,00	4318,00	340

Breite *Standard widths*:

Type DL: 1/2" – Code 050; 3/4" – Code 075; 1" – Code 100.

Breite *Standard widths*:

Type DH: 3/4" – Code 075; 1" – Code 100; 1 1/2" – Code 150; 2" – Code 200; 3" – Code 300.

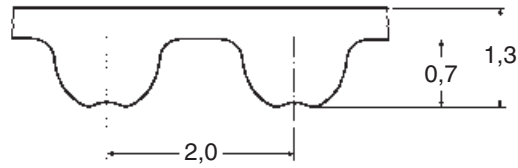

Type 2M (nur Mittelwerte *nominal dimensions* – mm)

Type 2M – Teilung *pitch* 2 mm

Artikel- Bezeichnung <i>Designation</i>	Wirklänge <i>Pitch length</i> (mm)	Anzahl der Zähne <i>Number of teeth</i>
90 2M•	90,00	45
100 2M•	100,00	50
104 2M•	104,00	52
112 2M•	112,00	56
118 2M•	118,00	59
120 2M•	120,00	60
124 2M•	124,00	62
130 2M•	130,00	65
140 2M•	140,00	70
148 2M•	148,00	74
180 2M•	180,00	90
184 2M•	184,00	92
188 2M•	188,00	94
200 2M•	200,00	100
208 2M•	208,00	104
216 2M•	216,00	108
232 2M•	232,00	116
250 2M•	250,00	125
256 2M•	256,00	128
266 2M•	266,00	133
274 2M•	274,00	137
280 2M•	280,00	140
308 2M•	308,00	154
310 2M•	310,00	155
328 2M•	328,00	164
330 2M•	330,00	165
340 2M•	340,00	170
368 2M•	368,00	184
370 2M•	370,00	185
426 2M•	426,00	213
448 2M•	448,00	224
558 2M•	558,00	279
560 2M•	560,00	280
710 2M•	710,00	355
984 2M•	984,00	492
1066 2M•	1066,00	533
1224 2M•	1224,00	612

Breite *Standard widths*: 3 mm – Code 3; 6 mm – Code 6; 9 mm – Code 9.

Weitere Abmessungen auf Anfrage. *Further sizes on request.* • Keine Lagerware, Mindestabnahme: 2 Wickel • *Non stock items, minimum order quantity: 2 sleeves*

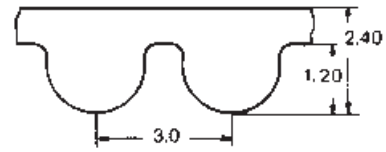
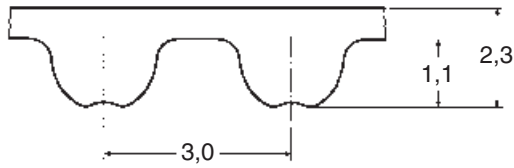

Type 3M (nur Mittelwerte nominal dimensions – mm)

Type 3M – Teilung pitch 3 mm

Artikel- Bezeichnung Designation	Wirklänge Pitch length (mm)	Anzahl der Zähne Number of teeth	Artikel- Bezeichnung Designation	Wirklänge Pitch length (mm)	Anzahl der Zähne Number of teeth
111 3M	111,00	37	462 3M	462,00	154
117 3M (HTD)•	117,00	39	474 3M	474,00	158
120 3M (HTD)•	120,00	40	477 3M (HTD)•	477,00	159
123 3M (HTD)•	123,00	41	480 3M	480,00	160
126 3M (HTD)•	126,00	42	486 3M	486,00	162
129 3M	129,00	43	489 3M (HTD)•	489,00	163
141 3M	141,00	47	495 3M	495,00	165
144 3M	144,00	48	501 3M	501,00	167
150 3M	150,00	50	513 3M	513,00	171
156 3M (HTD)•	156,00	52	519 3M	519,00	173
159 3M (HTD)•	159,00	53	522 3M	522,00	174
165 3M	165,00	55	525 3M	525,00	175
168 3M	168,00	56	531 3M	531,00	177
171 3M	171,00	57	537 3M	537,00	179
174 3M	174,00	58	558 3M	558,00	186
177 3M	177,00	59	564 3M	564,00	188
180 3M	180,00	60	570 3M	570,00	190
183 3M	183,00	61	582 3M (HTD)	582,00	194
186 3M	186,00	62	591 3M (HTD)•	591,00	197
192 3M	192,00	64	594 3M (HTD)•	594,00	198
195 3M	195,00	65	597 3M	597,00	199
201 3M	201,00	67	600 3M	600,00	200
204 3M	204,00	68	606 3M	606,00	202
207 3M	207,00	69	612 3M (HTD)•	612,00	204
210 3M	210,00	70	615 3M	615,00	205
213 3M	213,00	71	633 3M	633,00	211
216 3M (HTD)	216,00	72	648 3M (HTD)•	648,00	216
225 3M	225,00	75	669 3M	669,00	223
237 3M (HTD)•	237,00	79	672 3M (HTD)•	672,00	224
240 3M	240,00	80	675 3M	675,00	225
243 3M (HTD)•	243,00	81	708 3M (HTD)•	708,00	236
246 3M (HTD)	246,00	82	711 3M	711,00	237
249 3M (HTD)•	249,00	83	738 3M	738,00	246
252 3M	252,00	84	753 3M (HTD)	753,00	251
255 3M	255,00	85	804 3M	804,00	268
267 3M	267,00	89	816 3M	816,00	272
276 3M (HTD)•	276,00	92	843 3M	843,00	281
282 3M (HTD)•	282,00	94	882 3M	882,00	294
285 3M	285,00	95	888 3M	888,00	296
288 3M	288,00	96	945 3M (HTD)	945,00	315
291 3M	291,00	97	960 3M (HTD)•	960,00	320
294 3M	294,00	98	1041 3M (HTD)•	1041,00	347
300 3M	300,00	100	1062 3M	1062,00	354
306 3M (HTD)•	306,00	102	1068 3M (HTD)•	1068,00	356
312 3M	312,00	104	1071 3M (HTD)	1071,00	357
315 3M	315,00	105	1125 3M (HTD)•	1125,00	375
318 3M	318,00	106	1176 3M (HTD)•	1176,00	392
330 3M	330,00	110	1245 3M (HTD)•	1245,00	415
333 3M (HTD)	333,00	111	1263 3M (HTD)	1263,00	421
336 3M (HTD)	336,00	112	1500 3M (HTD)•	1500,00	500
339 3M	339,00	113	1530 3M (HTD)•	1530,00	510
345 3M	345,00	115	1569 3M	1569,00	523
357 3M	357,00	119	1863 3M (HTD)	1863,00	621
363 3M	363,00	121			
366 3M	366,00	122			
384 3M	384,00	128			
390 3M	390,00	130			
420 3M	420,00	140			
426 3M	426,00	142			
447 3M	447,00	149			

Breite Standard widths: 6 mm – Code 6; 9 mm – Code 9; 15 mm – Code 15.

Weitere Abmessungen auf Anfrage. Further sizes on request. • Keine Lagerware, Mindestabnahme: 2 Wickel • Non stock items, minimum order quantity: 2 sleeves

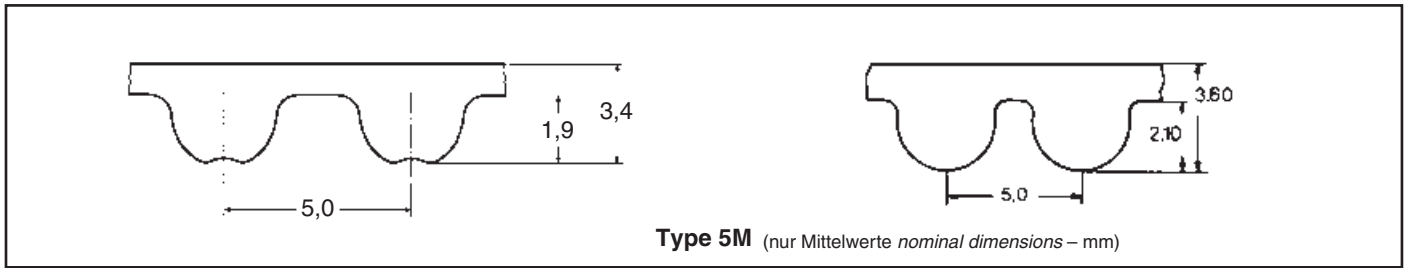

Type 5M – Teilung *pitch* 5 mm

Artikel- Bezeichnung <i>Designation</i>	Wirklänge <i>Pitch length</i> (mm)	Anzahl der Zähne <i>Number of teeth</i>	Artikel- Bezeichnung <i>Designation</i>	Wirklänge <i>Pitch length</i> (mm)	Anzahl der Zähne <i>Number of teeth</i>
120 5M (HTD)	120,00	24	790 5M•	790,00	158
180 5M	180,00	36	800 5M	800,00	160
225 5M	225,00	45	825 5M	825,00	165
255 5M	255,00	51	835 5M	835,00	167
265 5M	265,00	5	850 5M	850,00	170
270 5M	270,00	54	860 5M	860,00	172
280 5M	280,00	56	890 5M	890,00	178
295 5M	295,00	59	900 5M	900,00	180
300 5M	300,00	60	925 5M	925,00	185
305 5M	305,00	61	935 5M	935,00	187
325 5M	325,00	65	940 5M (HTD)	940,00	188
330 5M	330,00	66	950 5M	950,00	190
340 5M	340,00	68	965 5M	965,00	193
345 5M (HTD)	345,00	69	980 5M	980,00	196
350 5M	350,00	70	1000 5M	1000,00	200
360 5M	360,00	72	1035 5M	1035,00	207
365 5M	365,00	73	1050 5M	1050,00	210
370 5M	370,00	74	1100 5M	1100,00	220
375 5M	375,00	75	1125 5M	1125,00	225
385 5M	385,00	77	1135 5M	1135,00	227
400 5M	400,00	80	1200 5M	1200,00	240
415 5M	415,00	83	1270 5M	1270,00	254
425 5M	425,00	85	1400 5M	1400,00	280
450 5M	450,00	90	1420 5M	1420,00	284
460 5M (HTD)	460,00	92	1425 5M	1425,00	285
475 5M	475,00	95	1500 5M	1500,00	300
490 5M	490,00	98	1595 5M	1595,00	319
500 5M	500,00	100	1690 5M	1690,00	338
520 5M	520,00	104	1790 5M	1790,00	358
525 5M	525,00	105	1800 5M (HTD)•	1800,00	360
535 5M	535,00	107	1870 5M	1870,00	374
540 5M	540,00	108	1895 5M	1895,00	379
550 5M	550,00	110	2000 5M	2000,00	400
560 5M	560,00	112	2110 5M	2110,00	422
565 5M	565,00	113	2350 5M	2350,00	470
575 5M	575,00	115	2525 5M	2525,00	505
580 5M	580,00	116			
600 5M	600,00	120			
610 5M	610,00	122			
615 5M	615,00	123			
620 5M (HTD)	620,00	124			
630 5M	630,00	126			
635 5M	635,00	127			
640 5M	640,00	128			
645 5M	645,00	129			
650 5M	650,00	130			
665 5M	665,00	133			
670 5M	670,00	134			
700 5M	700,00	140			
710 5M	710,00	142			
720 5M	720,00	144			
740 5M	740,00	148			
750 5M	750,00	150			
755 5M	755,00	151			
775 5M	775,00	155			

Breite *Standard widths*: 9 mm – Code 9; 15 mm – Code 15; 25 mm – Code 25.

Weitere Abmessungen auf Anfrage. *Further sizes on request.* • Keine Lagerware, Mindestabnahme: 2 Wickel • *Non stock items, minimum order quantity: 2 sleeves*

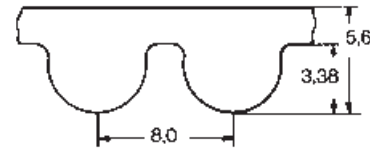
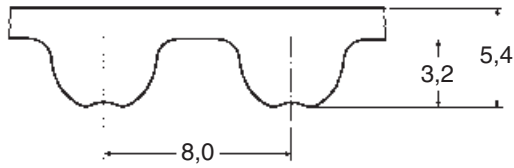

Type 8M (nur Mittelwerte *nominal dimensions* – mm)

Type 8M – Teilung *pitch* 8 mm

Artikel- Bezeichnung <i>Designation</i>	Wirklänge <i>Pitch length</i> (mm)	Anzahl der Zähne <i>Number of teeth</i>	Artikel- Bezeichnung <i>Designation</i>	Wirklänge <i>Pitch length</i> (mm)	Anzahl der Zähne <i>Number of teeth</i>
320 8M (HTD)	320,00	40	1432 8M (HTD)	1432,00	179
352 8M•	352,00	44	1440 8M	1440,00	180
376 8M (HTD)	376,00	47	1520 8M	1520,00	190
424 8M	424,00	53	1552 8M	1552,00	194
480 8M	480,00	60	1600 8M	1600,00	200
512 8M	512,00	64	1680 8M	1680,00	210
520 8M	520,00	65	1696 8M	1696,00	212
560 8M	560,00	70	1728 8M	1728,00	216
576 8M	576,00	72	1760 8M	1760,00	220
600 8M	600,00	75	1800 8M	1800,00	225
608 8M	608,00	76	1904 8M	1904,00	238
624 8M (HTD)	624,00	78	1936 8M	1936,00	242
632 8M	632,00	79	2000 8M	2000,00	250
640 8M	640,00	80	2080 8M	2080,00	260
656 8M	656,00	82	2104 8M	2104,00	263
680 8M	680,00	85	2240 8M	2240,00	280
712 8M	712,00	89	2248 8M	2248,00	281
720 8M	720,00	90	2272 8M	2272,00	284
760 8M	760,00	95	2400 8M	2400,00	300
776 8M	776,00	97	2504 8M	2504,00	313
784 8M	784,00	98	2600 8M	2600,00	325
800 8M	800,00	100	2800 8M	2800,00	350
824 8M	824,00	103	3048 8M*	3048,00	381
840 8M	840,00	105	3280 8M*	3280,00	410
848 8M	848,00	106	3600 8M*	3600,00	450
856 8M	856,00	107	4400 8M*	4400,00	550
880 8M	880,00	110			
896 8M	896,00	112			
912 8M	912,00	114			
920 8M	920,00	115			
960 8M	960,00	120			
976 8M	976,00	122			
1000 8M	1000,00	125			
1040 8M	1040,00	130			
1056 8M	1056,00	132			
1064 8M	1064,00	133			
1080 8M	1080,00	135			
1096 8M	1096,00	137			
1120 8M	1120,00	140			
1128 8M	1128,00	141			
1160 8M	1160,00	145			
1184 8M	1184,00	148			
1200 8M	1200,00	150			
1216 8M	1216,00	152			
1224 8M	1224,00	153			
1248 8M	1248,00	156			
1256 8M	1256,00	157			
1264 8M (HTD)•	1264,00	158			
1280 8M	1280,00	160			
1304 8M	1304,00	163			
1328 8M	1328,00	166			
1344 8M	1344,00	168			
1360 8M	1360,00	170			
1400 8M	1400,00	175			
1424 8M	1424,00	178			

Breite *Standard widths*: 20 mm – Code **20**; 30 mm – Code **30**; 50 mm – Code **50**; 85 mm – Code **85**.

Weitere Abmessungen auf Anfrage. *Further sizes on request.* • Keine Lagerware, Mindestabnahme: 2 Wickel • *Non stock items, minimum order quantity: 2 sleeves*

* Profil auf Anfrage. * *Section on request.*

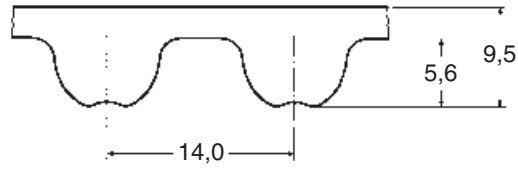

Type 14M (nur Mittelwerte *nominal dimensions* – mm)

Type 14M – Teilung *pitch* 14 mm

Artikel- Bezeichnung <i>Designation</i>	Wirklänge <i>Pitch length</i> (mm)	Anzahl der Zähne <i>Number of teeth</i>
966 14M	966,00	69
1092 14M	1092,00	78
1190 14M	1190,00	85
1400 14M	1400,00	100
1610 14M	1610,00	115
1778 14M	1778,00	127
1890 14M	1890,00	135
2100 14M	2100,00	150
2310 14M	2310,00	165
2450 14M	2450,00	175
2590 14M	2590,00	185
2800 14M	2800,00	200
3150 14M*	3150,00	225
3500 14M*	3500,00	250
3850 14M*	3850,00	275
4004 14M*	4004,00	286
4326 14M*	4326,00	309
4578 14M*	4578,00	327

Breite *Standard widths*: 40 mm – Code **40**; 55 mm – Code **55**; 85 mm – Code **85**; 115 mm – Code **115**; 170 mm – Code **170**.

Weitere Abmessungen auf Anfrage. *Further sizes on request.*

* Profil auf Anfrage. * *Section on request.*

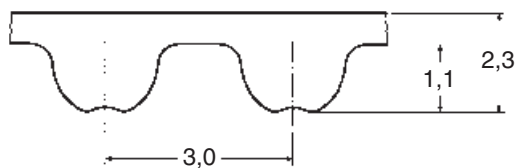

Type 3M HP (nur Mittelwerte nominal dimensions – mm)

Type 3M HP – Teilung *pitch* 3 mm

Artikel- Bezeichnung <i>Designation</i>	Wirklänge <i>Pitch length</i> (mm)	Anzahl der Zähne <i>Number of teeth</i>	Artikel- Bezeichnung <i>Designation</i>	Wirklänge <i>Pitch length</i> (mm)	Anzahl der Zähne <i>Number of teeth</i>
111 3M HP•	111,00	37	537 3M HP•	537,00	179
129 3M HP•	129,00	43	558 3M HP•	558,00	186
141 3M HP•	141,00	47	564 3M HP•	564,00	188
144 3M HP•	144,00	48	570 3M HP•	570,00	190
150 3M HP•	150,00	50	597 3M HP•	597,00	199
165 3M HP•	165,00	55	600 3M HP•	600,00	200
168 3M HP•	168,00	56	606 3M HP•	606,00	202
171 3M HP•	171,00	57	615 3M HP•	615,00	205
174 3M HP•	174,00	58	633 3M HP•	633,00	211
177 3M HP•	177,00	59	669 3M HP•	669,00	223
180 3M HP•	180,00	60	675 3M HP•	675,00	225
183 3M HP•	183,00	61	711 3M HP•	711,00	237
186 3M HP•	186,00	62	738 3M HP•	738,00	246
192 3M HP•	192,00	64	804 3M HP•	804,00	268
195 3M HP•	195,00	65	816 3M HP•	816,00	272
201 3M HP•	201,00	67	843 3M HP•	843,00	281
204 3M HP•	204,00	68	882 3M HP•	882,00	294
207 3M HP•	207,00	69	888 3M HP•	888,00	296
210 3M HP•	210,00	70	1062 3M HP•	1062,00	354
213 3M HP•	213,00	71	1569 3M HP•	1569,00	523
225 3M HP•	225,00	75			
240 3M HP•	240,00	80			
252 3M HP•	252,00	84			
255 3M HP•	255,00	85			
267 3M HP•	267,00	89			
285 3M HP•	285,00	95			
288 3M HP•	288,00	96			
291 3M HP•	291,00	97			
294 3M HP•	294,00	98			
300 3M HP•	300,00	100			
312 3M HP•	312,00	104			
315 3M HP•	315,00	105			
318 3M HP•	318,00	106			
330 3M HP•	330,00	110			
339 3M HP•	339,00	113			
345 3M HP•	345,00	115			
357 3M HP•	357,00	119			
363 3M HP•	363,00	121			
366 3M HP•	366,00	122			
384 3M HP•	384,00	128			
390 3M HP•	390,00	130			
420 3M HP•	420,00	140			
426 3M HP•	426,00	142			
447 3M HP•	447,00	149			
462 3M HP•	462,00	154			
474 3M HP•	474,00	158			
480 3M HP•	480,00	160			
486 3M HP•	486,00	162			
495 3M HP•	495,00	165			
501 3M HP•	501,00	167			
513 3M HP•	513,00	171			
519 3M HP•	519,00	173			
522 3M HP•	522,00	174			
525 3M HP•	525,00	175			
531 3M HP•	531,00	177			

Breite *Standard widths*: 6 mm – Code **6**; 9 mm – Code **9**; 15 mm – Code **15**.

Weitere Abmessungen auf Anfrage. *Further sizes on request.* • Keine Lagerware, Mindestabnahme: 2 Wickel • *Non stock items, minimum order quantity: 2 sleeves*

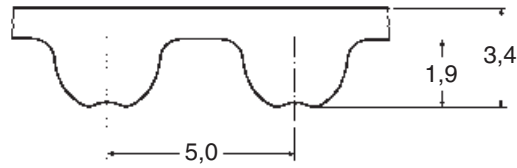

Type 5M HP (nur Mittelwerte nominal dimensions – mm)

Type 5M HP – Teilung *pitch* 5 mm

Artikel- Bezeichnung <i>Designation</i>	Wirklänge <i>Pitch length</i> (mm)	Anzahl der Zähne <i>Number of teeth</i>	Artikel- Bezeichnung <i>Designation</i>	Wirklänge <i>Pitch length</i> (mm)	Anzahl der Zähne <i>Number of teeth</i>
180 5M HP	180,00	36	860 5M HP•	860,00	172
225 5M HP	225,00	45	890 5M HP	890,00	178
255 5M HP	255,00	51	900 5M HP	900,00	180
265 5M HP	265,00	53	925 5M HP	925,00	185
270 5M HP•	270,00	54	935 5M HP•	935,00	187
280 5M HP•	280,00	56	950 5M HP	950,00	190
295 5M HP•	295,00	59	965 5M HP•	965,00	193
305 5M HP	305,00	61	980 5M HP•	980,00	196
325 5M HP•	325,00	65	1000 5M HP	1000,00	200
330 5M HP	330,00	66	1035 5M HP•	1035,00	207
340 5M HP•	340,00	68	1050 5M HP	1050,00	210
350 5M HP	350,00	70	1125 5M HP	1125,00	225
360 5M HP	360,00	72	1135 5M HP•	1135,00	227
365 5M HP•	365,00	73	1200 5M HP•	1200,00	240
370 5M HP•	370,00	74	1270 5M HP•	1270,00	254
375 5M HP	375,00	75	1400 5M HP•	1400,00	280
385 5M HP•	385,00	77	1420 5M HP	1420,00	284
400 5M HP	400,00	80	1425 5M HP•	1425,00	285
415 5M HP•	415,00	83	1500 5M HP•	1500,00	300
425 5M HP	425,00	85	1595 5M HP•	1595,00	319
450 5M HP	450,00	90	1690 5M HP•	1690,00	338
475 5M HP	475,00	95	1790 5M HP•	1790,00	358
490 5M HP•	490,00	98	1870 5M HP•	1870,00	374
500 5M HP	500,00	100	1895 5M HP•	1895,00	379
520 5M HP•	520,00	104	2000 5M HP•	2000,00	400
525 5M HP	525,00	105	2110 5M HP•	2110,00	422
535 5M HP	535,00	107	2350 5M HP•	2350,00	470
540 5M HP•	540,00	108	2525 5M HP•	2525,00	505
550 5M HP	550,00	110			
560 5M HP•	560,00	112			
565 5M HP	565,00	113			
575 5M HP•	575,00	115			
580 5M HP•	580,00	116			
600 5M HP	600,00	120			
610 5M HP•	610,00	122			
615 5M HP•	615,00	123			
630 5M HP	630,00	126			
635 5M HP	635,00	127			
640 5M HP•	640,00	128			
645 5M HP•	645,00	129			
650 5M HP•	650,00	130			
665 5M HP	665,00	133			
670 5M HP•	670,00	134			
700 5M HP	700,00	140			
710 5M HP	710,00	142			
720 5M HP•	720,00	144			
740 5M HP	740,00	148			
750 5M HP•	750,00	150			
755 5M HP	755,00	151			
775 5M HP•	775,00	155			
790 5M HP•	790,00	158			
800 5M HP	800,00	160			
825 5M HP•	825,00	165			
835 5M HP	835,00	167			
850 5M HP•	850,00	170			

Breite *Standard widths*: 9 mm – Code **9**; 15 mm – Code **15**; 25 mm – Code **25**.

Weitere Abmessungen auf Anfrage. *Further sizes on request.* • Keine Lagerware, Mindestabnahme: 2 Wickel. • *Non stock items, minimum order quantity: 2 sleeves.*

(nur Mittelwerte *nominal dimensions* – mm)

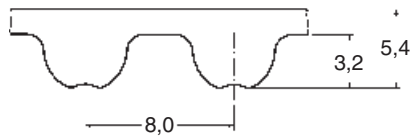

Type 8M HP

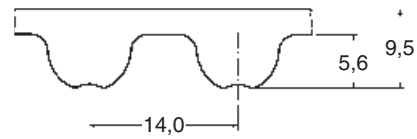

Type 14M HP

Type 8M HP – Teilung pitch 8 mm					
Artikel- Bezeichnung <i>Designation</i>	Wirklänge <i>Pitch length</i> (mm)	Anzahl der Zähne <i>Number of teeth</i>	Artikel- Bezeichnung <i>Designation</i>	Wirklänge <i>Pitch length</i> (mm)	Anzahl der Zähne <i>Number of teeth</i>
352 8M HP•	352,00	44	1680 8M HP•	1680,00	210
424 8M HP	424,00	53	1696 8M HP	1696,00	212
480 8M HP	480,00	60	1728 8M HP•	1728,00	216
512 8M HP•	512,00	64	1760 8M HP	1760,00	220
520 8M HP•	520,00	65	1800 8M HP	1800,00	225
560 8M HP	560,00	70	1904 8M HP•	1904,00	238
576 8M HP•	576,00	72	1936 8M HP	1936,00	242
600 8M HP	600,00	75	2000 8M HP	2000,00	250
608 8M HP•	608,00	76	2080 8M HP•	2080,00	260
632 8M HP•	632,00	79	2104 8M HP•	2104,00	263
640 8M HP	640,00	80	2240 8M HP	2240,00	280
656 8M HP	656,00	82	2248 8M HP	2248,00	281
680 8M HP	680,00	85	2272 8M HP	2272,00	284
712 8M HP•	712,00	89	2400 8M HP	2400,00	300
720 8M HP	720,00	90	2504 8M HP	2504,00	313
760 8M HP	760,00	95	2600 8M HP	2600,00	325
776 8M HP•	776,00	97	2800 8M HP	2800,00	350
784 8M HP•	784,00	98			
800 8M HP	800,00	100			
824 8M HP•	824,00	103			
840 8M HP	840,00	105			
848 8M HP•	848,00	106			
856 8M HP•	856,00	107			
880 8M HP	880,00	110			
896 8M HP•	896,00	112			
912 8M HP•	912,00	114			
920 8M HP	920,00	115			
960 8M HP	960,00	120			
976 8M HP•	976,00	122			
1000 8M HP	1000,00	125			
1040 8M HP	1040,00	130			
1056 8M HP•	1056,00	132			
1064 8M HP	1064,00	133			
1080 8M HP	1080,00	135			
1096 8M HP•	1096,00	137			
			Type 14M HP – Teilung pitch 14 mm		
1120 8M HP	1120,00	140	966 14M HP	966,00	69
1128 8M HP	1128,00	141	1092 14M HP	1092,00	78
1160 8M HP	1160,00	145	1190 14M HP	1190,00	85
1184 8M HP•	1184,00	148	1400 14M HP	1400,00	100
1200 8M HP	1200,00	150	1610 14M HP	1610,00	115
1216 8M HP	1216,00	152	1778 14M HP	1778,00	127
1224 8M HP	1224,00	153	1890 14M HP	1890,00	135
1248 8M HP•	1248,00	156	2100 14M HP	2100,00	150
1256 8M HP•	1256,00	157	2310 14M HP	2310,00	165
1280 8M HP	1280,00	160	2450 14M HP	2450,00	175
1304 8M HP	1304,00	163	2590 14M HP	2590,00	185
1328 8M HP•	1328,00	166	2800 14M HP	2800,00	200
1344 8M HP•	1344,00	168			
1360 8M HP	1360,00	170			
1400 8M HP	1400,00	175			
1424 8M HP	1424,00	178			
1440 8M HP	1440,00	180			
1520 8M HP	1520,00	190			
1552 8M HP	1552,00	194			
1600 8M HP	1600,00	200			

Breite *Standard widths*:

Type 8M HP: 20 mm – Code 20; 30 mm – Code 30;
50 mm – Code 50; 85 mm – Code 85.

Breite *Standard widths*:

Type 14M HP: 40 mm – Code 40; 55 mm – Code 55;
85 mm – Code 85; 115 mm – Code 115; 170 mm – Code 170.

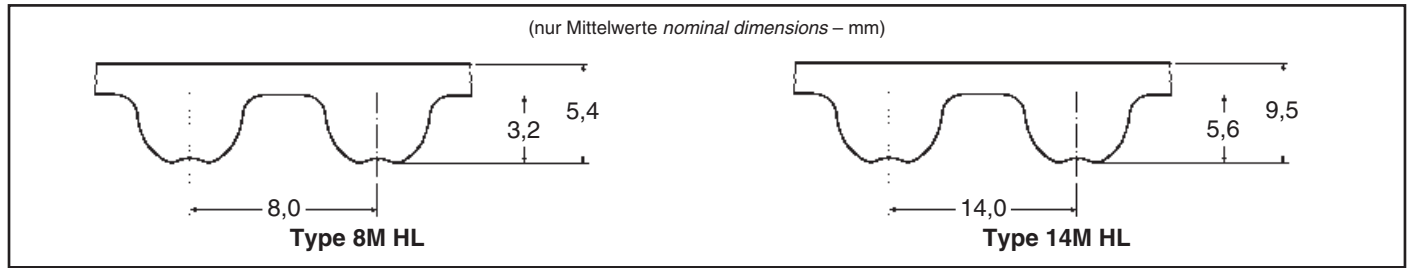

Type 8M HL – Teilung <i>pitch</i> 8 mm					
Artikel- Bezeichnung <i>Designation</i>	Wirklänge <i>Pitch length</i> (mm)	Anzahl der Zähne <i>Number of teeth</i>	Artikel- Bezeichnung <i>Designation</i>	Wirklänge <i>Pitch length</i> (mm)	Anzahl der Zähne <i>Number of teeth</i>
352 8M HL	352,00	44	1800 8M HL	1800,00	225
424 8M HL•	424,00	53	1936 8M HL•	1936,00	242
480 8M HL	480,00	60	2000 8M HL	2000,00	250
560 8M HL	560,00	70	2240 8M HL	2240,00	280
576 8M HL•	576,00	72	2248 8M HL•	2248,00	281
600 8M HL	600,00	75	2272 8M HL•	2272,00	284
608 8M HL	608,00	76	2400 8M HL	2400,00	300
632 8M HL•	632,00	79	2504 8M HL•	2504,00	313
640 8M HL	640,00	80	2600 8M HL	2600,00	325
656 8M HL	656,00	82	2800 8M HL	2800,00	350
680 8M HL•	680,00	85			
712 8M HL•	712,00	89			
720 8M HL	720,00	90			
760 8M HL•	760,00	95			
776 8M HL	776,00	97			
784 8M HL	784,00	98			
800 8M HL	800,00	100			
824 8M HL•	824,00	103			
840 8M HL•	840,00	105			
848 8M HL•	848,00	106			
856 8M HL•	856,00	107			
880 8M HL	880,00	110			
896 8M HL•	896,00	112			
912 8M HL	912,00	114			
920 8M HL	920,00	115			
960 8M HL	960,00	120			
976 8M HL•	976,00	122			
1000 8M HL•	1000,00	125			
1040 8M HL	1040,00	130			
1056 8M HL•	1056,00	132			
1064 8M HL•	1064,00	133			
1080 8M HL•	1080,00	135			
1096 8M HL•	1096,00	137			
1120 8M HL	1120,00	140			
1128 8M HL•	1128,00	141			
1160 8M HL•	1160,00	145			
1184 8M HL•	1184,00	148			
1200 8M HL	1200,00	150			
1216 8M HL•	1216,00	152			
1224 8M HL•	1224,00	153			
1248 8M HL•	1248,00	156			
1280 8M HL	1280,00	160			
1304 8M HL	1304,00	163			
1344 8M HL•	1344,00	168			
1360 8M HL	1360,00	170			
1400 8M HL•	1400,00	175			
1424 8M HL	1424,00	178			
1440 8M HL	1440,00	180			
1520 8M HL•	1520,00	190			
1552 8M HL•	1552,00	194			
1600 8M HL	1600,00	200			
1680 8M HL•	1680,00	210			
1696 8M HL•	1696,00	212			
1728 8M HL•	1728,00	216			
1760 8M HL	1760,00	220			
Type 14M HL – Teilung <i>pitch</i> 14 mm					
			966 14MHL	966,00	69
			1092 14MHL	1092,00	78
			1190 14MHL	1190,00	85
			1400 14MHL	1400,00	100
			1610 14MHL	1610,00	115
			1778 14MHL	1778,00	127
			1890 14MHL	1890,00	135
			2100 14MHL	2100,00	150
			2310 14MHL	2310,00	165
			2450 14MHL	2450,00	175
			2590 14MHL	2590,00	185
			2800 14MHL	2800,00	200

Breite *Standard widths*:

Type 8M HL: 20 mm – Code 20; 30 mm – Code 30;
 50 mm – Code 50; 85 mm – Code 85.

Breite *Standard widths*:

Type 14M HL: 40 mm – Code 40; 55 mm – Code 55;
 85 mm – Code 85; 115 mm – Code 115; 170 mm – Code 170.

Weitere Abmessungen auf Anfrage. *Further sizes on request.* • Keine Lagerware, Mindestabnahme: 2 Wickel. • *Non stock items, minimum order quantity: 2 sleeves.*

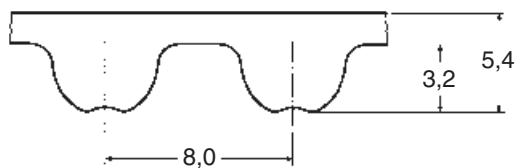

Type 8M (nur Mittelwerte *nominal dimensions* – mm)

Type 8M – Teilung *pitch* 8 mm

Artikel- Bezeichnung <i>Designation</i>	Wirklänge <i>Pitch length</i> (mm)	Anzahl der Zähne <i>Number of teeth</i>
560 8M•	560,00	70
600 8M•	600,00	75
640 8M•	640,00	80
656 8M•	656,00	82
720 8M•	720,00	90
776 8M•	776,00	97
784 8M•	784,00	98
800 8M•	800,00	100
880 8M•	880,00	110
920 8M•	920,00	115
960 8M•	960,00	120
1040 8M•	1040,00	130
1120 8M•	1120,00	140
1200 8M•	1200,00	150
1280 8M•	1280,00	160
1304 8M•	1304,00	163
1328 8M•	1328,00	166
1360 8M•	1360,00	170
1424 8M•	1424,00	178
1440 8M•	1440,00	180
1600 8M•	1600,00	200
1760 8M•	1760,00	220
1800 8M•	1800,00	225
2000 8M•	2000,00	250
2240 8M•	2240,00	280
2248 8M•	2248,00	281
2272 8M•	2272,00	284
2400 8M•	2400,00	300
2600 8M•	2600,00	325
2800 8M•	2800,00	350

Breite *Standard widths*: 20 mm – Code **20**; 30 mm – Code **30**; 50 mm – Code **50**; 85 mm – Code **85**.

Weitere Abmessungen auf Anfrage. *Further sizes on request.* • Keine Lagerware. • *Non stock items.*

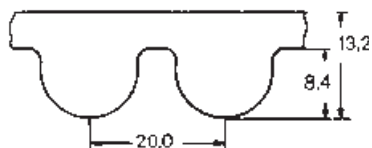

Type 20M (nur Mittelwerte *nominal dimensions* – mm)

Type 20M – Teilung *pitch* 20 mm

Artikel- Bezeichnung <i>Designation</i>	Wirklänge <i>Pitch length</i> (mm)	Anzahl der Zähne <i>Number of teeth</i>
2000 20M•*	2000,00	100
2500 20M•*	2500,00	125
3400 20M•*	3400,00	170
3800 20M•*	3800,00	190
4200 20M•*	4200,00	210
4600 20M•*	4600,00	230
5000 20M•*	5000,00	250
5200 20M•*	5200,00	260
5400 20M•*	5400,00	270
5600 20M•*	5600,00	280
5800 20M•*	5800,00	290
6000 20M•*	6000,00	300
6200 20M•*	6200,00	310
6400 20M•*	6400,00	320
6600 20M•*	6600,00	330

Breite *Standard widths*: 115 mm – Code **115**; 170 mm – Code **170**; 230 mm – Code **230**; 290 mm – Code **290**; 340 mm – Code **340**.

Weitere Abmessungen auf Anfrage. *Further sizes on request.* • Keine Lagerware, Mindestabnahmemenge auf Anfrage. • *Non stock items, minimum order quantity on request.*
* Profil auf Anfrage. * *Section on request.*

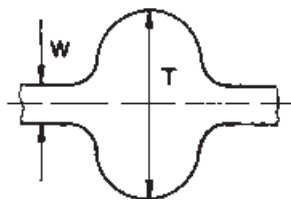

Type	D5M	D8M	D14M
W	1,143	1,372	2,794
T	5,258	8,280	14,834

(nur Mittelwerte *nominal dimensions* – mm)

Type D5M – Teilung <i>pitch</i> 5 mm			Type D8M – Teilung <i>pitch</i> 8 mm			Type D14M – Teilung <i>pitch</i> 14 mm		
Artikel- Bezeichnung <i>Designation</i>	Wirklänge <i>Pitch length</i> (mm)	Anzahl der Zähne <i>Number</i> of teeth	Artikel- Bezeichnung <i>Designation</i>	Wirklänge <i>Pitch length</i> (mm)	Anzahl der Zähne <i>Number</i> of teeth	Artikel- Bezeichnung <i>Designation</i>	Wirklänge <i>Pitch length</i> (mm)	Anzahl der Zähne <i>Number</i> of teeth
565 D5M•	565,00	113	600 D8M•	600,00	75	966 D14M	966,00	69
600 D5M	600,00	120	640 D8M•	640,00	80	1190 D14M	1190,00	85
615 D5M	615,00	123	656 D8M•	656,00	82	1400 D14M	1400,00	100
630 D5M•	630,00	126	720 D8M	720,00	90	1610 D14M	1610,00	115
635 D5M•	635,00	127	776 D8M•	776,00	97	1778 D14M	1778,00	127
665 D5M•	665,00	133	784 D8M	784,00	98	1890 D14M	1890,00	135
700 D5M	700,00	140	800 D8M	800,00	100	2100 D14M	2100,00	150
710 D5M•	710,00	142	880 D8M	880,00	110	2310 D14M	2310,00	165
740 D5M•	740,00	148	920 D8M	920,00	115			
755 D5M	755,00	151	960 D8M	960,00	120			
800 D5M	800,00	160	1040 D8M	1040,00	130			
835 D5M	835,00	167	1120 D8M	1120,00	140			
890 D5M	890,00	178	1200 D8M	1200,00	150			
900 D5M•	900,00	180	1280 D8M	1280,00	160			
925 D5M•	925,00	185	1304 D8M•	1304,00	163			
1000 D5M•	1000,00	200	1328 D8M	1328,00	166			
1050 D5M•	1050,00	210	1360 D8M	1360,00	170			
1125 D5M•	1125,00	225	1424 D8M•	1424,00	178			
1200 D5M•	1200,00	240	1440 D8M	1440,00	180			
			1600 D8M	1600,00	200			
			1760 D8M	1760,00	220			
			1800 D8M	1800,00	225			
			2000 D8M	2000,00	250			
			2400 D8M	2400,00	300			

Breite *Standard widths*:
 9 mm – Code **9**; 15 mm – Code **15**;
 25 mm – Code **25**.

Breite *Standard widths*:
 20 mm – Code **20**; 30 mm – Code **30**;
 50 mm – Code **50**; 85 mm – Code **85**.

Breite *Standard widths*: 40 mm – Code **40**;
 55 mm – Code **55**; 85 mm – Code **85**;
 115 mm – Code **115**; 170 mm – Code **170**.

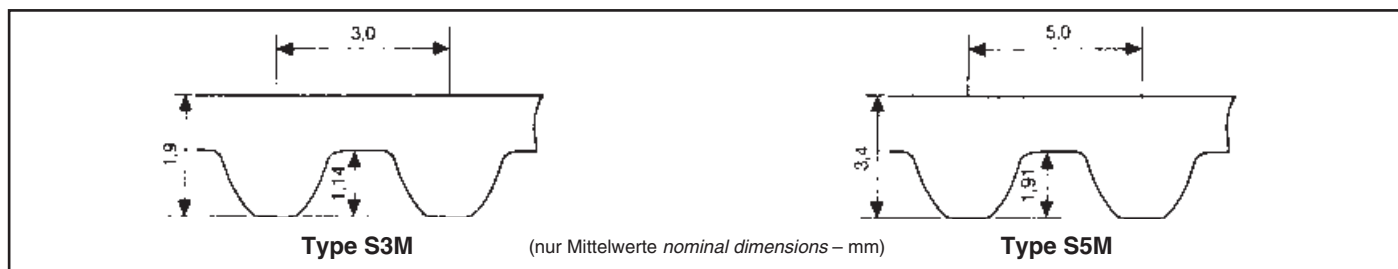

Type S3M – Teilung <i>pitch</i> 3 mm			Type S5M – Teilung <i>pitch</i> 5 mm		
Artikel- Bezeichnung <i>Designation</i>	Wirklänge <i>Pitch length</i> (mm)	Anzahl der Zähne <i>Number of teeth</i>	Artikel- Bezeichnung <i>Designation</i>	Wirklänge <i>Pitch length</i> (mm)	Anzahl der Zähne <i>Number of teeth</i>
S3M 120*	120,00	40	S5M 255*	255,00	51
S3M 150*	150,00	50	S5M 295*	295,00	59
S3M 177*	177,00	59	S5M 325*	325,00	65
S3M 201*	201,00	67	S5M 350*	350,00	70
S3M 225*	225,00	75	S5M 375*	375,00	75
S3M 252*	252,00	84	S5M 400*	400,00	80
S3M 264*	264,00	88	S5M 425*	425,00	85
S3M 276*	276,00	92	S5M 475*	475,00	95
S3M 300*	300,00	100	S5M 500*	500,00	100
S3M 339*	339,00	113	S5M 525*	525,00	105
S3M 384*	384,00	128	S5M 560*	560,00	112
S3M 420*	420,00	140	S5M 575*	575,00	115
S3M 459*	459,00	153	S5M 600*	600,00	120
S3M 486*	486,00	162	S5M 625*	625,00	125
S3M 501*	501,00	167	S5M 650*	650,00	130
S3M 537*	537,00	179	S5M 675*	675,00	135
S3M 564*	564,00	188	S5M 700*	700,00	140
S3M 633*	633,00	211	S5M 750*	750,00	150
			S5M 800*	800,00	160
			S5M 850*	850,00	170
			S5M 900*	900,00	180
			S5M 950*	950,00	190
			S5M 1000*	1000,00	200
			S5M 1050*	1050,00	210
			S5M 1125*	1125,00	225
			S5M 1270*	1270,00	254
			S5M 1350*	1350,00	270
			S5M 1420*	1420,00	284
			S5M 1800*	1800,00	360
			S5M 2000*	2000,00	400

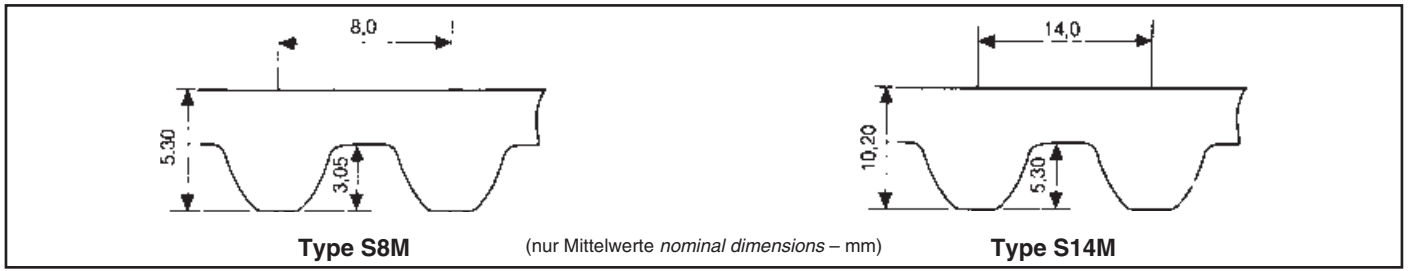

Type S8M – Teilung <i>pitch</i> 8 mm						Type S14M – Teilung <i>pitch</i> 14 mm		
Artikel- Bezeichnung Designation	Wirklänge Pitch length (mm)	Anzahl der Zähne Num- ber of teeth	Artikel- Bezeichnung Designation	Wirklänge Pitch length (mm)	Anzahl der Zähne Number of teeth	Artikel- Bezeichnung Designation	Wirklänge Pitch length (mm)	Anzahl der Zähne Number of teeth
S8M 440	440,00	55	S8M 1360	1360,00	170	S14M 1400	1400,00	100
S8M 480	480,00	60	S8M 1400	1400,00	175	S14M 1540	1540,00	110
S8M 560	560,00	70	S8M 1408•	1408,00	176	S14M 1610	1610,00	115
S8M 600	600,00	75	S8M 1440	1440,00	180	S14M 1890	1890,00	135
S8M 632	632,00	7	S8M 1480	1480,00	185	S14M 2002	2002,00	143
S8M 640	640,00	80	S8M 1600	1600,00	200	S14M 2100•	2100,00	150
S8M 656	656,00	82	S8M 1760	1760,00	220	S14M 2240	2240,00	160
S8M 688	688,00	86	S8M 1776•	1776,00	222	S14M 2310•	2310,00	165
S8M 696•	696,00	87	S8M 1800	1800,00	225	S14M 2450•	2450,00	175
S8M 712	712,00	89	S8M 1816	1816,00	227	S14M 2590•	2590,00	185
S8M 720	720,00	90	S8M 1912•	1912,00	239	S14M 2800	2800,00	200
S8M 728	728,00	91	S8M 2000	2000,00	250	S14M 3150•	3150,00	225
S8M 736•	736,00	92	S8M 2240	2240,00	280	S14M 3500•	3500,00	250
S8M 760	760,00	95	S8M 2392•	2392,00	299	S14M 3850•	3850,00	275
S8M 768	768,00	96	S8M 2400•	2400,00	300	S14M 4004•	4004,00	286
S8M 784•	784,00	98	S8M 2496•	2496,00	312	S14M 4508•	4508,00	322
S8M 792•	792,00	99	S8M 2800•	2800,00	350	S14M 5012•	5012,00	358
S8M 800	800,00	100	S8M 3200	3200,00	400			
S8M 824	824,00	103						
S8M 848	848,00	106						
S8M 864•	864,00	108						
S8M 880	880,00	110						
S8M 896	896,00	112						
S8M 912	912,00	114						
S8M 920	920,00	115						
S8M 944	944,00	118						
S8M 960	960,00	120						
S8M 992•	992,00	124						
S8M 1000	1000,00	125						
S8M 1024•	1024,00	128						
S8M 1032	1032,00	129						
S8M 1040	1040,00	130						
S8M 1056	1056,00	132						
S8M 1064•	1064,00	133						
S8M 1072•	1072,00	134						
S8M 1120	1120,00	140						
S8M 1136	1136,00	142						
S8M 1152	1152,00	144						
S8M 1160	1160,00	145						
S8M 1168	1168,00	146						
S8M 1176•	1176,00	147						
S8M 1184	1184,00	148						
S8M 1192	1192,00	149						
S8M 1200	1200,00	150						
S8M 1208•	1208,00	151						
S8M 1216•	1216,00	152						
S8M 1240	1240,00	155						
S8M 1248	1248,00	156						
S8M 1256	1256,00	157						
S8M 1264•	1264,00	158						
S8M 1280	1280,00	160						
S8M 1304	1304,00	163						
S8M 1312	1312,00	164						
S8M 1344	1344,00	168						
S8M 1352	1352,00	169						

Breite *Standard widths*:
20 mm – Code **200**; 30 mm – Code **300**; 50 mm – Code **500**; 85 mm – Code **850**.

Breite *Standard widths*: 40 mm – Code **400**;
55 mm – Code **550**; 85 mm – Code **850**;
115 mm – Code **1150**; 170 mm – Code **1700**.

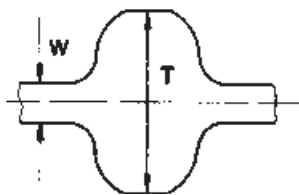

Type	DS8M
W	1,372
T	7,500

(nur Mittelwerte nominal dimensions – mm)

Type DS8M – Teilung *pitch* 8 mm

Artikel- Bezeichnung <i>Designation</i>	Wirklänge <i>Pitch length</i> (mm)	Anzahl der Zähne <i>Number of teeth</i>
DS8M 1160•	1160,00	145
DS8M 1168•	1168,00	146
DS8M 1176•	1176,00	147
DS8M 1184•	1184,00	148
DS8M 1200•	1200,00	150
DS8M 1216•	1216,00	152
DS8M 1240•	1240,00	155
DS8M 1256•	1256,00	157
DS8M 1264•	1264,00	158
DS8M 1280•	1280,00	160
DS8M 1304•	1304,00	163
DS8M 1312•	1312,00	164
DS8M 1344•	1344,00	168
DS8M 1400•	1400,00	175
DS8M 1408•	1408,00	176
DS8M 1440•	1440,00	180
DS8M 1480•	1480,00	185
DS8M 1600•	1600,00	200
DS8M 1760•	1760,00	220
DS8M 1776•	1776,00	222

Breite *Standard widths*:

20 mm – Code **200**; 30 mm – Code **300**; 50 mm – Code **500**; 85 mm – Code **850**.

optibelt ZR linear Endliche Zahnflachriemen aus Chloropren
Open-Ended Timing Belts made from Chloroprene

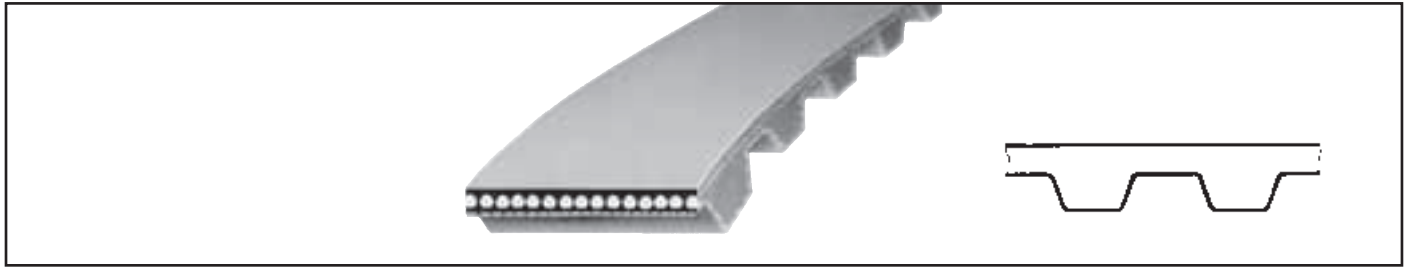

Glasfaserzugstrang <i>Glass fibre cord</i>			Stahlzugstrang <i>Steel wire cord</i>		
Artikel-Bezeichnung <i>Type</i>	Riemenbreite <i>Belt width</i> (mm)	Rollenlänge <i>Length of roll</i> (Meter metre)	Artikel-Bezeichnung <i>Type</i>	Riemenbreite <i>Belt width</i> (mm)	Rollenlänge <i>Length of roll</i> (Meter metre)
MXL 025•	6,35	30	XL 025 - St•	6,35	30
XL 025	6,35	30	XL 031 - St•	7,94	30
XL 031•	7,94	30	XL 037 - St•	9,53	30
XL 037	9,53	30	XL 050 - St•	12,70	30
XL 050	12,70	30	L 037 - St•	9,53	30
L 037	9,53	30	L 050 - St•	12,70	30
L 050	12,70	30	L 075 - St•	19,05	30
L 075	19,05	30	L 100 - St•	25,40	30
L 100	25,40	30	H 050 - St•	12,70	30
H 050	12,70	30	H 075 - St•	19,05	30
H 075	19,05	30	H 100 - St•	25,40	30
H 100	25,40	30	H 150 - St•	38,10	30
H 150•	38,10	30	H 200 - St•	50,80	30
H 200•	50,80	30			

optibelt HTD® linear Endliche Zahnflachriemen aus Chloropren
Open-Ended Timing Belts made from Chloroprene



Glasfaserzugstrang <i>Glass fibre cord</i>			Stahlzugstrang <i>Steel wire cord</i>		
Artikel-Bezeichnung <i>Type</i>	Riemenbreite <i>Belt width</i> (mm)	Rollenlänge <i>Length of roll</i> (Meter metre)	Artikel-Bezeichnung <i>Type</i>	Riemenbreite <i>Belt width</i> (mm)	Rollenlänge <i>Length of roll</i> (Meter metre)
3M 06•	6,0	30	3M 06 - St•	6,0	30
3M 09•	9,0	30	3M 09 - St•	9,0	30
3M 15•	15,0	30	3M 15 - St•	15,0	30
5M 06•	6,0	30	5M 06 - St•	6,0	30
5M 09•	9,0	30	5M 09 - St•	9,0	30
5M 15•	15,0	30	5M 15 - St•	15,0	30
5M 25•	25,0	30	5M 25 - St•	25,0	30
8M 10•	10,0	30	8M 10 - St•	10,0	30
8M 15•	15,0	30	8M 15 - St•	15,0	30
8M 20•	20,0	30	8M 20 - St•	20,0	30
8M 30•	30,0	30	8M 30 - St•	30,0	30
8M 50•	50,0	30	8M 50 - St•	50,0	30
8M 85•	85,0	30	8M 85 - St•	85,0	30
14M 25•	25,0	30	14M 25 - St•	25,0	30
14M 40•	40,0	30	14M 40 - St•	40,0	30
14M 55•	55,0	30	14M 55 - St•	55,0	30
14M 85•	85,0	30	14M 85 - St•	85,0	30

Weitere Abmessungen sowie endliche Zahnflachriemen mit Winkelabweichung auf Anfrage.
Further sizes and open-ended timing belts with angular deflection on request.

• Keine Lagerware.
 • *Non stock items.*

Mindestabnahmemenge auf Anfrage.
Minimum order quantity on request.

optibelt OMEGA linear Endliche Zahnflachriemen aus Chloropren
Open-Ended Timing Belts made from Chloroprene

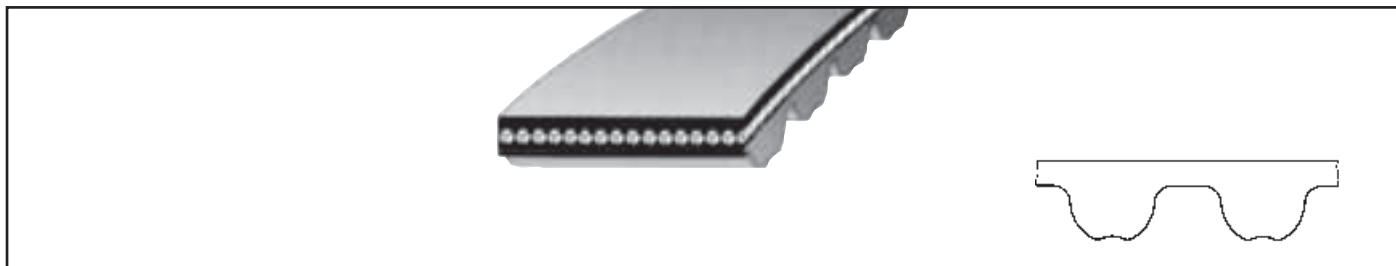

Glasfaserzugstrang Glass fibre cord

Artikel-Bezeichnung Type	Riemenbreite Belt width (mm)	Rollenlänge Length of roll (Meter metre)
3M 09	9,0	30
5M 10	10,0	30
5M 15	15,0	30
5M 25	25,0	30
8M 10	10,0	30
8M 15	15,0	30
8M 20	20,0	30
8M 25	25,0	30

optibelt OMEGA HP linear Endliche Zahnflachriemen aus Chloropren
Open-Ended Timing Belts made from Chloroprene

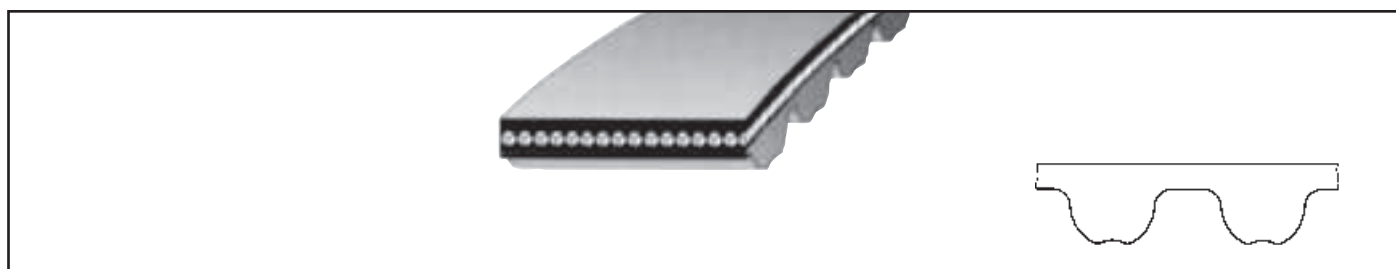

Glasfaserzugstrang Glass fibre cord

Artikel-Bezeichnung Type	Riemenbreite Belt width (mm)	Rollenlänge Length of roll (Meter metre)
3M HP 09•	9,0	30
5M HP 10•	10,0	30
5M HP 15•	15,0	30
5M HP 25•	25,0	30
8M HP 10•	10,0	30
8M HP 15•	15,0	30
8M HP 20•	20,0	30
8M HP 25•	25,0	30

Weitere Abmessungen sowie endliche Zahnflachriemen mit Winkelabweichung auf Anfrage.
 Further sizes and open-ended timing belts with angular deflection on request.

• Keine Lagerware.
 • Non stock items.

Mindestabnahmemenge auf Anfrage.
 Minimum order quantity on request.

Zahnflachriemen Polyurethan

Timing Belts Polyurethane

optibelt



optibelt ALPHA



optibelt ALPHA linear/V



optibelt ALPHAflex

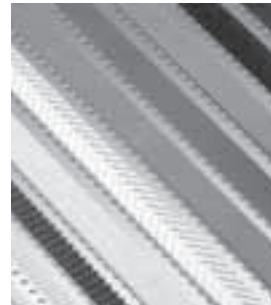

optibelt ALPHA Spezial



optibelt ALPHA Spezial



optibelt ALPHA SRP

Aufbau: Polyurethan mit Stahlzugstrang
Construction: Polyurethane with steel wire cord

Type	t (mm)	ht (mm)	hs (mm)	s (mm)	β
T2,5	2,5	0,70	1,30	1,50	40°
T5	5,0	1,20	2,20	2,65	40°

T2,5
 10 T2,5 / 120
 Wirklänge Pitch length (mm)
 Teilung Pitch (2,5 mm)
 Breite Width (mm)

Type T2,5 – Teilung pitch 2,5 mm			Type T5 – Teilung pitch 5 mm					
Artikel-Bezeichnung Designation	Wirklänge Pitch length (mm)	Anzahl der Zähne Number of teeth	Artikel-Bezeichnung Designation	Wirklänge Pitch length (mm)	Anzahl der Zähne Number of teeth	Artikel-Bezeichnung Designation	Wirklänge Pitch length (mm)	Anzahl der Zähne Number of teeth
T2,5/120	120,00	48	T5/165	165,00	33	T5/ 690	690,00	138
T2,5/145	145,00	58	T5/185	185,00	37	T5/ 700	700,00	140
T2,5/160	160,00	64	T5/200	200,00	40	T5/ 720	720,00	144
T2,5/177,5	177,50	71	T5/215	215,00	43	T5/ 725	725,00	145
T2,5/180	180,00	72	T5/220	220,00	44	T5/ 750	750,00	150
T2,5/200	200,00	80	T5/225	225,00	45	T5/ 780	780,00	156
T2,5/210	210,00	84	T5/245	245,00	49	T5/ 800	800,00	160
T2,5/230	230,00	92	T5/250	250,00	50	T5/ 815	815,00	163
T2,5/245	245,00	98	T5/255	255,00	51	T5/ 840	840,00	168
T2,5/265	265,00	106	T5/260	260,00	52	T5/ 850	850,00	170
T2,5/277,5	277,50	111	T5/270	270,00	54	T5/ 860	860,00	172
T2,5/285	285,00	114	T5/275	275,00	55	T5/ 900	900,00	180
T2,5/290	290,00	116	T5/280	280,00	56	T5/ 940	940,00	188
T2,5/305	305,00	122	T5/295	295,00	59	T5/ 990	990,00	198
T2,5/317,5	317,50	127	T5/300	300,00	60	T5/1000	1000,00	200
T2,5/330	330,00	132	T5/305	305,00	61	T5/1075	1075,00	215
T2,5/342,5	342,50	137	T5/320	320,00	64	T5/1100	1100,00	220
T2,5/380	380,00	152	T5/325	325,00	65	T5/1115	1115,00	223
T2,5/420	420,00	168	T5/330	330,00	66	T5/1140	1140,00	228
T2,5/480	480,00	192	T5/340	340,00	68	T5/1215	1215,00	243
T2,5/500	500,00	200	T5/350	350,00	70	T5/1315	1315,00	263
T2,5/540	540,00	216	T5/355	355,00	71	T5/1350	1350,00	270
T2,5/600	600,00	240	T5/360	360,00	72	T5/1380	1380,00	276
T2,5/650	650,00	260	T5/365	365,00	73	T5/1440	1440,00	288
T2,5/780	780,00	312	T5/375	375,00	75			
T2,5/915	915,00	366	T5/390	390,00	78			
T2,5/950	950,00	380	T5/400	400,00	80			
			T5/410	410,00	82			
			T5/420	420,00	84			
			T5/425	425,00	85			
			T5/430	430,00	86			
			T5/440	440,00	88			
			T5/445	445,00	89			
			T5/450	450,00	90			
			T5/455	455,00	91			
			T5/460	460,00	92			
			T5/475	475,00	95			
			T5/480	480,00	96			
			T5/500	500,00	100			
			T5/510	510,00	102			
			T5/525	525,00	105			
			T5/545	545,00	109			
			T5/550	550,00	110			
			T5/560	560,00	112			
			T5/575	575,00	115			
			T5/590	590,00	118			
			T5/600	600,00	120			
			T5/610	610,00	122			
			T5/620	620,00	124			
			T5/625	625,00	125			
			T5/630	630,00	126			
			T5/640	640,00	128			
			T5/650	650,00	130			
			T5/660	660,00	132			
			T5/675	675,00	135			

Breite Standard widths:
4 mm – Code 4; 6 mm – Code 6; 8 mm – Code 8;
10 mm – Code 10; 12 mm – Code 12.

Breite Standard widths:
6 mm – Code 6; 8 mm – Code 8; 10 mm – Code 10; 12 mm – Code 12; 16 mm – Code 16;
20 mm – Code 20; 25 mm – Code 25.

T10

10 T10 / 260

Wirklänge Pitch length (mm)

Teilung Pitch (10 mm)

Breite Width (mm)

Type	t (mm)	ht (mm)	hs (mm)	s (mm)	β
T10	10,0	2,50	4,50	5,30	40°

Aufbau: Polyurethan mit Stahlzugstrang
Construction: Polyurethane with steel wire cord

Type T10 – Teilung pitch 10 mm

Artikel-Bezeichnung Designation	Wirklänge Pitch length (mm)	Anzahl der Zähne Number of teeth	Artikel-Bezeichnung Designation	Wirklänge Pitch length (mm)	Anzahl der Zähne Number of teeth
T10/ 260	260,00	26	T10/1460	1460,00	146
T10/ 320	320,00	32	T10/1500	1500,00	150
T10/ 350	350,00	35	T10/1560	1560,00	156
T10/ 370	370,00	37	T10/1600	1600,00	160
T10/ 400	400,00	40	T10/1610	1610,00	161
T10/ 410	410,00	41	T10/1700	1700,00	170
T10/ 440	440,00	44	T10/1750	1750,00	175
T10/ 450	450,00	45	T10/1780	1780,00	178
T10/ 500	500,00	50	T10/1800	1800,00	180
T10/ 530	530,00	53	T10/1880	1880,00	188
T10/ 550	550,00	55	T10/1960	1960,00	196
T10/ 560	560,00	56	T10/2250	2250,00	225
T10/ 600	600,00	60			
T10/ 610	610,00	61			
T10/ 630	630,00	63			
T10/ 650	650,00	65			
T10/ 660	660,00	66			
T10/ 690	690,00	69			
T10/ 700	700,00	70			
T10/ 720	720,00	72			
T10/ 750	750,00	75			
T10/ 780	780,00	78			
T10/ 800	800,00	80			
T10/ 810	810,00	81			
T10/ 840	840,00	84			
T10/ 850	850,00	85			
T10/ 880	880,00	88			
T10/ 890	890,00	89			
T10/ 900	900,00	90			
T10/ 910	910,00	91			
T10/ 920	920,00	92			
T10/ 950	950,00	95			
T10/ 960	960,00	96			
T10/ 970	970,00	97			
T10/ 980	980,00	98			
T10/1000	1000,00	100			
T10/1010	1010,00	101			
T10/1050	1050,00	105			
T10/1080	1080,00	108			
T10/1100	1100,00	110			
T10/1110	1110,00	111			
T10/1140	1140,00	114			
T10/1150	1150,00	115			
T10/1200	1200,00	120			
T10/1210	1210,00	121			
T10/1240	1240,00	124			
T10/1250	1250,00	125			
T10/1300	1300,00	130			
T10/1320	1320,00	132			
T10/1350	1350,00	135			
T10/1390	1390,00	139			
T10/1400	1400,00	140			
T10/1420	1420,00	142			
T10/1440	1440,00	144			
T10/1450	1450,00	145			

Breite Standard widths:
10 mm – Code 10; 12 mm – Code 12; 16 mm – Code 16; 20 mm – Code 20; 25 mm – Code 25; 32 mm – Code 32; 50 mm – Code 50.

Weitere Abmessungen auf Anfrage. Further sizes on request.

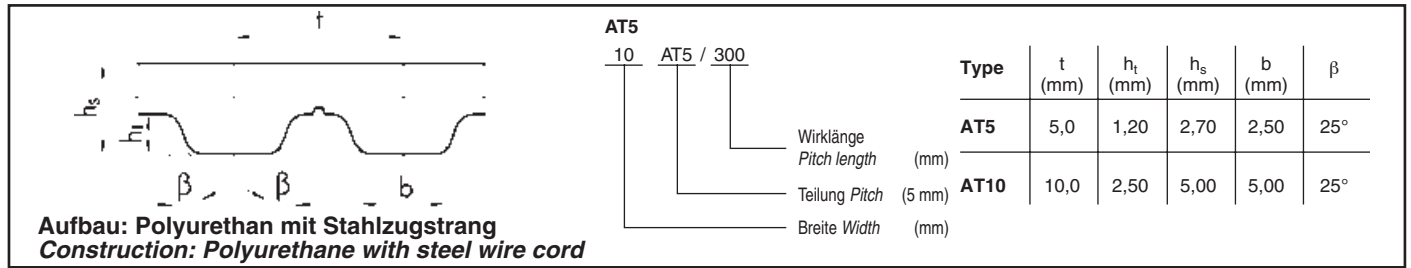

Type AT5 – Teilung <i>pitch</i> 5 mm			Type AT10 – Teilung <i>pitch</i> 10 mm		
Artikel- Bezeichnung Designation	Wirklänge Pitch length (mm)	Anzahl der Zähne Number of teeth	Artikel- Bezeichnung Designation	Wirklänge Pitch length (mm)	Anzahl der Zähne Number of teeth
AT5/ 225	225,00	45	AT10/ 500	500,00	50
AT5/ 255	255,00	51	AT10/ 530	530,00	53
AT5/ 280	280,00	56	AT10/ 560	560,00	56
AT5/ 300	300,00	60	AT10/ 600	600,00	60
AT5/ 340	340,00	68	AT10/ 610	610,00	61
AT5/ 375	375,00	75	AT10/ 660	660,00	66
AT5/ 390	390,00	78	AT10/ 700	700,00	70
AT5/ 420	420,00	84	AT10/ 730	730,00	73
AT5/ 450	450,00	90	AT10/ 780	780,00	78
AT5/ 455	455,00	91	AT10/ 800	800,00	80
AT5/ 500	500,00	100	AT10/ 840	840,00	84
AT5/ 545	545,00	109	AT10/ 890	890,00	89
AT5/ 600	600,00	120	AT10/ 920	920,00	92
AT5/ 610	610,00	122	AT10/ 960	960,00	96
AT5/ 660	660,00	132	AT10/ 980	980,00	98
AT5/ 710	710,00	142	AT10/1000	1000,00	100
AT5/ 720	720,00	144	AT10/1010	1010,00	101
AT5/ 750	750,00	150	AT10/1050	1050,00	105
AT5/ 780	780,00	156	AT10/1080	1080,00	108
AT5/ 825	825,00	165	AT10/1100	1100,00	110
AT5/ 860	860,00	172	AT10/1150	1150,00	115
AT5/ 975	975,00	195	AT10/1200	1200,00	120
AT5/1050	1050,00	210	AT10/1210	1210,00	121
AT5/1125	1125,00	225	AT10/1250	1250,00	125
AT5/1500	1500,00	300	AT10/1280	1280,00	128
			AT10/1300	1300,00	130
			AT10/1320	1320,00	132
			AT10/1350	1350,00	135
			AT10/1360	1360,00	136
			AT10/1400	1400,00	140
			AT10/1420	1420,00	142
			AT10/1480	1480,00	148
			AT10/1500	1500,00	150
			AT10/1600	1600,00	160
			AT10/1700	1700,00	170
			AT10/1720	1720,00	172
			AT10/1800	1800,00	180
			AT10/1860	1860,00	186
			AT10/1940	1940,00	194

Breite *Standard widths*:
 6 mm – Code **6**; 8 mm – Code **8**; 10 mm – Code **10**; 12 mm – Code **12**;
 16 mm – Code **16**; 20 mm – Code **20**; 25 mm – Code **25**.

Breite *Standard widths*:
 10 mm – Code **10**; 12 mm – Code **12**; 16 mm – Code **16**; 20 mm – Code **20**;
 25 mm – Code **25**; 32 mm – Code **32**; 50 mm – Code **50**.

DT5/DT10

25 DT5 / 300

Wirklänge Pitch length (mm)

Teilung Pitch (5 mm)

Doppel-Zahnflachriemen Double timing belts

Breite Width (mm)

Type	t (mm)	h _t (mm)	h _{s1} (mm)	s (mm)	β
DT5	5,0	1,20	3,40	2,65	40°
DT10	10,0	2,50	7,00	5,30	40°

Aufbau: Polyurethan mit Stahlzugstrang
Construction: Polyurethane with steel wire cord

Type DT5 – Teilung <i>pitch</i> 5 mm			Type DT10 – Teilung <i>pitch</i> 10 mm		
Artikel-Bezeichnung <i>Designation</i>	Wirklänge <i>Pitch length</i> (mm)	Anzahl der Zähne <i>Number of teeth</i>	Artikel-Bezeichnung <i>Designation</i>	Wirklänge <i>Pitch length</i> (mm)	Anzahl der Zähne <i>Number of teeth</i>
DT5/ 300	300,00	60	DT10/ 260	260,00	26
DT5/ 350•	350,00	70	DT10/ 530	530,00	53
DT5/ 400•	400,00	80	DT10/ 600	600,00	60
DT5/ 410	410,00	82	DT10/ 630	630,00	63
DT5/ 450•	450,00	90	DT10/ 660	660,00	66
DT5/ 460	460,00	92	DT10/ 700	700,00	70
DT5/ 480	480,00	96	DT10/ 720	720,00	72
DT5/ 500	500,00	100	DT10/ 750	750,00	75
DT5/ 515	515,00	103	DT10/ 800	800,00	80
DT5/ 550	550,00	110	DT10/ 840	840,00	84
DT5/ 590	590,00	118	DT10/ 900	900,00	90
DT5/ 600	600,00	120	DT10/ 980	980,00	98
DT5/ 620	620,00	124	DT10/1000•	1000,00	100
DT5/ 650	650,00	130	DT10/1100	1100,00	110
DT5/ 700	700,00	140	DT10/1200•	1200,00	120
DT5/ 750	750,00	150	DT10/1210	1210,00	121
DT5/ 800	800,00	160	DT10/1240	1240,00	124
DT5/ 815	815,00	163	DT10/1250	1250,00	125
DT5/ 860	860,00	172	DT10/1300•	1300,00	130
DT5/ 900	900,00	180	DT10/1320	1320,00	132
DT5/ 940	940,00	188	DT10/1350	1350,00	135
DT5/1100	1100,00	220	DT10/1400	1400,00	140
			DT10/1420	1420,00	142
			DT10/1500	1500,00	150
			DT10/1600•	1600,00	160
			DT10/1610	1610,00	161
			DT10/1700	1700,00	170
			DT10/1800	1800,00	180
			DT10/1880	1880,00	188

Breite *Standard widths*:
 6 mm – Code **6**; 8 mm – Code **8**; 10 mm – Code **10**; 12 mm – Code **12**;
 16 mm – Code **16**; 20 mm – Code **20**; 25 mm – Code **25**; 32 mm – Code **32**.

Breite *Standard widths*:
 10 mm – Code **10**; 12 mm – Code **12**; 16 mm – Code **16**; 20 mm – Code **20**;
 25 mm – Code **25**; 32 mm – Code **32**; 50 mm – Code **50**.

Weitere Abmessungen sowie Sonderausführungen auf Anfrage. *Further sizes and special constructions on request.*

• Keine Lagerware. • *Non stock items.*

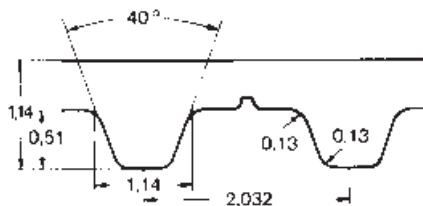

Aufbau:
Polyurethan mit Aramidzugstrang
Construction:
Polyurethane with Aramid tension cord

Type MXL (nur Mittelwerte nominal dimensions – mm)

Type MXL – Teilung pitch 2,032 mm

Artikel- Bezeichnung Designation	Wirklänge Pitch length		Anzahl der Zähne Number of teeth	Artikel- Bezeichnung Designation	Wirklänge Pitch length		Anzahl der Zähne Number of teeth
	(Zoll inch)	(mm)			(Zoll inch)	(mm)	
K 240 MXL•	2,40	60,96	30	K 2480 MXL•	24,80	629,92	310
K 280 MXL•	2,80	71,12	35	K 2560 MXL•	25,60	650,24	320
K 320 MXL•	3,20	81,28	40	K 2640 MXL•	26,40	670,56	330
K 360 MXL•	3,60	91,44	45	K 2720 MXL•	27,20	690,88	340
K 400 MXL•	4,00	101,60	50	K 2800 MXL•	28,00	711,20	350
K 440 MXL•	4,40	111,76	55	K 2880 MXL•	28,80	731,52	360
K 480 MXL•	4,80	121,92	60	K 2960 MXL•	29,60	751,84	370
K 520 MXL•	5,20	132,08	65	K 3040 MXL•	30,40	772,16	380
K 560 MXL•	5,60	142,24	70	K 3120 MXL•	31,20	792,48	390
K 600 MXL•	6,00	152,40	75	K 3200 MXL•	32,00	812,80	400
K 640 MXL•	6,40	162,56	80				
K 680 MXL•	6,80	172,72	85				
K 720 MXL•	7,20	182,88	90				
K 760 MXL•	7,60	193,04	95				
K 800 MXL•	8,00	203,20	100				
K 840 MXL•	8,40	213,36	105				
K 880 MXL•	8,80	223,52	110				
K 920 MXL•	9,20	233,68	115				
K 960 MXL•	9,60	243,84	120				
K 1000 MXL•	10,00	254,00	125				
K 1040 MXL•	10,40	264,16	130				
K 1080 MXL•	10,80	274,32	135				
K 1120 MXL•	11,20	284,48	140				
K 1160 MXL•	11,60	294,64	145				
K 1200 MXL•	12,00	304,80	150				
K 1240 MXL•	12,40	314,96	155				
K 1280 MXL•	12,80	325,12	160				
K 1320 MXL•	13,20	335,28	165				
K 1360 MXL•	13,60	345,44	170				
K 1400 MXL•	14,00	355,60	175				
K 1440 MXL•	14,40	365,76	180				
K 1480 MXL•	14,80	375,92	185				
K 1520 MXL•	15,20	386,08	190				
K 1560 MXL•	15,60	396,24	195				
K 1600 MXL•	16,00	406,40	200				
K 1640 MXL•	16,40	416,56	205				
K 1680 MXL•	16,80	426,72	210				
K 1720 MXL•	17,20	436,88	215				
K 1760 MXL•	17,60	447,04	220				
K 1800 MXL•	18,00	457,20	225				
K 1840 MXL•	18,40	467,36	230				
K 1880 MXL•	18,80	477,52	235				
K 1920 MXL•	19,20	487,68	240				
K 1960 MXL•	19,60	497,84	245				
K 2000 MXL•	20,00	508,00	250				
K 2040 MXL•	20,40	518,16	255				
K 2080 MXL•	20,80	528,32	260				
K 2120 MXL•	21,20	538,48	265				
K 2160 MXL•	21,60	548,64	270				
K 2200 MXL•	22,00	558,80	275				
K 2240 MXL•	22,40	568,96	280				
K 2280 MXL•	22,80	579,12	285				
K 2320 MXL•	23,20	589,28	290				
K 2360 MXL•	23,60	599,44	295				
K 2400 MXL•	24,00	609,60	300				

Breite Standard widths:
 1/8" – Code 012; 3/16" – Code 019; 1/4" – Code 025; 5/16" – Code 031.

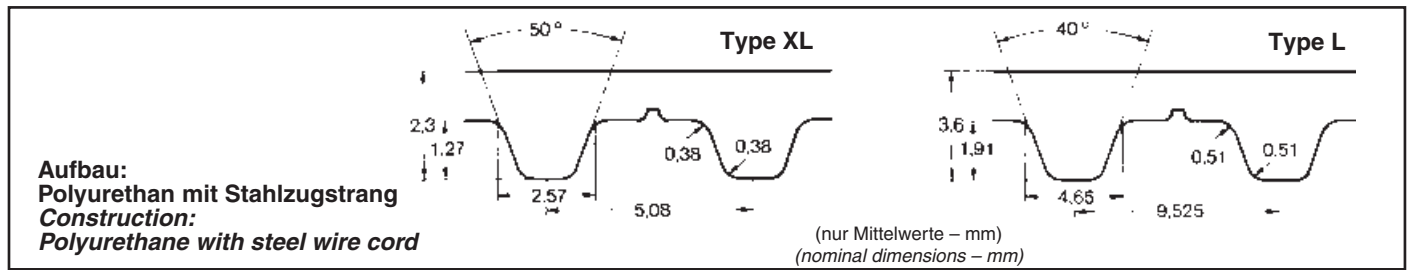

Type XL – Teilung <i>pitch</i> 5,08 mm				Type L – Teilung <i>pitch</i> 9,525 mm			
Artikel- Bezeichnung <i>Designation</i>	Wirklänge <i>Pitch length</i>		Anzahl der Zähne <i>Number of teeth</i>	Artikel- Bezeichnung <i>Designation</i>	Wirklänge <i>Pitch length</i>		Anzahl der Zähne <i>Number of teeth</i>
	(Zoll <i>inch</i>)	(mm)			(Zoll <i>inch</i>)	(mm)	
K 60 XL•	6,00	152,40	30	K 124 L	12,38	314,33	33
K 70 XL•	7,00	177,80	35	K 150 L	15,00	381,00	40
K 76 XL•	7,60	193,04	38	K 165 L•	16,50	419,10	44
K 80 XL•	8,00	203,20	40	K 173 L•	17,25	438,15	46
K 84 XL•	8,40	213,36	42	K 187 L	18,75	476,25	50
K 90 XL•	9,00	228,60	45	K 210 L	21,00	533,40	56
K 94 XL•	9,40	238,76	47	K 225 L	22,50	571,50	60
K 96 XL•	9,60	243,84	48	K 240 L	24,00	609,60	64
K 100 XL	10,00	254,00	50	K 255 L	25,50	647,70	68
K 102 XL•	10,20	259,08	51	K 270 L	27,00	685,80	72
K 104 XL	10,40	264,16	52	K 285 L	28,50	723,90	76
K 106 XL•	10,60	269,24	53	K 300 L	30,00	762,00	80
K 110 XL	11,00	279,40	55	K 322 L	32,25	819,15	86
K 114 XL•	11,40	289,56	57	K 345 L	34,50	876,30	92
K 116 XL•	11,60	294,64	58	K 367 L	36,75	933,45	98
K 120 XL	12,00	304,80	60	K 375 L•	37,50	952,50	100
K 124 XL•	12,40	314,96	62	K 390 L	39,00	990,60	104
K 126 XL•	12,60	320,04	63	K 420 L	42,00	1066,80	112
K 128 XL•	12,80	325,12	64	K 427 L•	42,75	1085,85	114
K 130 XL	13,00	330,20	65	K 450 L	45,00	1143,00	120
K 136 XL•	13,60	345,44	68	K 480 L	48,00	1219,20	128
K 140 XL	14,00	355,60	70	K 510 L	51,00	1295,40	136
K 150 XL	15,00	381,00	75	K 525 L•	52,50	1333,50	140
K 152 XL•	15,20	386,08	76	K 540 L	54,00	1371,60	144
K 154 XL•	15,40	391,16	77	K 600 L	60,00	1524,00	160
K 160 XL	16,00	406,40	80				
K 166 XL•	16,60	421,64	83				
K 168 XL	16,80	426,72	84				
K 170 XL	17,00	431,80	85				
K 180 XL	18,00	457,20	90				
K 186 XL•	18,60	472,44	93				
K 190 XL	19,00	482,60	95				
K 200 XL	20,00	508,00	100				
K 210 XL	21,00	533,40	105				
K 212 XL•	21,20	538,48	106				
K 220 XL	22,00	558,80	110				
K 230 XL	23,00	584,20	115				
K 240 XL	24,00	609,60	120				
K 250 XL	25,00	635,00	125				
K 254 XL•	25,40	645,16	127				
K 260 XL	26,00	660,40	130				
K 270 XL	27,00	685,80	135				
K 290 XL	29,00	736,60	145				
K 300 XL	30,00	762,00	150				
K 320 XL•	32,00	812,80	160				
K 330 XL	33,00	838,20	165				
K 360 XL•	36,00	914,40	180				
K 376 XL•	37,60	955,04	188				
K 384 XL•	38,40	975,36	192				
K 390 XL	39,00	990,60	195				
K 414 XL•	41,40	1051,56	207				
K 460 XL•	46,00	1168,40	230				
K 480 XL•	48,00	1219,20	240				
K 512 XL•	51,20	1300,48	256				
K 550 XL•	55,00	1397,00	275				
K 564 XL•	56,40	1432,56	282				
K 630 XL•	63,00	1600,20	315				
K 670 XL•	67,00	1701,80	335				

Breite *Standard widths*:
1/4" – Code **025**; 5/16" – Code **031**; 3/8" – Code **037**; 1/2" – Code **050**.

Breite *Standard widths*:
1/2" – Code **050**; 3/4" – Code **075**; 1" – Code **100**; 1 1/2" – Code **150**.

Weitere Abmessungen auf Anfrage. *Further sizes on request.* • Keine Lagerware, Mindestabnahme: 2 Wickel. • *Non stock items, minimum order quantity: 2 sleeves.*

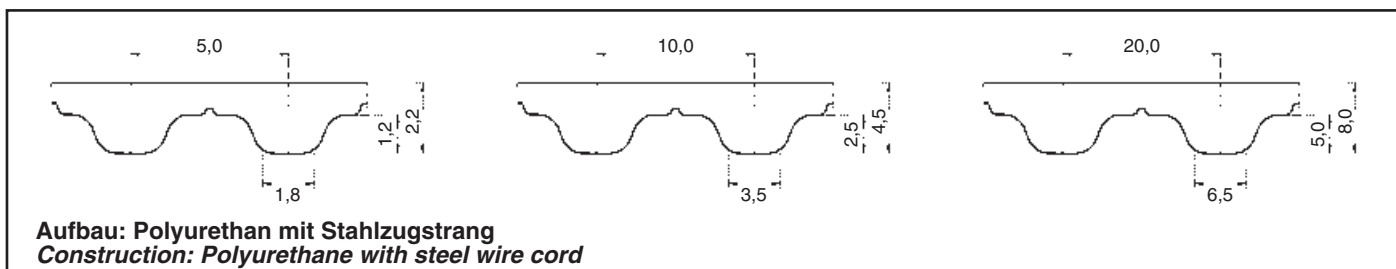

Type T5 – Teilung <i>pitch</i> 5 mm			Type T10 – Teilung <i>pitch</i> 10 mm			Type T20 – Teilung <i>pitch</i> 20 mm		
Artikel- Bezeichnung <i>Designation</i>	Wirklänge <i>Pitch length</i> (mm)	Anzahl der Zähne <i>Number of teeth</i>	Artikel- Bezeichnung <i>Designation</i>	Wirklänge <i>Pitch length</i> (mm)	Anzahl der Zähne <i>Number of teeth</i>	Artikel- Bezeichnung <i>Designation</i>	Wirklänge <i>Pitch length</i> (mm)	Anzahl der Zähne <i>Number of teeth</i>
T5/1500•	1500,00	300	T10/1500•	1500,00	150	T20/1500•	1500,00	75
T5/1600•	1600,00	320	T10/1600•	1600,00	160	T20/1600•	1600,00	80
T5/1700•	1700,00	340	T10/1700•	1700,00	170	T20/1700•	1700,00	85
T5/1800•	1800,00	360	T10/1800•	1800,00	180	T20/1800•	1800,00	90
T5/1900•	1900,00	380	T10/1900•	1900,00	190	T20/1900•	1900,00	95
T5/2000•	2000,00	400	T10/2000•	2000,00	200	T20/2000•	2000,00	100
T5/2100•	2100,00	420	T10/2100•	2100,00	210	T20/2100•	2100,00	105
T5/2200•	2200,00	440	T10/2200•	2200,00	220	T20/2200•	2200,00	110
T5/2300•	2300,00	460	T10/2300•	2300,00	230	T20/2300•	2300,00	115
T5/2400•	2400,00	480	T10/2400•	2400,00	240	T20/2400•	2400,00	120
T5/2500•	2500,00	500	T10/2500•	2500,00	250	T20/2500•	2500,00	125
T5/2600•	2600,00	520	T10/2600•	2600,00	260	T20/2600•	2600,00	130
T5/2700•	2700,00	540	T10/2700•	2700,00	270	T20/2700•	2700,00	135
T5/2800•	2800,00	560	T10/2800•	2800,00	280	T20/2800•	2800,00	140
T5/2900•	2900,00	580	T10/2900•	2900,00	290	T20/2900•	2900,00	145
T5/3000•	3000,00	600	T10/3000•	3000,00	300	T20/3000•	3000,00	150
T5/3200•	3200,00	640	T10/3200•	3200,00	320	T20/3200•	3200,00	160
T5/3400•	3400,00	680	T10/3400•	3400,00	340	T20/3400•	3400,00	170
T5/3600•	3600,00	720	T10/3600•	3600,00	360	T20/3600•	3600,00	180
T5/3800•	3800,00	760	T10/3800•	3800,00	380	T20/3800•	3800,00	190
T5/4000•	4000,00	800	T10/4000•	4000,00	400	T20/4000•	4000,00	200
T5/4200•	4200,00	840	T10/4200•	4200,00	420	T20/4200•	4200,00	210
T5/4400•	4400,00	880	T10/4400•	4400,00	440	T20/4400•	4400,00	220
T5/4600•	4600,00	920	T10/4600•	4600,00	460	T20/4600•	4600,00	230
T5/4800•	4800,00	960	T10/4800•	4800,00	480	T20/4800•	4800,00	240
T5/5000•	5000,00	1000	T10/5000•	5000,00	500	T20/5000•	5000,00	250
T5/5200•	5200,00	1040	T10/5200•	5200,00	520	T20/5200•	5200,00	260
T5/5400•	5400,00	1080	T10/5400•	5400,00	540	T20/5400•	5400,00	270
T5/5600•	5600,00	1120	T10/5600•	5600,00	560	T20/5600•	5600,00	280
T5/5800•	5800,00	1160	T10/5800•	5800,00	580	T20/5800•	5800,00	290
T5/6000•	6000,00	1200	T10/6000•	6000,00	600	T20/6000•	6000,00	300
T5/6200•	6200,00	1240	T10/6200•	6200,00	620	T20/6200•	6200,00	310
T5/6400•	6400,00	1280	T10/6400•	6400,00	640	T20/6400•	6400,00	320
T5/6600•	6600,00	1320	T10/6600•	6600,00	660	T20/6600•	6600,00	330
T5/6800•	6800,00	1360	T10/6800•	6800,00	680	T20/6800•	6800,00	340
T5/7000•	7000,00	1400	T10/7000•	7000,00	700	T20/7000•	7000,00	350

<p>Optibelt ALPHAflex Zahnriemen sind auch mit PAZ-Gewebebeschichtung lieferbar.</p> <p>Aufpreis: PAZ-Gewebe auf der Zahnseite</p> <p>Längen: 1500 mm - 24 000 mm</p> <p>Mindestabnahme: produktionsbedingt (100 mm oder 150 mm)</p> <p>Längen über 7000 mm auf Anfrage.</p> <p>• Keine Lagerware.</p> <p>Doppelzahnriemen Profil DT5/DT10 – auf Anfrage.</p>	<p><i>Optibelt ALPHAflex timing belts are available with PAZ-fabric.</i></p> <p><i>Surcharge: PAZ-fabric on tooth surface</i></p> <p><i>Length: 1500 mm - 24 000 mm</i></p> <p><i>Minimum quantity: according to production capability (100 mm or 150 mm)</i></p> <p><i>Lengths over 7000 mm on request.</i></p> <p>• Non stock items.</p> <p>Double toothed timing belts section DT5/DT10 – on request.</p>
--	---

Breite *Standard widths*:
 16 mm – Code 16; 25 mm – Code 25; 32 mm – Code 32; 50 mm – Code 50; 75 mm – Code 75; 100 mm – Code 100.

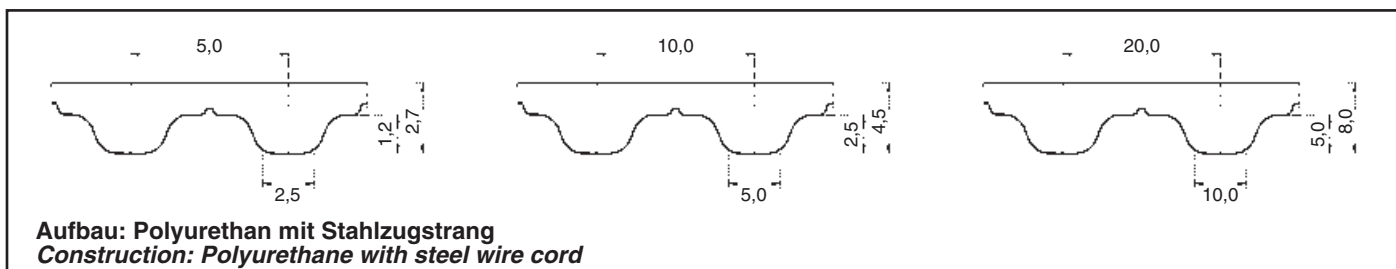

Type AT5 – Teilung <i>pitch</i> 5 mm			Type AT10 – Teilung <i>pitch</i> 10 mm			Type AT20 – Teilung <i>pitch</i> 20 mm		
Artikel- Bezeichnung Designation	Wirklänge Pitch length (mm)	Anzahl der Zähne Number of teeth	Artikel- Bezeichnung Designation	Wirklänge Pitch length (mm)	Anzahl der Zähne Number of teeth	Artikel- Bezeichnung Designation	Wirklänge Pitch length (mm)	Anzahl der Zähne Number of teeth
AT5/1500•	1500,00	300	AT10/1500•	1500,00	150	AT20/1500•	1500,00	75
AT5/1600•	1600,00	320	AT10/1600•	1600,00	160	AT20/1600•	1600,00	80
AT5/1700•	1700,00	340	AT10/1700•	1700,00	170	AT20/1700•	1700,00	85
AT5/1800•	1800,00	360	AT10/1800•	1800,00	180	AT20/1800•	1800,00	90
AT5/1900•	1900,00	380	AT10/1900•	1900,00	190	AT20/1900•	1900,00	95
AT5/2000•	2000,00	400	AT10/2000•	2000,00	200	AT20/2000•	2000,00	100
AT5/2100•	2100,00	420	AT10/2100•	2100,00	210	AT20/2100•	2100,00	105
AT5/2200•	2200,00	440	AT10/2200•	2200,00	220	AT20/2200•	2200,00	110
AT5/2300•	2300,00	460	AT10/2300•	2300,00	230	AT20/2300•	2300,00	115
AT5/2400•	2400,00	480	AT10/2400•	2400,00	240	AT20/2400•	2400,00	120
AT5/2500•	2500,00	500	AT10/2500•	2500,00	250	AT20/2500•	2500,00	125
AT5/2600•	2600,00	520	AT10/2600•	2600,00	260	AT20/2600•	2600,00	130
AT5/2700•	2700,00	540	AT10/2700•	2700,00	270	AT20/2700•	2700,00	135
AT5/2800•	2800,00	560	AT10/2800•	2800,00	280	AT20/2800•	2800,00	140
AT5/2900•	2900,00	580	AT10/2900•	2900,00	290	AT20/2900•	2900,00	145
AT5/3000•	3000,00	600	AT10/3000•	3000,00	300	AT20/3000•	3000,00	150
AT5/3200•	3200,00	640	AT10/3200•	3200,00	320	AT20/3200•	3200,00	160
AT5/3400•	3400,00	680	AT10/3400•	3400,00	340	AT20/3400•	3400,00	170
AT5/3600•	3600,00	720	AT10/3600•	3600,00	360	AT20/3600•	3600,00	180
AT5/3800•	3800,00	760	AT10/3800•	3800,00	380	AT20/3800•	3800,00	190
AT5/4000•	4000,00	800	AT10/4000•	4000,00	400	AT20/4000•	4000,00	200
AT5/4200•	4200,00	840	AT10/4200•	4200,00	420	AT20/4200•	4200,00	210
AT5/4400•	4400,00	880	AT10/4400•	4400,00	440	AT20/4400•	4400,00	220
AT5/4600•	4600,00	920	AT10/4600•	4600,00	460	AT20/4600•	4600,00	230
AT5/4800•	4800,00	960	AT10/4800•	4800,00	480	AT20/4800•	4800,00	240
AT5/5000•	5000,00	1000	AT10/5000•	5000,00	500	AT20/5000•	5000,00	250
AT5/5200•	5200,00	1040	AT10/5200•	5200,00	520	AT20/5200•	5200,00	260
AT5/5400•	5400,00	1080	AT10/5400•	5400,00	540	AT20/5400•	5400,00	270
AT5/5600•	5600,00	1120	AT10/5600•	5600,00	560	AT20/5600•	5600,00	280
AT5/5800•	5800,00	1160	AT10/5800•	5800,00	580	AT20/5800•	5800,00	290
AT5/6000•	6000,00	1200	AT10/6000•	6000,00	600	AT20/6000•	6000,00	300
AT5/6200•	6200,00	1240	AT10/6200•	6200,00	620	AT20/6200•	6200,00	310
AT5/6400•	6400,00	1280	AT10/6400•	6400,00	640	AT20/6400•	6400,00	320
AT5/6600•	6600,00	1320	AT10/6600•	6600,00	660	AT20/6600•	6600,00	330
AT5/6800•	6800,00	1360	AT10/6800•	6800,00	680	AT20/6800•	6800,00	340
AT5/7000•	7000,00	1400	AT10/7000•	7000,00	700	AT20/7000•	7000,00	350

<p>Optibelt ALPHAflex Zahnriemen sind auch mit PAZ-Gewebebeschichtung lieferbar.</p> <p>Aufpreis: PAZ-Gewebe auf der Zahnseite</p> <p>Längen: 1500 mm - 24 000 mm</p> <p>Mindestabnahme: produktionsbedingt (100 mm oder 150 mm)</p> <p>Längen über 7000 mm auf Anfrage.</p> <p>• Keine Lagerware.</p> <p>Doppelzahnriemen Profil DAT5/DAT10 – auf Anfrage.</p>	<p><i>Optibelt ALPHAflex timing belts are available with PAZ-fabric.</i></p> <p><i>Surcharge: PAZ-fabric on tooth surface</i></p> <p><i>Length: 1500 mm - 24 000 mm</i></p> <p><i>Minimum quantity: according to production capability (100 mm or 150 mm)</i></p> <p><i>Lengths over 7000 mm on request.</i></p> <p>• Non stock items.</p> <p>Double toothed timing belts section DAT5/DAT10 – on request.</p>
--	---

Breite *Standard widths*:
 16 mm – Code 16; 25 mm – Code 25; 32 mm – Code 32; 50 mm – Code 50; 75 mm – Code 75; 100 mm – Code 100.

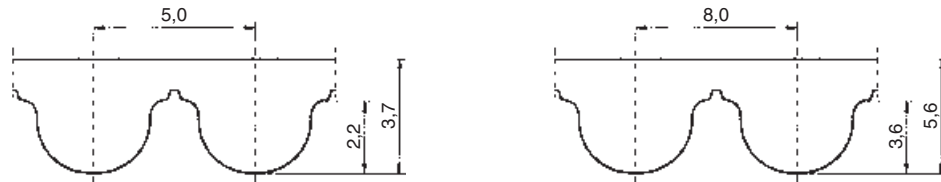

Aufbau: Polyurethan mit Stahlzugstrang
Construction: Polyurethane with steel wire cord

Type 5M – Teilung <i>pitch</i> 5 mm			Type 8M – Teilung <i>pitch</i> 8 mm		
Artikel- Bezeichnung <i>Designation</i>	Wirklänge <i>Pitch length</i> (mm)	Anzahl der Zähne <i>Number</i> of teeth	Artikel- Bezeichnung <i>Designation</i>	Wirklänge <i>Pitch length</i> (mm)	Anzahl der Zähne <i>Number</i> of teeth
5M/1500•	1500,00	300	8M/1504•	1504,00	188
5M/1600•	1600,00	320	8M/1600•	1600,00	200
5M/1700•	1700,00	340	8M/1704•	1704,00	213
5M/1800•	1800,00	360	8M/1800•	1800,00	225
5M/1900•	1900,00	380	8M/1904•	1904,00	238
5M/2000•	2000,00	400	8M/2000•	2000,00	250
5M/2100•	2100,00	420	8M/2104•	2104,00	263
5M/2200•	2200,00	440	8M/2200•	2200,00	275
5M/2300•	2300,00	460	8M/2304•	2304,00	288
5M/2400•	2400,00	480	8M/2400•	2400,00	300
5M/2500•	2500,00	500	8M/2504•	2504,00	313
5M/2600•	2600,00	520	8M/2600•	2600,00	325
5M/2700•	2700,00	540	8M/2704•	2704,00	338
5M/2800•	2800,00	560	8M/2800•	2800,00	350
5M/2900•	2900,00	580	8M/2904•	2904,00	363
5M/3000•	3000,00	600	8M/3000•	3000,00	375
5M/3200•	3200,00	640	8M/3200•	3200,00	400
5M/3400•	3400,00	680	8M/3400•	3400,00	425
5M/3600•	3600,00	720	8M/3600•	3600,00	450
5M/3800•	3800,00	760	8M/3800•	3800,00	475
5M/4000•	4000,00	800	8M/4000•	4000,00	500
5M/4200•	4200,00	840	8M/4200•	4200,00	525
5M/4400•	4400,00	880	8M/4400•	4400,00	550
5M/4600•	4600,00	920	8M/4600•	4600,00	575
5M/4800•	4800,00	960	8M/4800•	4800,00	600
5M/5000•	5000,00	1000	8M/5000•	5000,00	625
5M/5200•	5200,00	1040	8M/5200•	5200,00	650
5M/5400•	5400,00	1080	8M/5400•	5400,00	675
5M/5600•	5600,00	1120	8M/5600•	5600,00	700
5M/5800•	5800,00	1160	8M/5800•	5800,00	725
5M/6000•	6000,00	1200	8M/6000•	6000,00	750
5M/6200•	6200,00	1240	8M/6200•	6200,00	775
5M/6400•	6400,00	1280	8M/6400•	6400,00	800
5M/6600•	6600,00	1320	8M/6600•	6600,00	825
5M/6800•	6800,00	1360	8M/6800•	6800,00	850
5M/7000•	7000,00	1400	8M/7000•	7000,00	875

<p>Optibelt ALPHAflex Zahnriemen sind auch mit PAZ-Gewebebeschichtung lieferbar.</p> <p>Aufpreis: PAZ-Gewebe auf der Zahnseite</p> <p>Längen: 1500 mm - 24 000 mm</p> <p>Mindest- abnahme: produktionsbedingt (100 mm oder 150 mm)</p> <p>Längen über 7000 mm auf Anfrage.</p> <p>• Keine Lagerware.</p> <p>Doppelzahnriemen Profil D5M – auf Anfrage.</p>	<p><i>Optibelt ALPHAflex timing belts are available with PAZ-fabric.</i></p> <p><i>Surcharge:</i> PAZ-fabric on tooth surface</p> <p><i>Length:</i> 1500 mm - 24 000 mm</p> <p><i>Minimum quantity:</i> according to production capability (100 mm or 150 mm)</p> <p><i>Lengths over 7000 mm on request.</i></p> <p>• Non stock items.</p> <p>Double toothed timing belts section D5M – on request.</p>
--	--

Breite *Standard widths:*
 15 mm – Code 15; 25 mm – Code 25; 50 mm – Code 50;
 75 mm – Code 75; 100 mm – Code 100.

Breite *Standard widths:*
 20 mm – Code 20; 25 mm – Code 25; 30 mm – Code 30;
 50 mm – Code 50; 85 mm – Code 85; 100 mm – Code 100.

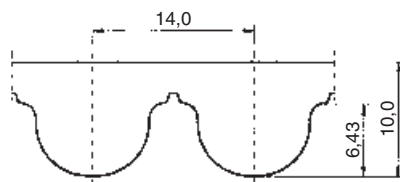

Aufbau: Polyurethan mit Stahlzugstrang
Construction: Polyurethane with steel wire cord

Type 14M – Teilung *pitch* 14 mm

Artikel- Bezeichnung <i>Designation</i>	Wirklänge <i>Pitch length</i> (mm)	Anzahl der Zähne <i>Number</i> of teeth	Artikel- Bezeichnung <i>Designation</i>	Wirklänge <i>Pitch length</i> (mm)	Anzahl der Zähne <i>Number</i> of teeth
14M/1512•	1512,00	108	14M/4550•	4550,00	325
14M/1596•	1596,00	114	14M/4606•	4606,00	329
14M/1694•	1694,00	121	14M/4704•	4704,00	336
14M/1750•	1750,00	125	14M/4802•	4802,00	343
14M/1806•	1806,00	129	14M/4900•	4900,00	350
14M/1904•	1904,00	136	14M/4998•	4998,00	357
14M/2002•	2002,00	143	14M/5096•	5096,00	364
14M/2100•	2100,00	150	14M/5194•	5194,00	371
14M/2198•	2198,00	157	14M/5250•	5250,00	375
14M/2296•	2296,00	164	14M/5306•	5306,00	379
14M/2394•	2394,00	171	14M/5404•	5404,00	386
14M/2450•	2450,00	175	14M/5502•	5502,00	393
14M/2506•	2506,00	179	14M/5600•	5600,00	400
14M/2604•	2604,00	186	14M/5698•	5698,00	407
14M/2702•	2702,00	193	14M/5796•	5796,00	414
14M/2800•	2800,00	200	14M/5894•	5894,00	421
14M/2898•	2898,00	207	14M/5950•	5950,00	425
14M/2996•	2996,00	214	14M/6006•	6006,00	429
14M/3094•	3094,00	221	14M/6104•	6104,00	436
14M/3150•	3150,00	225	14M/6202•	6202,00	443
14M/3206•	3206,00	229	14M/6300•	6300,00	450
14M/3304•	3304,00	236	14M/6398•	6398,00	457
14M/3402•	3402,00	243	14M/6496•	6496,00	464
14M/3500•	3500,00	250	14M/6594•	6594,00	471
14M/3598•	3598,00	257	14M/6650•	6650,00	475
14M/3696•	3696,00	264	14M/6706•	6706,00	479
14M/3794•	3794,00	271	14M/6804•	6804,00	486
14M/3850•	3850,00	275	14M/6902•	6902,00	493
14M/3906•	3906,00	279	14M/7000•	7000,00	500
14M/4004•	4004,00	286			
14M/4102•	4102,00	293			
14M/4200•	4200,00	300			
14M/4298•	4298,00	307			
14M/4396•	4396,00	314			
14M/4494•	4494,00	321			

Optibelt ALPHAflex Zahnriemen sind auch mit PAZ-Gewebebeschichtung lieferbar.

Aufpreis: PAZ-Gewebe auf der Zahnseite

Längen: 1512 mm - 24000 mm

Mindest- produktionsbedingt
 abnahme: (100 mm oder 150 mm)

Längen über 7000 mm auf Anfrage.

• Keine Lagerware.

Optibelt ALPHAflex timing belts are available with PAZ-fabric.

Surcharge: PAZ-fabric on tooth surface

Length: 1512 mm - 24000 mm

Minimum according to production capability
 quantity: (100 mm or 150 mm)

Lengths over 7000 mm on request.

• Non stock items.

Breite *Standard widths*:

25 mm – Code **25**; 40 mm – Code **40**; 55 mm – Code **55**;
 85 mm – Code **85**; 100 mm – Code **100**.

<p>XL / L / H / XH 8M / 14M</p> <p>Aufbau: Polyurethan mit Aramid- oder Stahlzugstrang Construction: Polyurethane with Aramid or steel wire cord</p>	Type	XL	L	H	XH	5M	8M	14M	
	Teilung Pitch	t	5,08	9,525	12,7	22,225	5,00	8,00	14,00
	Zahnw. Tooth angle	β	50°	40°	40°	40°	—	—	—
	Zahnhöhe Height of tooth	h_t	1,27	1,91	2,29	6,35	2,08	3,38	6,00
	Zahnbreite Width of tooth	s	2,57	4,65	6,12	12,57	—	—	—
	Ges.-Riemenhöhe Total belt thickness	h_s	2,30	3,60	4,30	11,20	3,70	5,60	10,00

Aramidzugstrang Aramid cord			Stahlzugstrang Steel cord		
Artikel-Bezeichnung Belt no.	Teilung Pitch (mm)	Riemenbreite Belt width (mm)	Artikel-Bezeichnung Belt no.	Teilung Pitch (mm)	Riemenbreite Belt width (mm)
XL 025	5,080	6,35	XL 025•	5,080	6,35
XL 031	5,080	7,94	XL 031•	5,080	7,94
XL 037	5,080	9,53	XL 037•	5,080	9,53
XL 050	5,080	12,70	XL 050•	5,080	12,70
XL 075	5,080	19,05	XL 075•	5,080	19,05
XL 100•	5,080	25,40	XL 100•	5,080	25,40
L 037	9,525	9,53	L 037	9,525	9,53
L 050	9,525	12,70	L 050	9,525	12,70
L 075	9,525	19,05	L 075	9,525	19,05
L 100	9,525	25,40	L 100	9,525	25,40
L 150	9,525	38,10	L 150	9,525	38,10
L 200	9,525	50,80	L 200	9,525	50,80
H 050	12,700	12,70	L 300	9,525	76,20
H 075	12,700	19,05	L 400	9,525	101,60
H 100	12,700	25,40	H 050	12,700	12,70
H 150	12,700	38,10	H 075	12,700	19,05
H 200	12,700	50,80	H 100	12,700	25,40
H 300	12,700	76,20	H 150	12,700	38,10
H 400•	12,700	101,60	H 200	12,700	50,80
XH 100•	22,225	25,40	H 300	12,700	76,20
XH 200•	22,225	50,80	H 400•	12,700	101,60
XH 300•	22,225	76,20	XH 100▲	22,225	25,40
XH 400•	22,225	101,60	XH 200▲	22,225	50,80
8M 20•	8,000	20,00	XH 300▲	22,225	76,20
8M 25•	8,000	25,00	XH 400▲	22,225	101,60
8M 30•	8,000	30,00	5M 10	5,000	10,00
8M 50•	8,000	50,00	5M 15	5,000	15,00
8M 85•	8,000	85,00	5M 25	5,000	25,00
14M 25•	14,000	25,00	5M 50	5,000	50,00
14M 40•	14,000	40,00	8M 20	8,000	20,00
14M 55•	14,000	55,00	8M 25	8,000	25,00
14M 85•	14,000	85,00	8M 30	8,000	30,00
			8M 50	8,000	50,00
			8M 85	8,000	85,00
			8M 100	8,000	100,00
			14M 25	14,000	25,00
			14M 40	14,000	40,00
			14M 55	14,000	55,00
			14M 85	14,000	85,00
			14M 100	14,000	100,00
			14M 150	14,000	150,00

<p>Mindestlänge für verschweißte Zahnflachriemen: <i>Minimum lengths for spliced timing belts:</i></p> <p>Aramidzugstrang <i>Aramid cord</i> Stahlzugstrang <i>Steel wire cord</i></p> <p>XL / L / H = 500 mm L / H / XH = 1000 mm 5M / 8M / 14M = 1000 mm</p> <ul style="list-style-type: none"> Keine Lagerware. Non stock items. 	<p>Weitere Ausführungen auf Anfrage. <i>Further constructions on request.</i></p> <p>▲ mit PAZ-Gewebe <i>with PAZ-fabric on tooth surface</i></p> <p>Weitere Breiten auf Anfrage. <i>Further widths on request.</i></p> <p>Rollenlänge <i>Length of roll:</i> 50 m</p> <p>Mindestmenge für verschweißte Zahnflachriemen < 16 mm Breite: 2 Stück je Abmessung <i>Minimum quantities for spliced timing belts</i> < 16 mm width: 2 pieces per size</p>
--	--

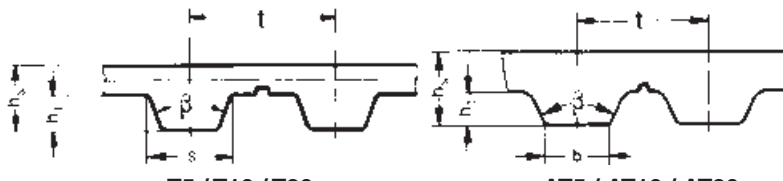

Type	T5	T10	T20	AT5	AT10	AT20	
Teilung Pitch	t	5,0	10,0	20,0	5,0	10,0	20,0
Zahnw. Tooth angle	β	40°	40°	40°	50°	50°	50°
Zahnhöhe Height of tooth	h_t	1,20	2,50	5,00	1,20	2,50	5,00
Zahnbreite Width of tooth	s/b	2,65	5,30	10,15	2,50	5,00	10,00
Ges.-Riemenhöhe Total belt thickness	h_s	2,20	4,50	8,00	2,70	4,50	8,00

Aufbau: Polyurethan mit Aramid- oder Stahlzugstrang
Construction: Polyurethane with Aramid or steel wire cord

Aramidzugstrang <i>Aramid cord</i>			Stahlzugstrang <i>Steel cord</i>		
Artikel- Bezeichnung Belt no.	Teilung Pitch (mm)	Riemenbreite Belt width (mm)	Artikel- Bezeichnung Belt no.	Teilung Pitch (mm)	Riemenbreite Belt width (mm)
6 T5	5,0	6,0	6 T5	5,0	6,0
8 T5	5,0	8,0	8 T5	5,0	8,0
10 T5	5,0	10,0	10 T5	5,0	10,0
12 T5	5,0	12,0	12 T5	5,0	12,0
16 T5	5,0	16,0	16 T5	5,0	16,0
20 T5	5,0	20,0	20 T5	5,0	20,0
25 T5	5,0	25,0	25 T5	5,0	25,0
32 T5	5,0	32,0	32 T5	5,0	32,0
50 T5*	5,0	50,0	50 T5	5,0	50,0
10 T10	10,0	10,0	75 T5	5,0	75,0
12 T10	10,0	12,0	100 T5	5,0	100,0
16 T10	10,0	16,0	10 T10	10,0	10,0
20 T10	10,0	20,0	12 T10	10,0	12,0
25 T10	10,0	25,0	16 T10	10,0	16,0
32 T10	10,0	32,0	20 T10	10,0	20,0
40 T10	10,0	40,0	25 T10	10,0	25,0
50 T10	10,0	50,0	32 T10	10,0	32,0
75 T10	10,0	75,0	40 T10	10,0	40,0
100 T10	10,0	100,0	50 T10	10,0	50,0
25 T20	20,0	25,0	75 T10	10,0	75,0
32 T20	20,0	32,0	100 T10	10,0	100,0
50 T20	20,0	50,0	150 T10	10,0	150,0
75 T20	20,0	75,0	25 T20	20,0	25,0
100 T20	20,0	100,0	32 T20	20,0	32,0
6 AT5*	5,0	6,0	50 T20	20,0	50,0
10 AT5*	5,0	10,0	75 T20	20,0	75,0
16 AT5*	5,0	16,0	100 T20	20,0	100,0
25 AT5*	5,0	25,0	150 T20	20,0	150,0
32 AT5*	5,0	32,0	6 AT5	5,0	6,0
50 AT5*	5,0	50,0	10 AT5	5,0	10,0
16 AT10*	10,0	16,0	16 AT5	5,0	16,0
25 AT10*	10,0	25,0	25 AT5	5,0	25,0
32 AT10*	10,0	32,0	32 AT5	5,0	32,0
50 AT10*	10,0	50,0	50 AT5	5,0	50,0
75 AT10*	10,0	75,0	75 AT5	5,0	75,0
100 AT10*	10,0	100,0	100 AT5	5,0	100,0
25 AT20*	20,0	25,0	16 AT10	10,0	16,0
32 AT20*	20,0	32,0	25 AT10	10,0	25,0
50 AT20*	20,0	50,0	32 AT10	10,0	32,0
75 AT20*	20,0	75,0	50 AT10	10,0	50,0
100 AT20*	20,0	100,0	75 AT10	10,0	75,0
			100 AT10	10,0	100,0
			150 AT10	10,0	150,0
			25 AT20	20,0	25,0
			32 AT20	20,0	32,0
			50 AT20	20,0	50,0
			75 AT20	20,0	75,0
			100 AT20	20,0	100,0
			150 AT20	20,0	150,0

Mindestlänge für verschweißte Zahnflachriemen: <i>Minimum lengths for spliced timing belts:</i> Aramidzugstrang <i>Aramid cord</i> Stahlzugstrang <i>Steel wire cord</i> T5 / T10 = 500 mm T5/T10 = 600 mm T20 = 900 mm T20 = 1000 mm AT5 = 1000 mm AT10 = 1000 mm AT20 = 1000 mm • Keine Lagerware. • <i>Non stock items.</i>	Weitere Ausführungen auf Anfrage. <i>Further constructions on request.</i> Weitere Breiten auf Anfrage. <i>Further widths on request.</i> Rollenlänge <i>Length of roll:</i> 50 m Mindestmenge für verschweißte Zahnflachriemen < 16 mm Breite: 2 Stück je Abmessung <i>Minimum quantities for spliced timing belts</i> < 16 mm width: 2 pieces per size
---	---

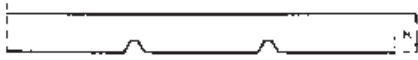

Type	F 2	F 3	
Höhe Height (mm)	h	2	3

Aufbau: Polyurethan (92 Shore A) mit Stahlzugstrang
Construction: Polyurethane (92 Shore A) with steel wire cord

Stahlzugstrang *Steel cord*

Artikel- Bezeichnung <i>Designation</i>	Riemenbreite <i>Belt width</i> (mm)	Rollenlänge <i>Roll length</i> (m)
25 F2 - St	25,0	50
30 F2 - St	30,0	50
50 F2 - St	50,0	50
75 F2 - St	75,0	50
100 F2 - St	100,0	50
25 F3 - St	25,0	50
30 F3 - St	30,0	50
50 F3 - St	50,0	50
75 F3 - St	75,0	50
100 F3 - St	100,0	50
Anfertigungsware <i>Non stock items</i>		

Weitere Breiten auf Anfrage.
Further widths on request.

Optibelt ALPHA linear – F Flachriemen sind nutseitig auch mit PA-Gewebe lieferbar.
Optibelt ALPHA linear – F flat belts are available with PA-fabric, at groove face.

optibelt ALPHA SRP Spezialriemen aus Polyurethan
Timing Belts for Special Applications

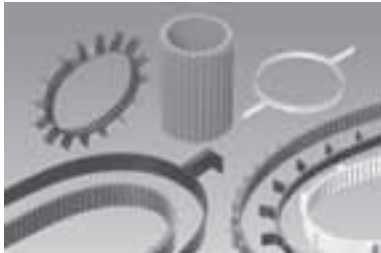
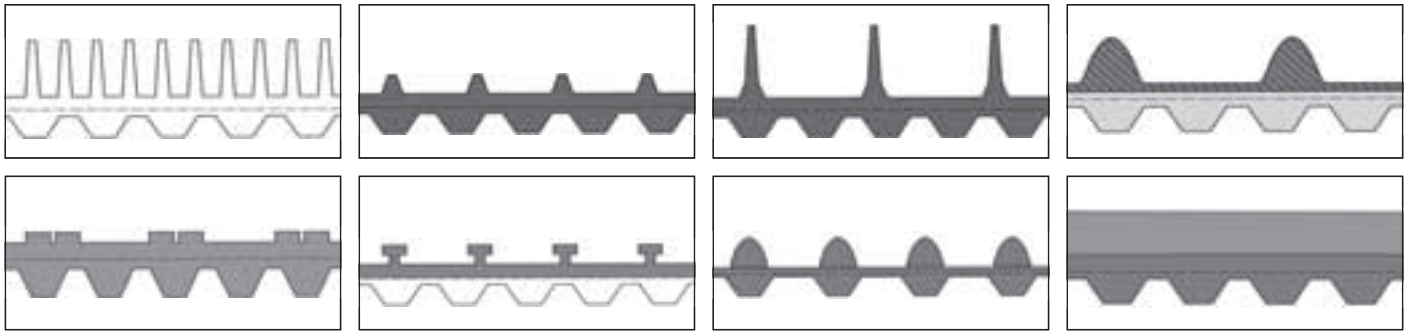

ALPHA SRP

gegossen – endlos

AT5 – AT10 – AT20
T2,5 – T5 – T10 – T20
MXL – XL – L

Optibelt ALPHA SRP sind endlose Zahnflachriemen, die in einem besonderen Verfahren direkt in der Gießform hergestellt werden. Dadurch ist es möglich, mehrlagige Riemen aufzubauen mit unterschiedlichen Profilen und Eigenschaften (Härte, Farbe und Reibwert) in einem Arbeitsgang anzufertigen.

ALPHA SRP

cast – endless

AT5 – AT10 – AT20
T2,5 – T5 – T10 – T20
MXL – XL – L

Optibelt ALPHA SRP are endless timing belts which are produced directly in the mould using a special process. This makes it possible to produce multi-layered belt structures with different sections and properties (hardness, colour and frictional value) in a single process.

optibelt ALPHA Spezial Spezialriemen aus Polyurethan
Timing Belts for Special Applications

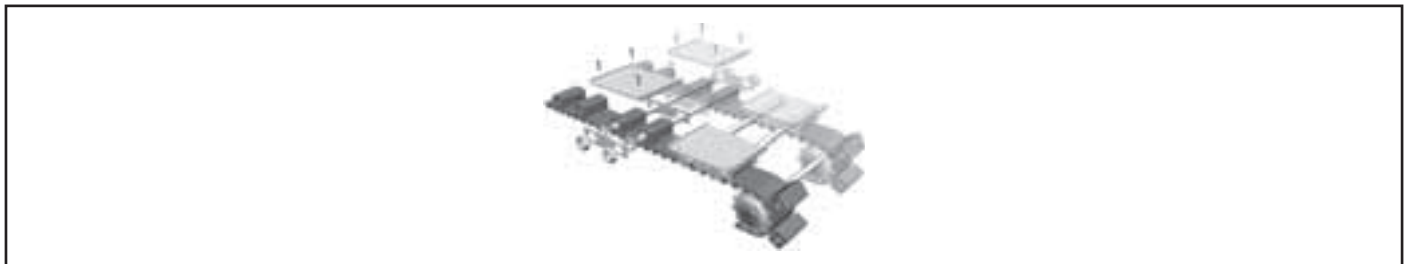

ALPHA Spezial

endlos

- Rückenbeschichtungen
- Nocken auf Riemenrücken
- Riemen mit mech. Bearbeitung

Optibelt ALPHA Spezial werden überall dort eingesetzt, wo etwas transportiert, positioniert oder zugeführt werden muss. Ganz gleich, in welcher Ausführung, ob beschichtet, gelocht, geschliffen oder mit Nocken versehen – sie bieten stets ausreichend Spielraum für innovative Antriebslösungen.

ALPHA Spezial

endless

- Surface coatings
- Cleats on the belt back
- Belt with mech. processing

Optibelt ALPHA Spezial timing belts are used wherever materials need to be conveyed, positioned or fed. Whatever the version, whether coated, perforated, polished or equipped with cleats – these belts always offer possibilities for innovative drive solutions.

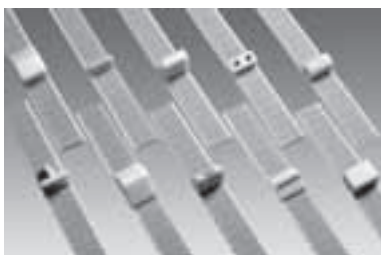

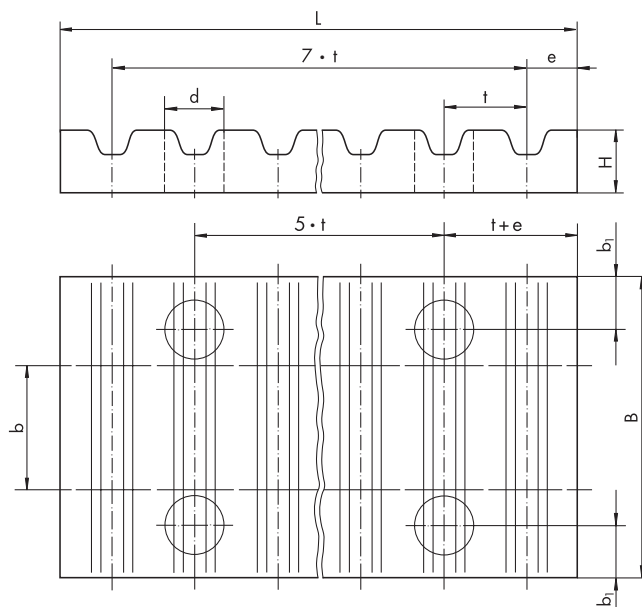

Artikel-Bezeichnung Designation	Teilung Pitch t (mm)	Riemenbreite Belt width b (mm)	Material	B (mm)	b_1 (mm)	L (mm)	e (mm)	H (mm)	d (mm)	Gewicht Weight ≈ (kg)
CP-XL 025	5,080	6,35	Al	25,5	6,0	42,5	3,5	8,0	5,5	0,020
CP-XL 037	5,080	9,53	Al	28,5	6,0	42,5	3,5	8,0	5,5	0,025
CP-XL 050	5,080	12,70	Al	32,0	6,0	42,5	3,5	8,0	5,5	0,027
CP-XL 075	5,080	19,05	Al	38,0	6,0	42,5	3,5	8,0	5,5	0,032
CP-XL 100•	5,080	25,40	Al	45,0	6,0	42,5	3,5	8,0	5,5	0,038
CP-L 037	9,525	9,53	Al	36,0	8,0	76,6	5,0	15,0	9,0	0,095
CP-L 050	9,525	12,70	Al	39,0	8,0	76,6	5,0	15,0	9,0	0,104
CP-L 075	9,525	19,05	Al	45,0	8,0	76,6	5,0	15,0	9,0	0,121
CP-L 100	9,525	25,40	Al	51,5	8,0	76,6	5,0	15,0	9,0	0,140
CP-L 150	9,525	38,10	Al	64,0	8,0	76,6	5,0	15,0	9,0	0,177
CP-L 200	9,525	50,80	Al	77,0	8,0	76,6	5,0	15,0	9,0	0,215
CP-H 050	12,700	12,70	Al	45,0	10,0	106,9	9,0	22,0	11,0	0,050
CP-H 075	12,700	19,05	Al	51,0	10,0	106,9	9,0	22,0	11,0	0,075
CP-H 100	12,700	25,40	Al	57,5	10,0	106,9	9,0	22,0	11,0	0,100
CP-H 150	12,700	38,10	Al	70,0	10,0	106,9	9,0	22,0	11,0	0,150
CP-H 200	12,700	50,80	Al	83,0	10,0	106,9	9,0	22,0	11,0	0,200
CP-H 300	12,700	76,20	Al	108,0	10,0	106,9	9,0	22,0	11,0	0,300
CP-H 400•	12,700	101,60	Al	134,0	10,0	106,9	9,0	22,0	11,0	0,400
CP-5M 06	5,000	6,00	Al	25,0	6,0	41,8	3,2	8,0	5,5	0,015
CP-5M 09	5,000	9,00	Al	28,0	6,0	41,8	3,2	8,0	5,5	0,018
CP-5M 15	5,000	15,00	Al	34,0	6,0	41,8	3,2	8,0	5,5	0,022
CP-5M 25	5,000	25,00	Al	44,0	6,0	41,8	3,2	8,0	5,5	0,030
CP-8M 10	8,000	10,00	Al	35,0	8,0	66,0	5,0	15,0	9,0	0,075
CP-8M 15	8,000	15,00	Al	40,0	8,0	66,0	5,0	15,0	9,0	0,085
CP-8M 20	8,000	20,00	Al	45,0	8,0	66,0	5,0	15,0	9,0	0,100
CP-8M 30	8,000	30,00	Al	55,0	8,0	66,0	5,0	15,0	9,0	0,120
CP-8M 50	8,000	50,00	Al	75,0	8,0	66,0	5,0	15,0	9,0	0,170
CP-8M 85	8,000	85,00	Al	110,0	8,0	66,0	5,0	15,0	9,0	0,250
CP-14M 25	14,000	25,00	Al	56,0	10,0	116,0	9,0	22,0	11,0	0,315
CP-14M 40	14,000	40,00	Al	71,0	10,0	116,0	9,0	22,0	11,0	0,405
CP-14M 55	14,000	55,00	Al	86,0	10,0	116,0	9,0	22,0	11,0	0,495
CP-14M 85	14,000	85,00	Al	116,0	10,0	116,0	9,0	22,0	11,0	0,860
CP-14M 115•	14,000	115,00	Al	146,0	10,0	116,0	9,0	22,0	11,0	1,195

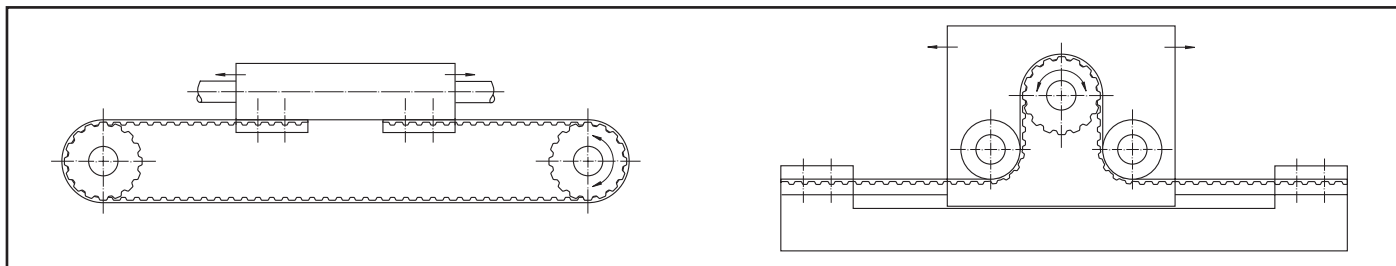

Artikel-Bezeichnung Designation	Teilung Pitch t (mm)	Riemenbreite Belt width b (mm)	Material	B (mm)	b ₁ (mm)	L (mm)	e (mm)	H (mm)	d (mm)	Gewicht Weight ≈ (kg)
CP- 6 T5	5,000	6,00	Al	25,0	6,0	41,8	3,2	8,0	5,5	0,020
CP- 10 T5	5,000	10,00	Al	29,0	6,0	41,8	3,2	8,0	5,5	0,025
CP- 16 T5	5,000	16,00	Al	35,0	6,0	41,8	3,2	8,0	5,5	0,030
CP- 25 T5	5,000	25,00	Al	44,0	6,0	41,8	3,2	8,0	5,5	0,036
CP- 32 T5	5,000	32,00	Al	51,0	6,0	41,8	3,2	8,0	5,5	0,042
CP- 50 T5•	5,000	50,00	Al	69,0	6,0	41,8	3,2	8,0	5,5	0,051
CP- 16 T10	10,000	16,00	Al	41,0	8,0	80,0	5,0	15,0	9,0	0,115
CP- 25 T10	10,000	25,00	Al	50,0	8,0	80,0	5,0	15,0	9,0	0,140
CP- 32 T10	10,000	32,00	Al	57,0	8,0	80,0	5,0	15,0	9,0	0,160
CP- 50 T10	10,000	50,00	Al	75,0	8,0	80,0	5,0	15,0	9,0	0,215
CP- 75 T10•	10,000	75,00	Al	100,0	8,0	80,0	5,0	15,0	9,0	0,290
CP-100 T10•	10,000	100,00	Al	125,0	8,0	80,0	5,0	15,0	9,0	0,370
CP- 25 T20	20,000	25,00	Al	56,0	10,0	160,0	10,0	20,0	11,0	0,385
CP- 32 T20	20,000	32,00	Al	65,0	10,0	160,0	10,0	20,0	11,0	0,450
CP- 50 T20	20,000	50,00	Al	81,0	10,0	160,0	10,0	20,0	11,0	0,570
CP- 75 T20	20,000	75,00	Al	106,0	10,0	160,0	10,0	20,0	11,0	0,755
CP-100 T20•	20,000	100,00	Al	132,0	10,0	160,0	10,0	20,0	11,0	0,940
CP- 6 AT5	5,000	6,00	Al	25,0	6,0	41,8	3,2	8,0	5,5	0,016
CP- 10 AT5	5,000	10,00	Al	29,0	6,0	41,8	3,2	8,0	5,5	0,019
CP- 16 AT5	5,000	16,00	Al	35,0	6,0	41,8	3,2	8,0	5,5	0,024
CP- 25 AT5	5,000	25,00	Al	44,0	6,0	41,8	3,2	8,0	5,5	0,031
CP- 32 AT5	5,000	32,00	Al	51,0	6,0	41,8	3,2	8,0	5,5	0,036
CP- 50 AT5•	5,000	50,00	Al	61,0	6,0	41,8	3,2	8,0	5,5	0,043
CP- 16 AT10	10,000	16,00	Al	41,0	8,0	80,0	5,0	15,0	9,0	0,110
CP- 25 AT10	10,000	25,00	Al	50,0	8,0	80,0	5,0	15,0	9,0	0,135
CP- 32 AT10	10,000	32,00	Al	57,0	8,0	80,0	5,0	15,0	9,0	0,155
CP- 50 AT10	10,000	50,00	Al	75,0	8,0	80,0	5,0	15,0	9,0	0,205
CP- 75 AT10	10,000	75,00	Al	100,0	8,0	80,0	5,0	15,0	9,0	0,280
CP-100 AT10•	10,000	100,00	Al	125,0	8,0	80,0	5,0	15,0	9,0	0,350
CP- 25 AT20	20,000	25,00	Al	56,0	10,0	160,0	10,0	20,0	11,0	0,385
CP- 32 AT20	20,000	32,00	Al	65,0	10,0	160,0	10,0	20,0	11,0	0,450
CP- 50 AT20	20,000	50,00	Al	81,0	10,0	160,0	10,0	20,0	11,0	0,570
CP- 75 AT20	20,000	75,00	Al	106,0	10,0	160,0	10,0	20,0	11,0	0,755
CP-100 AT20•	20,000	100,00	Al	132,0	10,0	160,0	10,0	20,0	11,0	0,940

Riemen für spezielle Anwendungen

Belts for Special Applications

optibelt



optibelt RB



optibelt DK



optibelt RR PLUS



optibelt KK



optimat DE



optimat DK

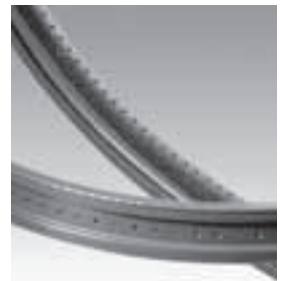

optimat FK



optibelt LB



optimax HF

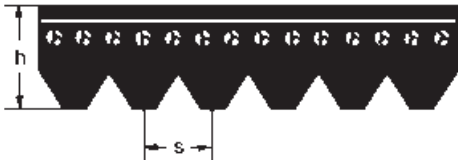

Profil Section	PH	PJ	PK
s =	1,6	2,34	3,56
h ≈	2,5	3,50	4,60

Profil Section PH (keine Lagerware non stock items)

Bezugslänge Effective length (mm)		Bezugslänge Effective length (Zoll inch)		Bezugslänge Effective length (mm)		Bezugslänge Effective length (Zoll inch)	
698	27,50	1096	43,10	1371	54,00		
735	28,90	1168	46,00	1397	55,00		
762	30,00	1194	47,00	1439	56,70		
813	32,00	1200	47,20	1475	58,10		
858	33,80	1222	48,10	1600	63,00		
864	34,00	1230	48,40	1854	73,00		
886	34,90	1262	49,70	1895	74,60		
914	36,00	1270	50,00	1915	75,40		
955	37,60	1285	50,60	1930	76,00		
965	38,00	1290	50,80	1956	77,00		
975	38,40	1301	51,20	1992	78,40		
990	39,00	1309	51,50	2083	82,00		
1016	40,00	1316	51,80	2155	84,80		
1080	42,50	1321	52,00				
1092	43,00	1333	52,50				

Gewicht Belt weight: 1 Rippe rib ≈ 0,005 kg/m

Profil Section PJ

Profil Section PK

Bezugslänge Effective length (mm)		Bezugslänge Effective length (Zoll inch)		Bezugslänge Effective length (mm)		Bezugslänge Effective length (Zoll inch)	
280	11,00	1244	49,00	630•	24,80	1397•	55,00
330	13,00	1262	49,70	648	25,50	1439•	56,70
356	14,00	1270	50,00	698	27,50	1460	57,50
362	14,30	1285	50,60	730	28,70	1520	59,80
381	15,00	1301	51,20	775	30,50	1560	61,40
406	16,00	1309	51,50	800	31,50	1570	61,80
414	16,30	1316	51,80	812	32,00	1600•	63,00
432	17,00	1321	52,00	830	32,70	1655	65,20
457	18,00	1333	52,50	865	34,00	1690	66,50
483	19,00	1355	53,40	875	34,50	1755	69,10
508	20,00	1371	54,00	890	35,00	1854•	73,00
559	22,00	1397	55,00	913	36,00	1885	74,20
584	23,00	1428	56,20	920	36,20	1930•	76,00
610	24,00	1439	56,70	940	37,00	1956•	77,00
660	26,00	1475	58,10	954	37,60	1980	78,00
711	28,00	1549	61,00	962	37,80	2030	79,90
723	28,50	1600	63,00	990	39,00	2050	80,70
762	30,00	1651	65,00	1015	40,00	2080	82,00
813	32,00	1663	65,50	1080	42,50	2120	83,50
836	32,90	1752	69,00	1090	43,00	2145	84,40
864	34,00	1780	70,00	1125	44,30	2170	85,40
914	36,00	1854	73,00	1150	45,30	2235•	88,00
955	37,60	1895	74,60	1165	45,90	2255	88,80
965	38,00	1910	75,20	1190	46,80	2362•	93,00
1016	40,00	1915	75,40	1200•	47,20	2460	96,90
1092	43,00	1930	76,00	1222•	48,10	2515•	99,00
1105	43,50	1956	77,00	1230•	48,40	2743•	108,00
1110	43,70	1965	77,40	1245	49,00	2845•	112,00
1123	44,20	1981	78,00	1270•	50,00		
1130	44,50	1992	78,40	1285•	50,60		
1150	45,30	2083	82,00	1290•	50,80		
1168	46,00	2155	84,80	1321•	52,00		
1194	47,00	2210	87,00	1330	52,40		
1200	47,30	2337	92,00	1345	53,00		
1222	48,10	2489	98,00	1371•	54,00		

Gewicht Belt weight: 1 Rippe rib ≈ 0,009 kg/m

Gewicht Belt weight: 1 Rippe rib ≈ 0,023 kg/m

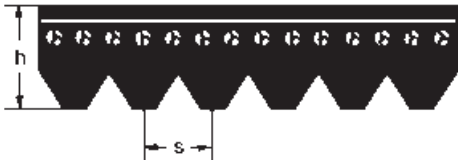

Profil Section	PL	PM
s =	4,7	9,4
h ≈	7,0	13,0

Profil Section PL				Profil Section PM			
Bezugslänge Effective length		Bezugslänge Effective length		Bezugslänge Effective length		Bezugslänge Effective length	
(mm)	(Zoll inch)	(mm)	(Zoll inch)	(mm)	(Zoll inch)	(mm)	(Zoll inch)
954	37,50	2362	93,00	2286	90,00	5029	198,00
991	39,00	2476	97,50	2388	94,00	5410	213,00
1075	42,30	2515	99,00	2515	99,00	6121	241,00
1194	47,00	2705	106,50	2693	106,00	6883•	271,00
1270	50,00	2743	108,00	2832	111,50	7646•	301,00
1333	52,50	2845	112,00	2921	115,00	8408•	331,00
1371	54,00	2895	114,00	3010	118,50	9169•	361,00
1397	55,00	2921	115,00	3124	123,00	9931•	391,00
1422	56,00	2997	118,00	3327	131,00	10693•	421,00
1562	61,50	3086	121,50	3531	139,00	12217•	481,00
1613	63,50	3124	123,00	3734	147,00	13741•	541,00
1664	65,50	3289	129,50	4089	161,00	15266•	601,00
1715	67,50	3327	131,00	4191	165,00		
1764	69,50	3492	137,50	4470	176,00		
1803	71,00	3696	145,50	4648	183,00		
1841	72,50	4051	159,50				
1943	76,50	4191	165,00				
1981	78,00	4470	176,00				
2020	79,50	4622	182,00				
2070	81,50	5029	198,00				
2096	82,50	5385	212,00				
2134	84,00	6096	240,00				
2197	86,50						
2235	88,00						
2324	91,50						
Gewicht Belt weight: 1 Rippe rib ≈ 0,041 kg/m				Gewicht Belt weight: 1 Rippe rib ≈ 0,114 kg/m			

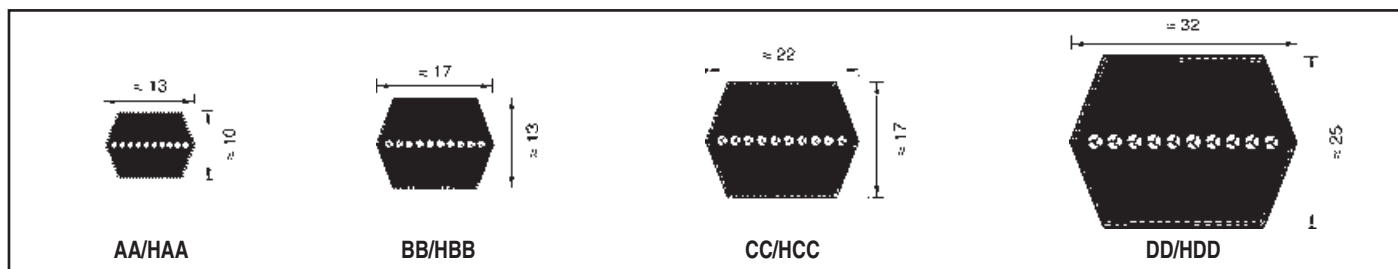

Profil Section AA/HAA		Profil Section BB/HBB		Profil Section CC/HCC		Profil Section DD/HDD	
Riemen-Nr. Belt no.	Bezugslänge Reference length (mm)	Riemen-Nr. Belt no.	Bezugslänge Reference length (mm)	Riemen-Nr. Belt no.	Bezugslänge Reference length (mm)	Riemen-Nr. Belt no.	Bezugslänge Reference length (mm)
AA 77	2000	BB 75	1980	CC 86	2280	Auf Anfrage <i>On request</i>	
AA 78	2032	BB 83	2180	CC 94	2500		
AA 91	2370	BB 88	2300	CC 106	2800		
AA 96	2500	BB 90	2370	CC 122	3200		
AA 102	2650	BB 95	2500	CC 126	3310		
AA 103	2667	BB 97	2540	CC 144	3765		
AA 108	2800	BB 99	2600	CC 153	4000		
AA 128	3300	BB 101	2650	CC 162	4216		
AA 152	3920	BB 105	2740	CC 165	4300		
		BB 107	2800	CC 173	4500		
		BB 109	2850	CC 193	5000		
		BB 112	2920	CC 204	5300		
		BB 115	3000	CC 206	5340		
		BB 116	3030	CC 224	5750		
		BB 121	3150				
		BB 125	3250				
		BB 126	3280				
		BB 128	3325				
		BB 131	3390				
		BB 133	3450				
		BB 135	3500				
		BB 137	3550				
		BB 144	3730				
		BB 145	3750				
		BB 155	4010				
		BB 156	4040				
		BB 162	4200				
		BB 173	4470				
		BB 174	4500				
		BB 184	4750				
		BB 194	5000				
		BB 221	5639				
				Gewicht <i>Belt weight</i> : ≈ 0,440 kg/m		Gewicht <i>Belt weight</i> : ≈ 0,935 kg/m	
				Profil Section 22 x 22		Profil Section 25 x 22	
						Auf Anfrage <i>On request</i>	
				5180			
				5220			
				5850			
				6270			
Gewicht <i>Belt weight</i> : ≈ 0,150 kg/m		Gewicht <i>Belt weight</i> : ≈ 0,250 kg/m		Gewicht <i>Belt weight</i> : ≈ 0,511 kg/m		Gewicht <i>Belt weight</i> : ≈ 0,625 kg/m	

<p>Zwischenlängen und Sonderausführungen ab:</p> <p>Profil AA/HAA 1350 bis 6000 mm Profil BB/HBB 1600 bis 12700 mm Profil CC/HCC 2000 bis 19500 mm Profil 22 x 22 auf Anfrage</p> <p><i>Non standard lengths available:</i></p> <p>Section AA/HAA 1350 up to 6000 mm Section BB/HBB 1600 up to 12700 mm Section CC/HCC 2000 up to 19500 mm Section 22 x 22 on request</p>	<p>Umrechnungswerte von der Riemen-Nr. zur Bezugslänge: <i>To convert from belt no. (that is theoretical inside length in inches) to reference length:</i></p> <p>Profil Section AA/HAA – Riemen-Nr. <i>belt no.</i> x 25,4 = mm + 53 mm</p> <p>Profil Section BB/HBB – (bis Riemen-Nr. up to belt no. 210) Riemen-Nr. <i>belt no.</i> x 25,4 = mm + 74 mm (über Riemen-Nr. over belt no. 210) Riemen-Nr. <i>belt no.</i> x 25,4 = mm + 36 mm</p> <p>Profil Section CC/HCC – (bis Riemen-Nr. up to belt no. 210) Riemen-Nr. <i>belt no.</i> x 25,4 = mm + 107 mm (über Riemen-Nr. over belt no. 210) Riemen-Nr. <i>belt no.</i> x 25,4 = mm + 56 mm</p> <p>Profil Section DD/HDD – (bis Riemen-Nr. up to belt no. 210) Riemen-Nr. <i>belt no.</i> x 25,4 = mm + 132 mm (über Riemen-Nr. over belt no. 210) Riemen-Nr. <i>belt no.</i> x 25,4 = mm + 69 mm</p>
---	---

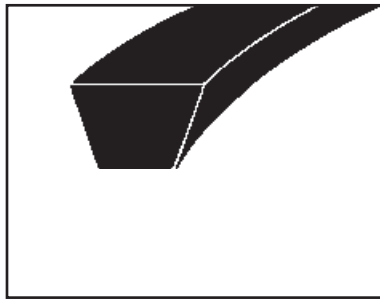

Profil Section	Breite x Höhe Width x Height (mm)	Rollenlänge Roll length (m)	Gewicht Weight (≈ kg/m)	transparent 87 Shore A	weiß white 92 Shore A	weiß white 98 Shore A
8	8 x 5	50	0,041	—	■	—
Z/10	10 x 6	50	0,055	■•	■	—
A/13	13 x 8	50	0,098	■•	■	■
B/17	17 x 11	50	0,173	■•	■	■
C/22	22 x 14	25	0,275	■•	■	—

optibelt KK Kunststoffkeilriemen mit Aufprofilierung (weiß, 92 Shore A)
Polyurethane V-Belts with Special Top Surfaces (white, 92 Shore A)
Kunststoffkeilriemen mit Spitzdachprofil Polyurethane V-Belts with Profiled Carrying Surfaces

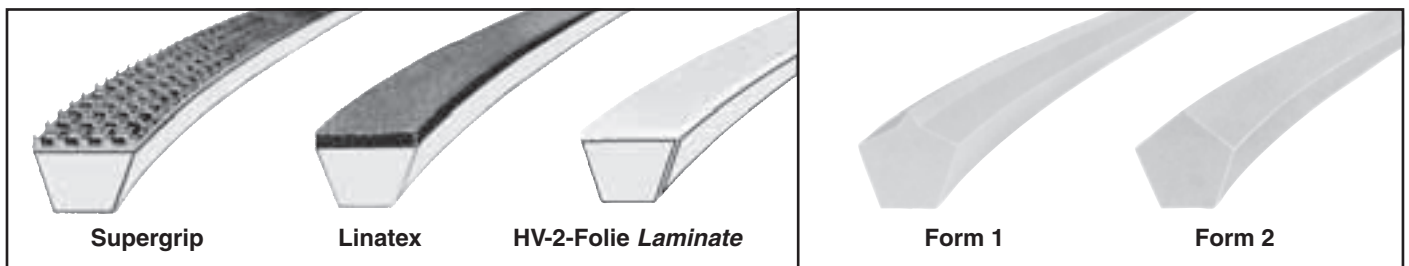

Profil Section	Breite x Höhe Width x Height (mm)	Rollenlänge Roll length (m)	Supergrip 92 Shore A	Linatex 92 Shore A	HV-2- Folie Laminate 92 Shore A	Form	Profil Section	Rollenlänge Roll length (m)	Spitzdachprofil Profiled carrying surface
8	8 x 5	50	■•	■•	■•	1	A/13	50	■
Z/10	10 x 6	50	■	■	■•	2	A/13	25	■
A/13	13 x 8	50	■	■	■•	1	B/17	50	■
B/17	17 x 11	50	■	■	■•	2	B/17	25	■
C/22	22 x 14	25	■•	■•	■•	1	C/22	25	■
						2	C/22	25	■

• Keine Lagerware. Mindest-Abnahmemenge auf Anfrage.
Mindest-Abnahmemenge für Lagerware: 25 m

Kunststoffkeilriemen mit Supergrip-Auflage

Produktbeschreibung: weiß, ca. 92 Shore A
Standard-Aufprofilierung: Supergrip, grün – PVC
Spezial-Aufprofilierungen: auf Anfrage

Kunststoffkeilriemen mit Linatex-Auflage

Produktbeschreibung: weiß, ca. 92 Shore A
Aufprofilierung: Linatex, rot

Kunststoffkeilriemen mit HV-2-Folie

Produktbeschreibung: weiß, ca. 92 Shore A
Aufprofilierung: HV-2-Folie, transparent

Kunststoffkeilriemen mit Spitzdachprofil

Produktbeschreibung: Form 1 und 2 weiß,
ca. 92 Shore A

• Non stock items. Minimum order quantity on request.
Minimum order quantity for stock items: 25 m

Polyurethane V-belts with Supergrip surface

Product description: white, approx. 92 Shore A
Standard surface: Supergrip, green – PVC
Special surfaces: on request

Polyurethane V-belts with Linatex surface

Product description: white, approx. 92 Shore A
Surface: Linatex, red

Polyurethane V-belts with HV-2-Laminate

Product description: white, approx. 92 Shore A
Surface: HV-2-Laminate, transparent

Polyurethane V-belts ridge top

Product description: Form 1 and 2 white,
approx. 92 Shore A

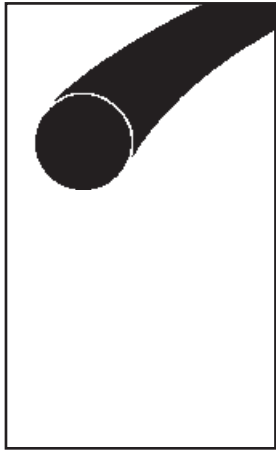

Durchmesser Diameter (mm)	Rollenlänge Roll length (m)	Gewicht Weight (≈ kg/m)	schwarz black 65 Shore A	gelb yellow 82 Shore A	orange orange 85 Shore A	grün – glatt green – smooth 88 Shore A	grün – rau green – rough 88 Shore A	weiß white 92 Shore A	blau blue 98 Shore A
2	200	0,004	—	■•	■•	■	■	■•	■•
3	200	0,009	—	■•	■•	■	■	■•	■•
4	200	0,016	—	■•	■•	■	■	■•	■•
5	200	0,024	—	■•	■•	■	■	■•	■•
6	100	0,035	■•	■•	■•	■	■	■•	■•
7	100	0,048	■•	■•	■•	■	■	■•	■•
8	100	0,064	■•	■•	■•	■	■	■•	■•
10	100	0,096	■•	■•	■•	■	■	■•	■•
12	50	0,132	■•	■•	■•	■	■	■•	■•
15	50	0,211	—	■•	■•	■	■	■•	■•
18	30	0,305	—	—	—	■	■	■•	■•

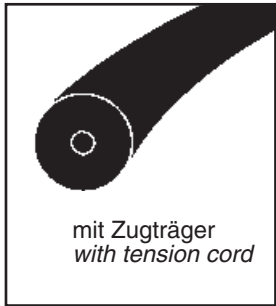

Durchmesser Diameter (mm)	Rollenlänge Roll length (m)	Gewicht Weight (≈ kg/m)	schwarz black 65 Shore A	gelb yellow 82 Shore A	orange orange 85 Shore A	grün – glatt green – smooth 88 Shore A	grün – rau green – rough 88 Shore A	weiß white 92 Shore A	blau blue 98 Shore A
6	100	0,035	—	■•	—	■•	■•	■•	■•
7	100	0,048	—	■•	—	■•	■•	■•	■•
8	100	0,064	—	■•	—	■•	■•	■•	■•
10	100	0,096	—	■•	—	■•	■•	■•	■•
12	50	0,132	—	■•	—	■•	■•	■•	■•
15	50	0,211	—	■•	—	■•	■•	■•	■•

• Keine Lagerware, Mindest-Abnahmemenge auf Anfrage.
 Mindestabnahme für Lagerware: 30 m

• Non stock items, minimum order quantity on request.
 Minimum order quantity for stock items: 30 m

Mindestlängen für Endlosverbindung
 Minimum lengths for endless connection: 200 mm

Verbindungswerkzeuge Splicing Tools (bis Profil up to section C/22)

Für Keilriemen und Rundriemen ab Ø 8 mm
 For V-belt and round section belting from Ø 8 mm



Führungszange
 Guiding tongs B 2

Für Keilriemen und Rundriemen bis Profil Z/10
 For V-belt and round section belting up to section Z/10



Führungszange
 Guiding tongs B 3

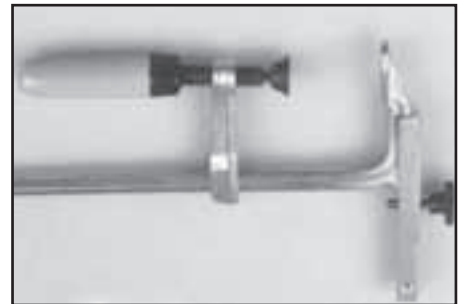

Tischbefestigung für Führungszange
 Table attachment for guiding tongs



Schweißgerät incl. Spiegel
 Welding tool incl. welding plate



Ersatzspiegel
 Welding plate



Schere mit Anschlag
 Shears

optimat DE Endliche Keilriemen DIN 2216, gelocht
Open-Ended V-Belts DIN 2216, Punched

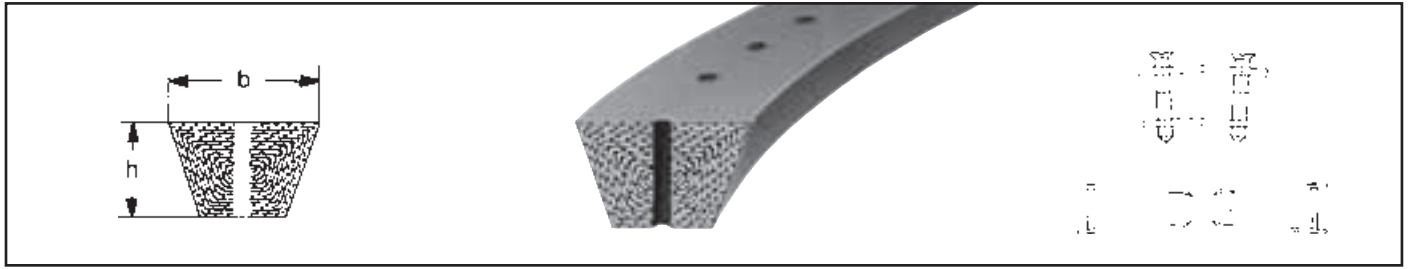

Profil Section	Breite x Höhe Width x Height (mm)	Gewicht Weight (≈ kg/m)	Standard grüne Deckbänder green top surface	Polyester rote Deckbänder red top surface	Plattenverbinder Plate connectors		Gelenkverbinder Link connectors		Min.-Scheibendurchmesser Min. pulley diameter (mm)
					Gewicht Weight (≈ kg/ 100 Stück pieces)	Gewicht Weight (≈ kg/ 100 Stück pieces)	Gewicht Weight (≈ kg/ 100 Stück pieces)	Gewicht Weight (≈ kg/ 100 Stück pieces)	
Y/6	6 x 4	0,030	■	■	0,1	■	—	—	50
8	8 x 5	0,050	■	■	0,2	■	—	—	63
Z/10	10 x 6	0,070	■	■	0,3	■	0,7	■	80
A/13	13 x 8	0,120	■	■	0,5	■	1,8	■	100
B/17	17 x 11	0,200	■	■	0,8	■	2,9	■	140
20	20 x 12,5	0,270	■	■	1,4	■	4,6	■	180
C/22	22 x 14	0,340	■	■	1,7	■	5,7	■	224
25	25 x 16	0,440	■	■•	2,1	■	5,7	■○	250
D/32	32 x 20	0,680	■	■•	5,0	■	—	—	355
E/40	40 x 25	1,000	■•	■•	10,0	■○	—	—	500

Sonderausführungen

Ausführung „S“ mit schwarzen Chloropren-Deckbändern lieferbar.

- Keine Lagerware
- Auslaufartikel

Special constructions

Construction „S“ with black chloroprene top surface available.

- Non stock items
- These items will be discontinued when present stock is depleted.

optimat DK Endliche Doppelkeilriemen, gelocht
Open-Ended Double V-Belts, Punched

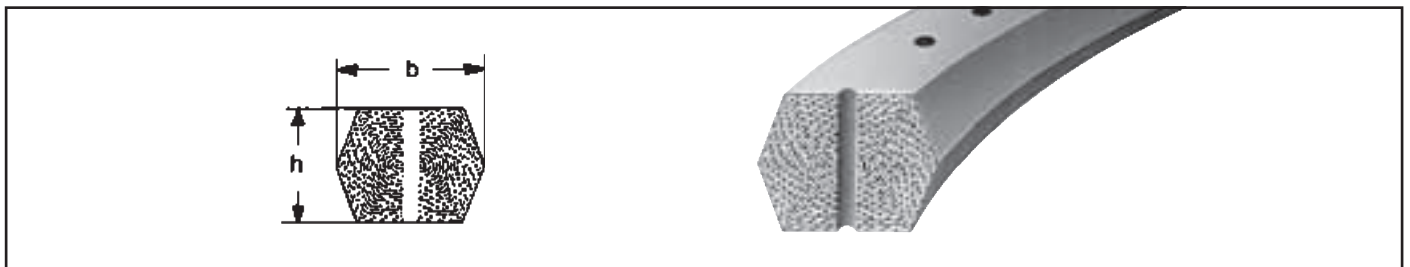

Profil Section	Breite x Höhe Width x Height (mm)	Gewicht Weight (≈ kg/m)	Standard grüne Deckbänder green top surface	Plattenverbinder Plate connectors		Gelenkverbinder Link connectors		Min.-Scheibendurchmesser Min. pulley diameter (mm)
				Gewicht Weight (≈ kg/ 100 Stück pieces)	Gewicht Weight (≈ kg/ 100 Stück pieces)	Gewicht Weight (≈ kg/ 100 Stück pieces)	Gewicht Weight (≈ kg/ 100 Stück pieces)	
AA/13	13 x 10,5	0,140	■	0,6	■	1,7	■	140
BB/17	17 x 14	0,250	■	1,2	—	2,6	■	160
20	20 x 16	0,320	■•	1,6	—	3,7	—	200
CC/22	22 x 18	0,410	■	2,2	■	4,4	—	224

Sonderausführungen

Ausführung „S“ mit schwarzen Chloropren-Deckbändern lieferbar.

- Keine Lagerware

Special constructions

Construction „S“ with black chloroprene top surface available.

- Non stock items

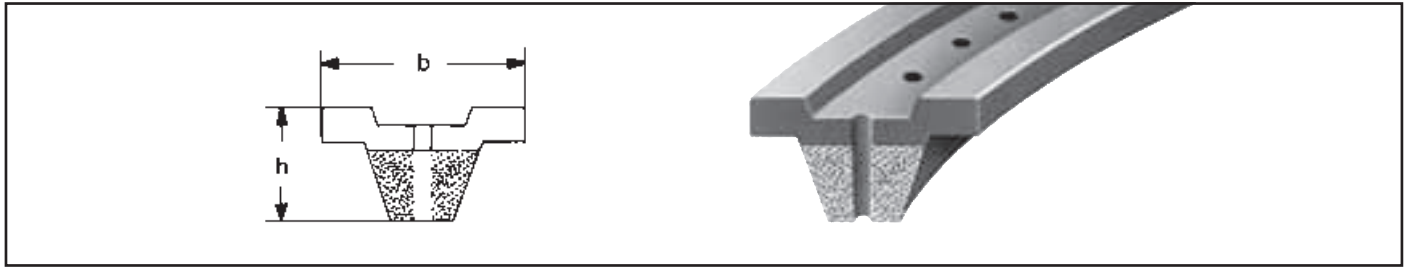

Profil Section	Breite x Höhe Width x Height (mm)	Gewicht Weight (≈ kg/m)	Standard			Polyester	
			grün <i>green</i>	braun <i>brown</i> , abriebfest, ölbeständig <i>abrasion and oil resistant</i>	weiß <i>white</i> , abriebfest <i>abrasion resistant</i>	braun <i>brown</i> , abriebfest, ölbeständig <i>abrasion and oil resistant</i>	weiß <i>white</i> , abriebfest <i>abrasion resistant</i>
13 x 20	20 x 16,5	0,32	■	■	■•	■•	■•
17 x 30	30 x 20	0,46	■	■	■•	■•	■•
22 x 40	40 x 24	0,74	■	■	■•	■•	■•
32 x 60	60 x 33	1,30	■•	■•	■•	■•	■•

Profil Section	Breite x Höhe Width x Height (mm)	Plattenverbinder <i>Plate connectors</i>		Gelenkverbinder <i>Link connectors</i>		Mindest- Scheiben- durchmesser <i>Minimum pulley diameter</i> (mm)
		Gewicht <i>Weight</i> (≈ kg/100 Stück <i>pieces</i>)		Gewicht <i>Weight</i> (≈ kg/100 Stück <i>pieces</i>)		
13 x 20	20 x 16,5	0,6	■○	2,6	—	140
17 x 30	30 x 20	0,9	■	3,7	—	160
22 x 40	40 x 24	1,8	■○	5,4	—	250
32 x 60	60 x 33	5,6	■○	5,7	—	450

Optimat Keilriemen OE, DK und FK werden in Rollenlängen von ca. 50 m hergestellt.
Optimat belting OE, DK and FK are supplied in lengths of approx. 50 metres.

- Keine Lagerware, Mindestmenge *Non stock items, minimum order quantity*: 1 Rolle *roll*.
- Auslaufartikel *These items will be discontinued when present stock is depleted*.

optimat PKR Endliche Keilriemen DIN 2216 mit Auflage
 Open-Ended V-Belts DIN 2216 with Special Top Surfaces



Profil Section	PKR 0		PKR 1		PKR 2	
	S	P	S	P	S	P
Z/10	■	■	—	—	—	—
A/13	■	■	■	■	■	■
B/17	■	■	■	■	■	■
C/22	■	■	■	■	■	■
25•	■	■	■	■	■	■
D/32•	■	■	■	■	—	—

S = Standard; P = Polyester

• Sonderausführungen sind **nur** in Fertigungslängen von ca. 50 m lieferbar. *Special constructions are only available in lengths of approx. 50 metres.*

Profilierungsarten Patterns	Höhe der Auflage Height of patterns		Teilung Pitch (mm)
	Standard (mm)	max. (mm)	
PKR 0	2	3	—
PKR 1♦	3	3	10
PKR 2	3	—	—

♦ Für Profile 25 und D/32 Höhe der Auflage nur 5 mm möglich
Sections 25 and D/32 height of patterns only 5 mm possible

Qualität/Farbe Quality/Colour	Temperaturbeständigkeit Temper. resistance (°C)	Härte Hardness (Shore A)	Ölbeständig Oil resistant	Abfärbend Staining
PKR 0				
CR/rotbraun red brown	-25 bis to +100	≈ 50	bedingt limited	nein no
SBR-NR/hell light	-40 bis to + 70	≈ 45	nein no	nein no
PKR 1 und and PKR 2				
NR/rotbraun red brown	-40 bis to + 70	≈ 48	nein no	nein no
SBR-NR/hell light	-40 bis to + 70	≈ 45	nein no	nein no
CR/rotbraun red brown	-25 bis to +100	≈ 50	bedingt limited	nein no
CR/schwarz black	-25 bis to +100	≈ 68	bedingt limited	ja yes

optibelt LB Gliederkeilriemen (Polyurethan mit Polyester-Gewebeeinlagen)
 Link Belts (Construction: Polyurethane with Polyester Laminations)

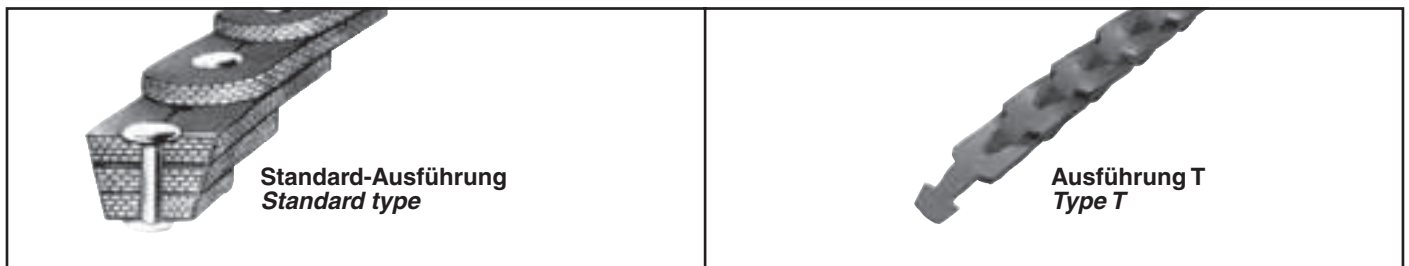

Profil Section (Standard)	Gewicht Weight ≈ (kg/m)		Profil Section (Type T)	Gewicht Weight ≈ (kg/m)	
8	0,120	■	8 T	0,116	■
Z/10	0,135	■	10 T	0,131	■
A/13	0,163	■	13 T	0,158	■
B/17	0,230	■	17 T	0,223	■
			22 T	0,359	■

Weitere Profile und Ausführungen auf Anfrage.
 Optibelt LB Gliederkeilriemen werden in Rollen zu je 20 m, im Karton verpackt, geliefert.
 Jeder Karton im Profil 13 und 17 enthält ein kostenloses Verbindungswerkzeug für die Standard-Ausführung.

*Further sections and constructions on request.
 Optibelt LB is supplied in boxes containing rolls of 20 metres.
 Each box of section 13 and 17 is delivered with a free splicing tool.*

optibelt RF Gummigewebetreibriemen Type B 50 (keine Lagerware)
Rubber Covered Flat Belts Type B 50 (Non Stock Items)

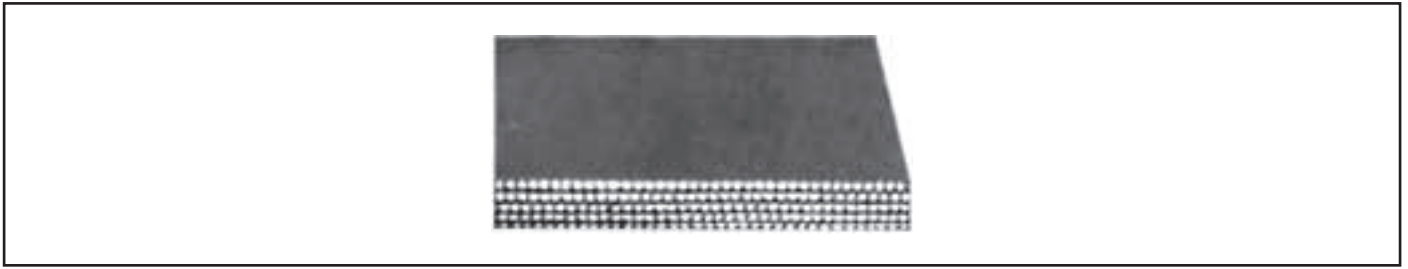

Breite <i>Width</i> (mm)	20; 25; 30; 35; 40; 50; 60; 70; 80; 90; 100; 110; 115; 120; 130; 140; 150; 160; 170; 180; 190; 200; 220; 230; 240; 250; 280; 300; 400; 500; 1000		
	Dicke <i>Thickness</i> ≈ (mm)	Gewicht <i>Weight</i> ≈ (kg/m ²)	Min.-Scheibendurchmesser <i>Min. pulley diameter</i> (mm)
3 Lagen <i>plies</i>	3,6	3,8	89
4 Lagen <i>plies</i>	4,8	5,1	120

Weitere Breiten und Endlosverbindungen auf Anfrage.
 Rollenlänge: 50 m

*Further widths and endless connectors on request.
 Length of roll: 50 metres*

Mindestlänge für Endlos-Vulkanisation: 1450 mm
 Verkleben und Hakenverbindung für kürzere Längen möglich.

*Minimum length for vulcanising endless: 1450 mm
 Shorter lengths are possible using adhesives or fasteners.*

optibelt CF Seilcordflachriemen (keine Lagerware)
Cable Cord Flat Belts (Non Stock Items)

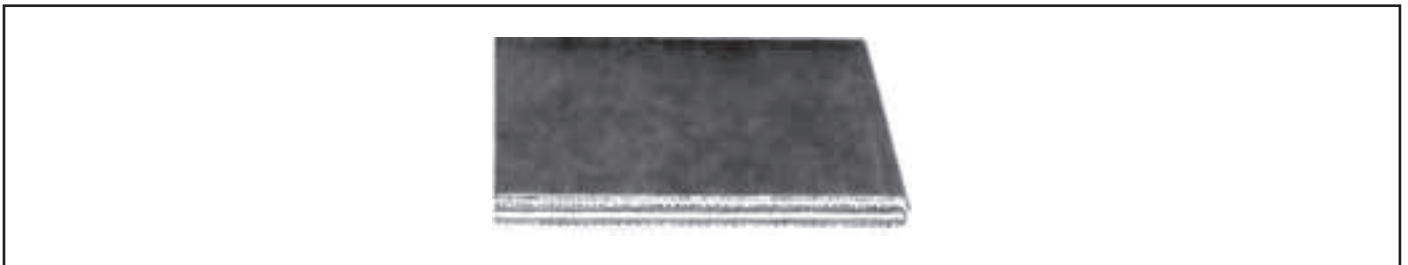

Breite <i>Width</i> (mm)	Gewicht <i>Weight</i> ≈ (kg/m)
60	0,36
70	0,42
80	0,48
90	0,54
100	0,60
110	0,66
120	0,72
130	0,78
140	0,84
150	0,90
160	0,96
170	1,02

Minimale Breite: 30 mm Max. Breite: 550 mm Minimale Länge: 1000 mm Max. Länge: 23000 mm Mindest-Abnahmemenge: 2 Stück	<i>Minimum width: 30 mm Max. width: 550 mm Minimum length: 1000 mm Max. length: 23000 mm Minimum order quantity: 2 pieces</i>
---	---

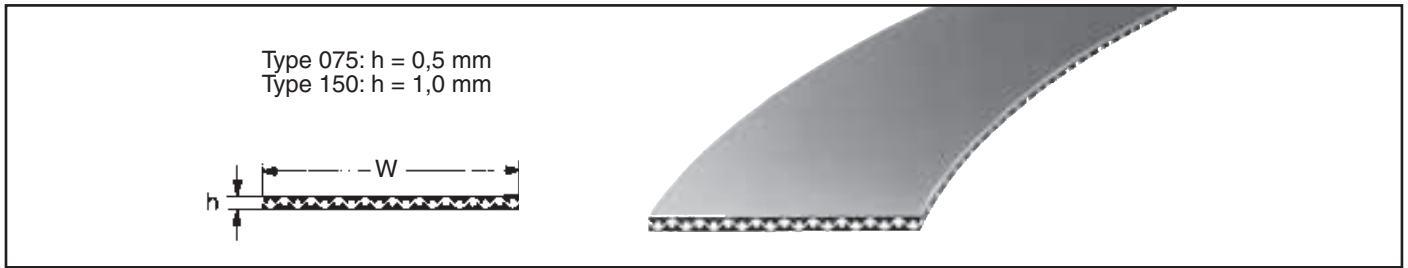

Optimax HF Type 075, Type 150 Standard-Sortiment <i>Standard range</i> Optimax HF Type 150 (L _i mm)								
400	650	890	1130	1380	1630	1890	2210	2700
410	660	900	1140	1390	1640	1900	2220	2750
420	670	910	1150	1400	1650	1920	2240	2780
430	680	920	1160	1410	1660	1930	2250	2800
440	690	930	1170	1420	1670	1940	2270	2850
450	695	935	1180	1430	1680	1950	2280	2900
460	700	940	1190	1440	1700	1960	2290	2950
470	710	950	1200	1450	1710	1970	2300	3000
480	720	960	1210	1460	1720	1980	2320	3050
490	730	970	1220	1470	1730	2000	2340	3100
500	740	980	1230	1480	1740	2020	2350	3150
510	750	990	1240	1490	1750	2030	2370	3200
520	760	1000	1250	1500	1760	2040	2380	3250
530	770	1010	1260	1510	1770	2050	2400	3300
540	780	1020	1270	1520	1780	2060	2430	3400
550	790	1030	1280	1530	1790	2070	2440	3500
560	800	1040	1290	1540	1800	2090	2450	3600
570	810	1050	1300	1550	1810	2100	2480	
580	820	1060	1310	1560	1820	2110	2500	
590	830	1070	1320	1570	1830	2120	2520	
600	840	1080	1330	1580	1840	2130	2550	
610	850	1090	1340	1590	1850	2140	2570	
620	860	1100	1350	1600	1860	2150	2600	
630	870	1110	1360	1610	1870	2190	2650	
640	880	1120	1370	1620	1880	2200	2660	

Standardbreiten *Standard widths*: 10; 15; 20; 25; 30; 35; 40; 50; 60; 70; 80; 90; 100

Type 150: ab Lager lieferbar *delivery ex stock*; Type 075: keine Lagerware *non stock items*

<p>Breiten Dieses Standard-Sortiment kann in jeder beliebigen Breite bis max. 420 mm geliefert werden.</p> <p>Zwischenlängen Außer diesen Standardlängen kann auf Anfrage jede Länge zwischen 150 und 3800 mm geliefert werden.</p> <p>Weitere Qualitäten und Sonderausführungen auf Anfrage.</p> <p>Aufpreis für Mindermengen Type 150: 1 bis 5 Stück = 25 %</p> <p>Mindest-Abnahmemenge Type 075: 1 Wickel = 420 mm ± 10 %</p> <p>Toleranzen a) Längentoleranz: ± 1 %, mindestens ± 3 mm b) Breitentoleranz: ± 0,5 mm, bis auf ± 0,2 mm reduzierbar</p> <p>Gewicht Type 075 ≈ 0,620 kg/m² Type 150 ≈ 1,210 kg/m²</p>	<p>Widths <i>Above length range can be supplied in every width up to max. 420 mm.</i></p> <p>Intermediate lengths <i>As well as standard lengths, intermediate lengths between 150 and 3800 mm can be supplied on request.</i></p> <p>Further qualities and special constructions on request.</p> <p>Minimum order quantity surcharge <i>Type 150: 1 up to 5 pieces = 25 %</i></p> <p>Minimum order quantity <i>Type 075: 1 sleeve = 420 mm ± 10 %</i></p> <p>Tolerances a) <i>Length tolerance: ± 1 %, minimum ± 3 mm</i> b) <i>Width tolerance: ± 0.5 mm, reducible down to ± 0.2 mm</i></p> <p>Weight <i>Type 075 ≈ 0.620 kg/m² Type 150 ≈ 1.210 kg/m²</i></p>
---	--

optibelt WR Weitwinkelriemen aus Polyurethan (Winkel 60°)
Polyurethane Wide-Angle Belts (60°)

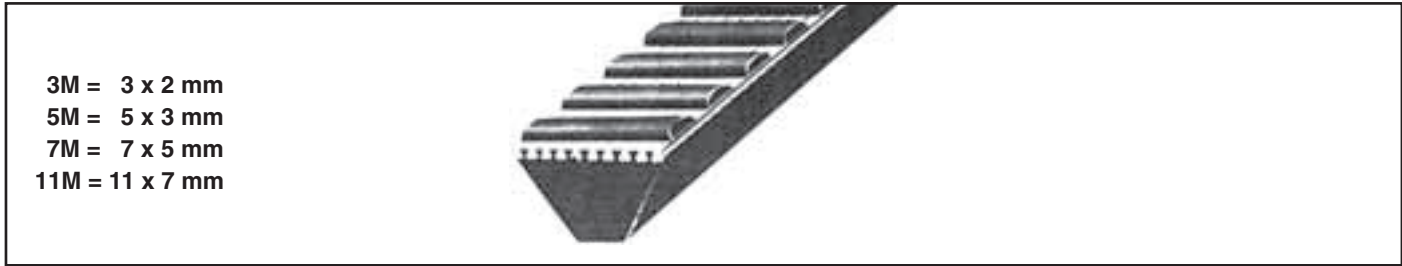

Außenlänge Outs. length (mm)	Profil Sect. 3M	Profil Sect. 5M	Profil Sect. 7M	Profil Sect. 11M	Außenlänge Outs. length (mm)	Profil Sect. 3M	Profil Sect. 5M	Profil Sect. 7M	Profil Sect. 11M
180	■•	—	—	—	650	■•	■	■	—
185	■•	—	—	—	670	■•	■	■	—
190	■•	—	—	—	690	■•	■	■	—
195	■•	—	—	—	710	■•	■	■	■
200	■•	—	—	—	730	■•	■	■	■
206	■•	—	—	—	750	■•	■	■	■
212	■•	—	—	—	775	—	■	■	■
218	■•	—	—	—	800	—	■	■	■
224	■•	—	—	—	825	—	■	■	■
230	■•	—	—	—	850	—	■	■	■
236	■•	—	—	—	875	—	■	■	■
243	■•	—	—	—	900	—	■	■	■
250	■•	—	—	—	925	—	■	■	■
258	■•	—	—	—	950	—	■	■	■
265	■•	—	—	—	975	—	■	■	■
272	■•	—	—	—	1000	—	■	■	■
280	■•	■	—	—	1030	—	■	■	■
290	■•	■	—	—	1060	—	■	■	■
300	■•	■	—	—	1090	—	■	■	■
307	■•	■	—	—	1120	—	■	■	■
315	■•	■	—	—	1150	—	■	■	■
325	■•	■	—	—	1180	—	■	■	■
335	■•	■	—	—	1220	—	■	■	■
345	■•	■	—	—	1250	—	■	■	■
355	■•	■	—	—	1280	—	■	■	■
365	■•	■	—	—	1320	—	■	■	■
375	■•	■	—	—	1360	—	■	■	■
387	■•	■	—	—	1400	—	■	■	■
400	■•	■	—	—	1450	—	■	■	■
412	■•	■	—	—	1500	—	■	■	■
425	■•	■	—	—	1550	—	—	■	■
437	■•	■	—	—	1600	—	—	■	■
450	■•	■	—	—	1650	—	—	■	■
462	■•	■	—	—	1700	—	—	■	■
475	■•	■	—	—	1750	—	—	■	■
487	■•	■	—	—	1800	—	—	■	■
500	■•	■	■	—	1850	—	■	■	■
515	■•	■	■	—	1900	—	—	■	■
530	■•	■	■	—	1950	—	—	■	■
545	■•	■	■	—	2000	—	—	■	■
560	■•	■	■	—	2060	—	—	■	■
580	■•	■	■	—	2120	—	—	■	■
600	■•	■	■	—	2180	—	—	■	■
615	■•	■	■	—	2240	—	—	■	■
630	■•	■	■	—	2300	—	—	■	■

Metall *Metal*

optibelt

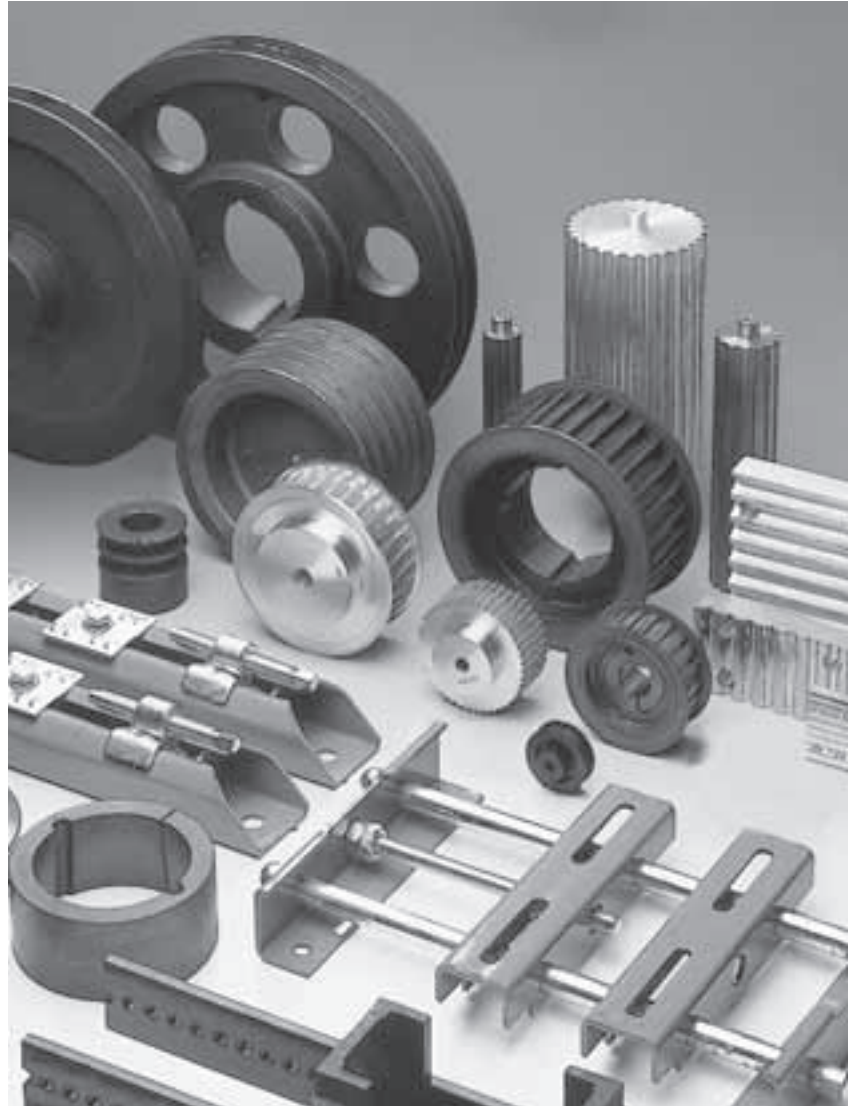

Metall

5

Metal

optibelt TB
Taper-Buchsen 89

Ausführungen der **optibelt K5**
Keilrillenscheiben, Auswuchten,
Aufschläge für Fertigbohrungen 90

optibelt K5
Keilrillenscheiben
für Taper-Buchsen –
Rillen nach DIN 2211 91-98

optibelt K5
Keilrillenscheiben
für zylindrische Bohrung –
Rillen nach DIN 2211 99-104

optibelt RE
Regelscheiben 105-107

optibelt RBS
Keilrippenscheiben
für Taper-Buchsen 108-112

optibelt RBS
Keilrippenscheiben
für zylindrische Bohrung 112

optibelt F5
Flachriemenscheiben
für Taper-Buchsen 113

optibelt M5
Motorspannschienen 114

optibelt M5
Motorspannschlitten 115

optibelt ZRS
Standard-Zahnscheiben
für zylindrische Bohrung 116-121

optibelt ZRS
Standard-Zahnscheiben
für Taper-Buchsen 122-127

optibelt ZRS
HTD®-Zahnscheiben
für zylindrische Bohrung 128-135

optibelt ZRS
HTD®-Zahnscheiben
für Taper-Buchsen 136-141

optibelt ZRS
Metrische Zahnscheiben
für zylindrische Bohrung, T-Type 142-146

optibelt ZRS
Metrische Zahnscheiben
für zylindrische Bohrung, AT-Type 147-150

optibelt ZRW
Standard-Zahnwellen 151-152

optibelt ZRW
Metrische Zahnwellen 153-154

optibelt TN
Tapernaben 155

optibelt TN
Zwischenhülsen 156

optibelt CE
Spannelemente 157-172

optibelt TB
Taper bushes 89

Types of **optibelt K5**
V-grooved pulleys, balancing,
surcharges for finished bores 90

optibelt K5
V-grooved pulleys
for taper bushes –
grooves to ISO/BS/DIN 91-98

optibelt K5
V-grooved pulleys
for plain boring –
grooves to ISO/BS/DIN 99-104

optibelt RE
Variable speed pulleys 105-107

optibelt RBS
Ribbed belt pulleys
for taper bushes 108-112

optibelt RBS
Ribbed belt pulleys
for plain boring 112

optibelt F5
Flat belt pulleys
for taper bushes 113

optibelt M5
Motor slide rails 114

optibelt M5
Motor slide bases 115

optibelt ZRS
Timing belt pulleys
for plain boring 116-121

optibelt ZRS
Timing belt pulleys
for taper bushes 122-127

optibelt ZRS
HTD® pulleys
for plain boring 128-135

optibelt ZRS
HTD® pulleys
for taper bushes 136-141

optibelt ZRS
Metric timing belt pulleys
for plain boring, T sections 142-146

optibelt ZRS
Metric timing belt pulleys
for plain boring, AT sections 147-150

optibelt ZRW
Timing bars – standard timing belts 151-152

optibelt ZRW
Timing bars – metric timing belts 153-154

optibelt TN
Taper hubs 155

optibelt TN
Adapters 156

optibelt CE
Clamping bushes 157-172

Taper-Buchsen mit metrischer Bohrung, Nut nach DIN 6885 Teil 1 Taper bushes with metric bores. Keyways to DIN 6885 Part 1																
	Taper-Buchse Taper bush															Material: EN-GJL 200 – DIN EN 1561
	1008	1108	1210	1215	1310	1610	1615	2012	2517	3020	3030	3525	3535	4040	4545	5050
Bohrungs- durch- messer Bore diameter d ₂ (mm)	10	10	11	11	14	14	14	14	16	25	35	35	35	40	55	70
	11	11	12	12	16	16	16	16	18	28	38	38	38	42	60	75
	12	12	14	14	18	18	18	18	19	30	40	40	40	45	65	80
	14	14	16	16	19	19	19	19	20	32	42	42	42	48	70	85
	16	16	18	18	20	20	20	20	22	35	45	45	45	50	75	90
	18	18	19	19	22	22	22	22	24	38	48	48	48	55	80	95
	19	19	20	20	24	24	24	24	25	40	50	50	50	60	85	100
	20	20	22	22	25	25	25	25	28	42	55	55	55	65	90	105
	22	22	24	24	28	28	28	28	30	45	60	60	60	70	95	110
	24▲	24	25	25	30	30	30	30	32	48	65	65	65	75	100	115
	25▲	25	28	28	32	32	32	32	35	50	70	70	70	80	105	120
		28▲	30	30	35	35	35	35	38	55	75	75	75	85	110	125
			32	32		38	38	38	40	60	80	80	80	90		
						40	40	40	42	65	85	85	85	95		
						42▲	42▲	42	45	70	90	90	90	100		
								45	75							
								48								
								50								
								50								
								60								
Anzug Tighten- ing torque (N _m)	5,7	5,7	20	20	20	20	20	31	49	92	92	115	115	172	195	275
Buchsenlänge Bush length (mm)	22,3	22,3	25,4	38,1	25,4	25,4	38,1	31,8	44,5	50,8	76,2	63,5	88,9	101,6	114,3	127,0
Gewicht bei Weight at d _{2 min} (≈ kg)	0,12	0,16	0,28	0,39	0,32	0,41	0,60	0,75	1,06	2,50	3,75	3,90	5,13	7,68	12,70	15,17

▲ Diese Bohrung ist mit Flachnut ausgeführt. *These bores have shallow keyways.*

Flachnute für Taper-Buchsen Shallow keyways for taper bushes

Bohrungsdurchm. Bore diameter d ₂ (mm)	Nutbreite Keyway width b (mm)	Nuttiefe Keyway depth t ₂ (mm)	Bohrungsdurchm. Bore diameter d ₂ (mm)	Nutbreite Keyway width b (mm)	Nuttiefe Keyway depth t ₂ (mm)
24	8	2,0	28	8	2,0
25	8	1,3	42	12	2,2

Taper-Buchsen mit Zoll-Bohrung, Nut nach Britischem Standard BS 46 Teil 1 Taper bushes with inch bores. Keyways to BS 46 Part 1																	
	Taper-Buchse Taper bush															Material: EN-GJL 200 – DIN EN 1561	
	1008	1108	1210	1215	1310	1610	1615	2012	2517	3020	3030	3525	3535	4040	4545	5050	
Bohrungs- durch- messer Bore diameter d ₂ (Zoll inch)	3/8*	3/8*	1/2	5/8*	1/2*	1/2	1/2	5/8*	3/4	1 1/4	1 1/4	1 1/2*	1 1/2	1 3/4*	2 1/4*	3*	
	1/2	1/2	5/8	3/4	5/8*	5/8	5/8	3/4	7/8	1 3/8	1 3/8	1 5/8*	1 5/8	1 7/8*	2 3/8*	3 1/4*	
	5/8	5/8	3/4	7/8	3/4*	3/4	3/4	7/8	1	1 1/2	1 1/2	1 3/4*	1 3/4	2*	2 1/2*	3 1/2*	
	3/4	3/4	7/8	1	7/8*	7/8	7/8*	1	1 1/8	1 5/8	1 5/8	1 7/8*	1 7/8	2 1/8*	2 3/4*	3 3/4*	
	7/8*	7/8	1	1 1/8	1*	1	1	1 1/8	1 1/4	1 3/4*	1 3/4*	2*	2	2 1/4*	2 7/8*	4*	
	1▲	1	1 1/8	1 1/4	1 1/8	1 1/8	1 1/8	1 1/4	1 1/4	1 3/8	1 7/8	1 7/8	2 1/8*	2 1/8	2 3/8*	3*	4 1/4*
		1 1/8▲*	1 1/4		1 1/4	1 1/4	1 1/4	1 3/8	1 1/2	1 5/8	2	2	2 1/4*	2 1/4	2 1/2*	3 1/4*	4 1/2*
					1 3/8	1 3/8	1 3/8	1 1/2	1 5/8	1 3/4	2 1/8*	2 1/8*	2 3/8*	2 3/8	2 5/8*	3 3/8*	4 3/4*
						1 1/2	1 1/2	1 5/8	1 3/4	1 7/8	2 1/4	2 1/4	2 1/2*	2 1/2	2 3/4*	3 1/2*	5*▲
						1 5/8	1 5/8	1 5/8▲*	1 3/4	1 7/8	2 3/8	2 3/8	2 5/8*	2 5/8	2 7/8*	3 3/4*	
									1 7/8	2	2 1/2	2 1/2	2 3/4*	2 3/4	3*	4*	
									2	2 1/8	2 5/8	2 5/8*	2 7/8*	2 7/8	3 1/8*	4 1/4*▲	
									2 1/4	2 3/8	2 3/4	2 3/4*	3*	3	3 1/4*	4 1/2*▲	
									2 3/8	2 7/8	3	3	3 1/8*	3 1/8	3 3/8*		
									2 1/2				3 1/4*	3 1/4	3 1/2*		
												3 3/8*	3 3/8	3 3/4*▲			
												3 1/2▲*	3 1/2▲	4*▲			
Anzug Tighten- ing torque (N _m)	5,7	5,7	20	20	20	20	20	31	49	92	92	115	115	172	195	275	
Buchsenlänge Bush length (mm)	22,3	22,3	25,4	38,1	25,4	25,4	38,1	31,8	44,5	50,8	76,2	63,5	88,9	101,6	114,3	127,0	
Gewicht bei Weight at d _{2 min} (≈ kg)	0,12	0,16	0,28	0,39	0,32	0,41	0,60	0,75	1,06	2,50	3,75	3,90	5,13	7,68	12,70	15,17	

* Keine Lagerware Non stock items

▲ Diese Bohrung ist mit Flachnut ausgeführt. *These bores have shallow keyways.*

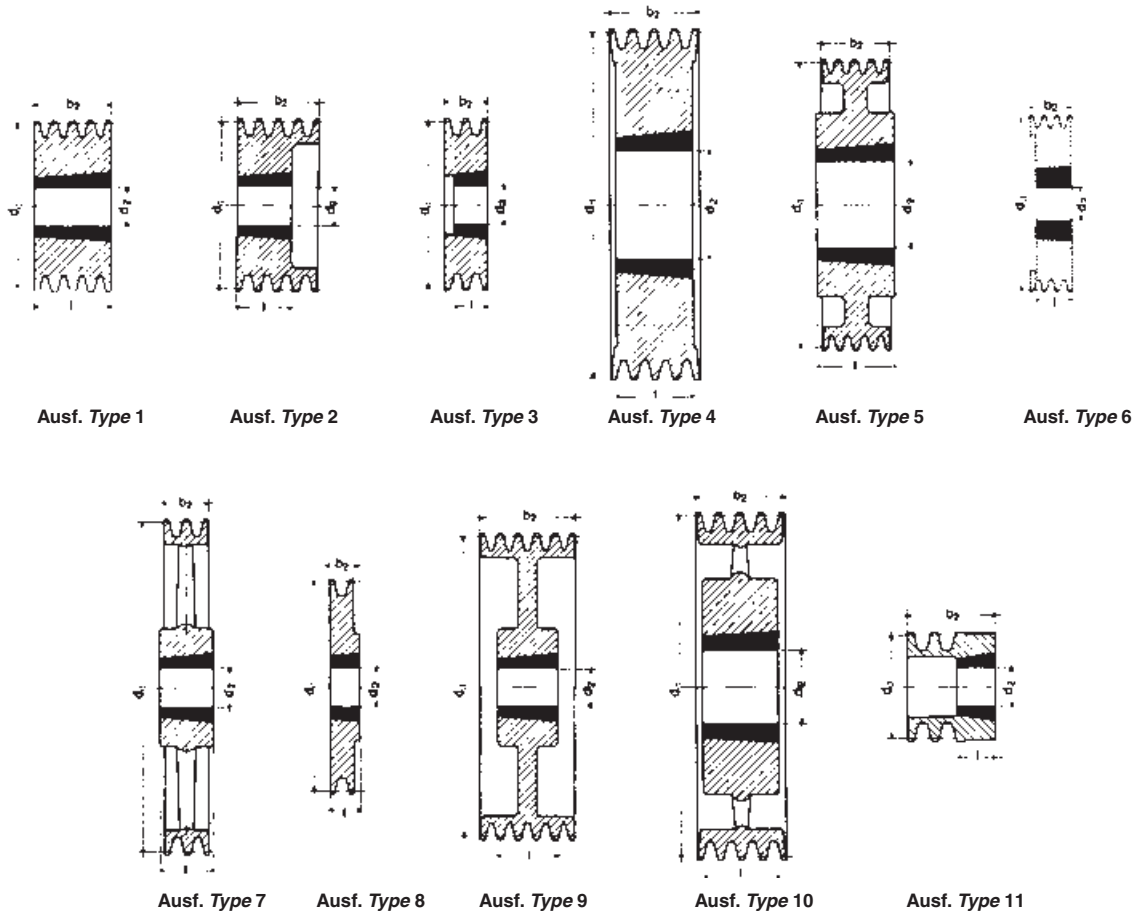

Fertigungstechnische Änderungen der Ausführungen vorbehalten.
 We reserve the right to make technical changes.

Auswuchten

Die Listenpreise gelten für in einer Ebene nach DIN/ISO 1940 ausgewuchtete GG-Scheiben wie folgt:
 Gütestufe G 6,3 für $\varnothing d_d \leq 400$ mm bei $n = 1500 \text{ min}^{-1}$, für $\varnothing d_d > 400$ mm bei $v = 30 \text{ m/s}$.

Die Auswuchtung wird ohne Nut auf glattem Wuchtdorn vorgenommen. Für Maschinen, deren Läufer mit einer in das Wellenende eingesetzten vollen Passfeder ausgewuchtet sind, muss mit folgendem Vermerk bestellt werden: »Ausgewuchtet mit Fertigbohrung und leerer Nut auf glattem Wuchtdorn ohne eingesetzte Passfeder«.

Ein Auswuchten in zwei Ebenen Gütestufe G 6,3 oder feiner ist erforderlich, wenn $v \geq 30 \text{ m/s}$ oder das Verhältnis Richtdurchmesser zu Kranzbreite $d_d : b_2 < 4$ ist bei $v > 20 \text{ m/s}$.

Mehrpreis auf Anfrage nach Bekanntgabe der Betriebsdrehzahl.

Balancing

The list prices apply, as per VDI 2060, to cast iron pulleys balanced in one plane as follows:
 Grade G 6.3 for $\varnothing d_d \leq 400$ mm at $n = 1500 \text{ rpm}$, for $\varnothing d_d > 400$ mm at $v = 30 \text{ m/sec}$.

Balancing is carried out minus the key on a smooth mandrel. Machines where the rotors are balanced with an adjusting spring inserted in the shaft end must be ordered as follows: "Balanced with finished bore without key on a smooth mandrel without inserted spring".

We recommend balancing in two planes grade G 6.3 or better if $v \geq 30 \text{ m/sec}$. or if the ratio between datum diameter and pulley face width $d_d : b_2 < 4$ at $v > 20 \text{ m/sec}$.

Surcharges for balancing on request. Please give pulley operating speed.

Aufschläge für Fertigbohrung H7 und Passfedernut nach DIN 6885 Teil 1
Surcharges for finished bore H7 and keyway to DIN 6885 part 1

Stück Quantity	Fertigbohrung bis 30 mm Finished bore up to 30 mm		Fertigbohrung 31 bis 50 mm Finished bore 31 to 50 mm		Fertigbohrung 51 bis 75 mm Finished bore 51 to 75 mm		Gewindebohrung für Stellschraube Drilled and tapped for setscrews
	ohne Nut without keyway	mit Nut with keyway	ohne Nut without keyway	mit Nut with keyway	ohne Nut without keyway	mit Nut with keyway	
1 bis to 2							
3 bis to 5							
6 bis to 10							
11 bis to 24							
25 bis to 50							
über over 50							

Sonderbearbeitungen und Sonderscheiben auf Anfrage. *Special pulleys and custom designed pulleys on request.*

Profil Section SPZ/10

Richt- durchmesser Datum diameter d _d (mm)	Anzahl der Rillen No. of grooves	Ausführung Type		Gewicht ohne Buchse Weight without bush (= kg)	Taper- Buchse Taper bush	Richt- durchmesser Datum diameter d _d (mm)	Anzahl der Rillen No. of grooves	Ausführung Type		Gewicht ohne Buchse Weight without bush (= kg)	Taper- Buchse Taper bush	
		●	11					●	8			
50▲	1	●	11	0,3	1008	118	1	●	8	0,9	1610	
	2	●	11	0,4	1008		2	●	6	1,3	1610	
56▲	1	●	11	0,4	1008		3	●	6	1,6	2012	
	2	●	11	0,5	1108		4	●	6	1,8	2012	
60	1	●	11	0,2	1008		5	●	6	1,8	2012	
	2	●	11	0,6	1108		6*	●	6	2,0	2517	
63	1	●	8	0,2	1108		125	1	●	8	1,0	1610
	2	●	6	0,3	1108			2	●	6	1,4	1610
	3	●	6	0,4	1108			3	●	2	1,8	2012
	67	1	●	8	0,3			1108	4	●	2	2,2
2		●	6	0,4	1108			5	●	6	2,3	2012
3		●	6	0,5	1108			6*	●	6	2,5	2517
71	1	●	8	0,3	1108	132		1	●	8	1,1	1610
	2	●	6	0,4	1108			2	●	6	1,5	1610
	3	●	6	0,6	1108			3	●	2	2,3	2012
	75	1	●	8	0,4			1108	4	●	2	2,5
2		●	6	0,4	1210			5	●	6	2,7	2517
3		●	6	0,5	1210			6*	●	6	2,9	2517
80	1	●	8	0,5	1210		140	1	●	8	1,2	1610
	2	●	6	0,6	1210			2	●	2	1,7	1610
	3	●	6	0,7	1210			3	●	2	2,6	2012
	4	●	6	0,8	1210			4	●	2	2,9	2012
	85	1	●	8	0,6			1210	5	●	2	3,2
2		●	6	0,5	1610			6*	●	2	3,5	2517
3		●	6	0,6	1610	8*		●	4	4,0	2517	
4		●	6	0,9	1610	150		1	●	8	1,2	1610
5		●	6	1,0	1610			2	●	8	2,0	2012
90	1	●	8	0,7	1210			3	●	2	3,1	2012
	2	●	6	0,7	1610			4	●	2	3,7	2517
	3	●	6	0,8	1610			5	●	2	4,0	2517
	4	●	6	1,0	1610		6*	●	2	4,4	2517	
	5	●	6	1,2	1610		8*	●	4	5,1	2517	
95	1	●	8	0,7	1210		160	1	●	8	1,3	1610
	2	●	6	0,8	1610			2	●	8	2,5	2012
	3	●	6	0,9	1610			3	●	2	3,6	2012
	4	●	6	1,1	1610			4	●	2	4,4	2517
	5	●	6	1,3	1610			5	●	2	4,8	2517
100	1	●	8	0,8	1210	6*		●	2	5,2	2517	
	2	●	6	0,9	1610	8*		●	4	5,6	2517	
	3	●	6	1,1	1610	170		1	●	8	1,5	1610
	4	●	6	1,1	1610			2	●	8	2,5	2012
	5	●	6	1,3	2012			3	○	9	4,2	2012
	6*	●	6	1,4	2012			4	●	2	5,3	2517
106	1	●	8	0,9	1610			5	●	2	5,9	2517
	2	●	6	1,1	1610		6*	●	2	6,5	2517	
	3	●	6	1,3	1610		180	1	●	8	1,6	1610
	4	●	6	1,3	1610			2	●	8	2,5	2012
	5	●	6	1,5	2012			3	○	9	4,8	2012
	6*	●	6	1,6	2012			4	○	9	6,1	2517
112	1	●	8	1,0	1610			5	○	9	6,3	2517
	2	●	6	1,3	1610			6*	○	9	6,8	2517
	3	●	6	1,3	2012	8*		●	4	7,1	3020	
	4	●	6	1,5	2012	190		1	●	8	1,8	1610
	5	●	6	1,8	2012			2	●	8	2,6	2012
	6*	●	6	1,9	2012			3	○	9	4,9	2012
					4			○	9	5,3	2517	
					5			○	9	6,3	2517	
					6*		○	9	6,9	2517		

▲ nur für Profil 10 only for section 10

Anzahl der Rillen No. of grooves z	1	2	3	4	5	6	8
Kranzbreite Face width b ₂ (mm)	16	28	40	52	64	76	100

Taper-Buchse Taper bush	1008	1108	1210	1610	2012	2517	3020
Bohrung d ₂ (mm) von ... bis ... Bore d ₂ (mm) from ... to ...	10-25	10-28	11-32	14-42	14-50	16-60	25-75

- Vollscheibe Solid pulley
 - Bodenscheibe Plate pulley
(mit oder ohne Spiegel with or without holes)
 - × Armscheibe Spoked pulley
- Material: EN-GJL 200 – DIN EN 1561
 * Keine Lagerware Non stock items

Bohrungsdurchmesser d₂ siehe Seite 89.
 Bore diameters d₂ see page 89.

Profil Section SPZ/10

Richt- durchmesser Datum diameter d _d (mm)	Anzahl der Rillen No. of grooves	Ausführung Type		Gewicht ohne Buchse Weight without bush (= kg)	Taper- Buchse Taper bush	Richt- durchmesser Datum diameter d _d (mm)	Anzahl der Rillen No. of grooves	Ausführung Type		Gewicht ohne Buchse Weight without bush (= kg)	Taper- Buchse Taper bush	
		●	○					x				
200	1	●	8	2,3	2012	500	2	x	7	9,1	2517	
	2	●	8	2,8	2012		3	x	7	11,4	2517	
	3	○	9	3,5	2012		4	x	10	14,3	3020	
	4	○	9	4,7	2517		5	x	10	17,6	3020	
	5	○	9	5,5	2517		6*	x	10	19,9	3020	
	6*	○	9	6,1	2517		630	3*	x	7	15,9	2517
	8*	●	4	9,3	3020			4*	x	10	20,0	3020
								5*	x	10	22,7	3020
224	1	○	5	2,5	2012		6*	x	7	33,6	3535	
	2	○	5	3,2	2012							
	3	○	9	3,9	2012							
	4	○	9	5,2	2517							
	5	○	9	6,0	2517							
	6*	○	9	6,6	2517							
	8*	●	4	11,8	3020							
250	1	x	7	2,8	2012							
	2	x	7	3,5	2012							
	3	x	10	4,3	2012							
	4	x	10	5,7	2517							
	5	x	10	6,4	2517							
	6*	x	10	7,0	2517							
	8*	x	10	10,5	3020							
280	1	x	7	2,9	2012							
	2	x	7	4,0	2012							
	3	x	7	5,3	2517							
	4	x	10	6,4	2517							
	5	x	10	7,1	2517							
	6*	x	10	7,8	2517							
	8*	x	10	10,8	3020							
315	1	x	7	3,1	2012							
	2	x	7	4,2	2012							
	3	x	7	6,1	2517							
	4	x	10	7,6	2517							
	5	x	10	8,6	2517							
	6*	x	10	9,3	2517							
355	1	x	7	3,5	2012							
	2	x	7	5,1	2012							
	3	x	7	7,3	2517							
	4	x	10	8,9	2517							
	5	x	10	10,0	2517							
	6*	x	10	10,7	2517							
	8*	x	10	16,0	3030							
400	1	x	7	6,0	2012							
	2	x	7	6,3	2517							
	3	x	7	8,0	2517							
	4	x	10	10,1	2517							
	5	x	10	11,7	3020							
	6*	x	10	14,5	3020							
	8*	x	10	18,2	3030							
450	1	x	7	6,1	2517							
	2	x	7	8,2	2517							
	3	x	7	9,8	2517							
	4	x	10	11,8	3020							
	5	x	10	13,9	3020							
	6*	x	10	16,9	3030							
	8*	x	10	24,0	3535							

Anzahl der Rillen No. of grooves z	1	2	3	4	5	6	8
Kranzbreite Face width b ₂ (mm)	16	28	40	52	64	76	100

Taper-Buchse Taper bush	2012	2517	3020	3030	3535
Bohrung d ₂ (mm) von ... bis ... Bore d ₂ (mm) from ... to ...	14-50	16-60	25-75	35-75	35-90

- Vollscheibe *Solid pulley*
 - Bodenscheibe *Plate pulley*
(mit oder ohne Spiegel *with or without holes*)
 - × Armscheibe *Spoked pulley*
- Material: EN-GJL 200 – DIN EN 1561
 * Keine Lagerware *Non stock items*

Bohrungsdurchmesser d₂ siehe Seite 89.
 Bore diameters d₂ see page 89.

Profil Section SPA/13

Richt- durchmesser Datum diameter d _d (mm)	Anzahl der Rillen No. of grooves	Ausführung Type		Gewicht ohne Buchse Weight without bush (= kg)	Taper- Buchse Taper bush	Richt- durchmesser Datum diameter d _d (mm)	Anzahl der Rillen No. of grooves	Ausführung Type		Gewicht ohne Buchse Weight without bush (= kg)	Taper- Buchse Taper bush	
		●	11					○	8			
63▲	1	●	11	0,6	1108	140	1	●	8	1,8	1610	
	2	●	11	0,8	1108		2	○	2	2,0	2012	
67▲	1	●	8	0,3	1108		3	●	2	2,8	2517	
	2	●	6	0,5	1108		4	●	2	3,1	2517	
71▲	1	●	8	0,3	1108	150	5	●	2	3,4	2517	
	2	●	6	0,5	1108		1	●	8	1,4	1610	
	3	●	6	0,7	1108		2	●	2	2,4	2012	
75▲	1	●	8	0,4	1108		3	●	2	3,5	2517	
	2	●	6	0,6	1108		4	●	2	3,8	2517	
	3	●	6	0,8	1108		5	●	2	4,2	2517	
80▲	1	●	8	0,5	1210	160	1	○	5	1,9	1610	
	2	●	6	0,6	1210		2	●	2	2,9	2012	
	3	●	6	0,9	1210		3	●	2	3,9	2517	
85	1	●	8	0,6	1210		4	●	2	4,4	2517	
	2	●	6	0,7	1210		5	●	2	5,1	2517	
	3	●	6	1,0	1210		170	1	○	5	2,0	1610
90	1	●	8	0,7	1210	2		●	2	3,1	2012	
	2	●	6	0,7	1610	3		●	2	4,6	2517	
	3	●	6	1,0	1610	4	●	2	5,5	2517		
95	1	●	8	0,8	1210		5	●	2	5,9	3020	
	2	●	6	0,9	1610		180	1	○	5	2,1	1610
	3	●	6	1,1	1610			2	○	9	3,4	2012
4	●	6	1,4	1615	3	●		2	5,1	2517		
100	1	●	8	0,8	1610	190	4	●	2	5,9	2517	
	2	●	6	0,9	1610		5	●	2	6,2	3020	
	3	●	2	1,2	1610		200	1	○	5	2,6	2012
	4	●	2	1,7	1610			2	○	5	4,1	2517
	5	●	6	1,9	1610			3	○	9	4,9	2517
106	1	●	8	0,9	1610		4	●	2	7,4	3020	
	2	●	6	1,1	1610		5	●	4	8,4	3020	
	3	●	2	1,4	1610		212	1	○	5	2,7	2012
	4	●	6	2,0	2012			2	○	5	4,3	2517
	5	●	6	2,0	2012			3	○	9	5,2	2517
112	1	●	8	1,0	1610	224	4	●	2	7,3	3020	
	2	●	6	1,2	1610		5	●	2	8,2	3020	
	3	●	6	1,3	2012		236	1	x	7	2,7	2012
	4	●	6	1,9	2012			2	○	5	4,4	2517
	5	●	6	2,1	2012			3	○	9	5,5	2517
118	1	●	8	1,2	1610		4	●	2	7,4	3020	
	2	●	6	1,4	1610		5	●	2	8,3	3020	
	3	●	2	1,8	2012		250	1	x	7	2,9	2012
	4	●	2	2,0	2012			2	x	7	4,8	2517
	5	●	2	2,4	2012			3	○	9	5,9	2517
125	1	●	8	1,4	1610	236	4	○	9	8,0	3020	
	2	●	2	1,7	1610		5	○	9	9,0	3020	
	3	●	2	2,0	2012		250	1	x	7	2,9	2012
	4	●	2	2,5	2012			2	x	7	4,8	2517
	5	●	2	2,7	2012			3	○	9	5,9	2517
132	1	●	8	1,6	1610	250	4	○	9	8,0	3020	
	2	●	2	1,8	2012		5	○	9	9,0	3020	
	3	●	2	2,3	2012		250	1	x	7	2,9	2012
	4	●	2	2,6	2517			2	x	7	4,8	2517
	5	●	2	2,9	2517			3	○	9	5,9	2517

▲ nur für Profil 13 only for section 13

Anzahl der Rillen No. of grooves z	1	2	3	4	5
Kranzbreite Face width b ₂ (mm)	20	35	50	65	80

Taper-Buchse Taper bush	1108	1210	1610	1615	2012	2517	3020	3535
Bohrung d ₂ (mm) von ... bis ... Bore d ₂ (mm) from ... to ...	10-28	11-32	14-42	14-42	14-50	16-60	25-75	35-90

- Vollscheibe Solid pulley
 - Bodenscheibe Plate pulley
(mit oder ohne Spiegel with or without holes)
 - × Armscheibe Spoked pulley
- Material: EN-GJL 200 – DIN EN 1561

Bohrungsdurchmesser d₂ siehe Seite 89.
 Bore diameters d₂ see page 89.

Profil Section SPA/13

Richt- durchmesser Datum diameter d _d (mm)	Anzahl der Rillen No. of grooves	Ausführung Type		Gewicht ohne Buchse Weight without bush (= kg)	Taper- Buchse Taper bush	Richt- durchmesser Datum diameter d _d (mm)	Anzahl der Rillen No. of grooves	Ausführung Type		Gewicht ohne Buchse Weight without bush (= kg)	Taper- Buchse Taper bush	
280	1	x	7	3,3	2012	450	1	x	7	7,0	2012	
	2	x	7	5,4	2517			2	x	7	10,3	2517
	3	O	9	6,7	2517			3	x	7	14,1	3020
	4	O	9	8,8	3020			4	x	10	15,5	3020
	5	O	5	15,5	3535			5	x	7	24,3	3535
315	1	x	7	3,6	2012	500	1	x	7	8,0	2517	
	2	x	7	6,0	2517			2	x	7	11,6	2517
	3	O	5	8,3	3020			3	x	7	16,0	3020
	4	O	9	9,7	3020			4	x	10	18,2	3020
	5	O	5	17,0	3535			5	x	7	27,3	3535
355	1	x	7	4,2	2012	560	1	x	7	11,6	2517	
	2	x	7	6,7	2517			2	x	7	15,5	3020
	3	x	7	9,2	3020			3	x	7	17,8	3020
	4	x	10	11,0	3020			4	x	7	26,7	3535
	5	x	7	18,6	3535			5	x	7	30,4	3535
400	1	x	7	4,9	2012	630	1	x	7	10,1	2517	
	2	x	7	8,1	2517			2	x	7	16,0	3020
	3	x	7	11,0	3020			3	x	7	22,0	3020
	4	x	10	12,8	3020			4	x	7	30,8	3535
	5	x	7	21,0	3535			5	x	7	33,7	3535

Anzahl der Rillen No. of grooves z	1	2	3	4	5
Kranzbreite Face width b ₂ (mm)	20	35	50	65	80

Taper-Buchse Taper bush	2012	2517	3020	3535
Bohrung d ₂ (mm) von ... bis ... Bore d ₂ (mm) from ... to ...	14-50	16-60	25-75	35-90

- Vollscheibe *Solid pulley*
 - Bodenscheibe *Plate pulley*
(mit oder ohne Spiegel *with or without holes*)
 - × Armscheibe *Spoked pulley*
- Material: EN-GJL 200 – DIN EN 1561

Bohrungsdurchmesser d₂ siehe Seite 89.
 Bore diameters d₂ see page 89.

Profil Section SPB/17

Richt- durchmesser Datum diameter d _d (mm)	Anzahl der Rillen No. of grooves	Ausführung Type		Gewicht ohne Buchse Weight without bush (= kg)	Taper- Buchse Taper bush	Richt- durchmesser Datum diameter d _d (mm)	Anzahl der Rillen No. of grooves	Ausführung Type		Gewicht ohne Buchse Weight without bush (= kg)	Taper- Buchse Taper bush		
		●	1					●	8				
100▲	1	●	1	0,9	1610	200	1	●	8	5,0	2012		
	2	●	6	1,2	1610		2	●	8	5,4	2517		
	3	●	6	1,7	1610		3	●	2	6,5	2517		
112▲	1	●	1	1,1	1610		4	●	2	8,8	3020		
	2	●	6	1,5	1610		5	●	2	9,1	3020		
	3	●	6	2,0	1610		6	●	4	10,3	3020		
118▲	1	●	1	1,3	1610		8	●	4	13,5	3535		
	2	●	6	1,7	1610		212	1	●	8	4,2	2012	
	3	●	6	2,3	1610			2	●	8	4,9	2517	
125▲	1	●	1	1,5	1610			3	●	2	6,0	2517	
	2	●	2	1,9	2012			4	●	2	9,8	3020	
	3	●	2	2,4	2012			5	●	2	11,0	3020	
132▲	4	●	4	3,0	2012	6		●	4	14,3	3535		
	5	●	6	3,5	2012	8		●	4	16,6	3535		
	140	1	●	1	1,8	1610		224	1	●	8	4,7	2012
		2	●	2	2,2	2012			2	●	8	5,3	2517
		3	●	2	2,8	2012			3	●	2	6,3	2517
4		●	4	3,4	2012	4			●	2	11,3	3020	
5		●	4	3,7	2012	5			●	2	12,7	3020	
150	1	●	1	2,3	1610	6	●		4	17,0	3535		
	2	●	2	2,7	2012	8	●		4	19,3	3535		
	3	●	2	3,3	2012	10	●		4	21,8	3535		
	4	●	2	3,7	2517	236	1		●	8	5,0	2012	
	5	●	2	4,5	2517		2		●	8	5,5	2517	
	6	●	4	4,6	2517		3		x	10	7,0	2517	
160	1	●	1	2,5	1610		4		x	10	14,5	3020	
	2	●	2	2,9	2012		5	●	6	16,9	3535		
	3	●	2	4,2	2517		6	●	4	20,0	3535		
	4	●	4	4,9	2517	8	●	4	22,3	3535			
	5	●	4	6,0	2517	10	●	4	25,3	3535			
	6	●	4	5,4	3020	250	1	●	8	5,4	2012		
170	1	●	1	2,9	1610		2	x	7	5,5	2517		
	2	●	2	3,3	2012		3	●	2	7,7	3020		
	3	●	2	4,9	2517		4	●	2	19,6	3020		
	4	●	4	5,7	2517		5	●	4	21,7	3535		
	5	●	4	6,1	3020		6	●	4	23,3	3535		
	6	●	4	6,5	3020	8	●	4	27,5	3535			
180	7	●	4	7,7	3020	10	●	4	29,3	3535			
	8	●	4	9,5	3020	265	2	●	7	6,2	2517		
	190	1	●	8	4,6		2012	3	O	9	8,0	3020	
		2	●	8	5,0		2517	4	O	9	9,5	3020	
		3	●	2	6,3		2517	6	O	9	16,7	3525	
		4	●	4	7,6		2517	8	O	9	24,0	3525	
		5	●	4	8,1		3020	280	1	x	7	6,1	2012
		6	●	4	9,2	3020	2		x	7	6,8	2517	
8	●	4	11,2	3030	3	x	10		8,6	3020			
200	1	●	1	1,1	1610	4	O		9	10,1	3020		
	2	●	6	1,5	1610	5	O		9	17,8	3535		
	3	●	6	2,0	1610	6	O		9	19,6	3535		
	210	1	●	1	1,3	1610	8	O	9	26,7	3535		
		2	●	6	1,7	1610	10	O	9	30,5	3535		
		3	●	6	2,3	1610	300	2	x	7	7,3	2517	
4		●	2	2,4	2012	3		x	10	9,2	3020		
5		●	2	2,4	2012	4		O	9	14,3	3020		
6		●	4	3,0	2012	5		O	9	18,2	3535		
8	●	4	3,5	2012	6	O		9	21,9	3535			
						8		O	9	26,2	3535		

▲ nur für Profil 17 only for section 17

Anzahl der Rillen No. of grooves z	1	2	3	4	5	6	8	10
Kranzbreite Face width b ₂ (mm)	25	44	63	82	101	120	158	196

Taper-Buchse Taper bush	1610	2012	2517	3020	3030	3535
Bohrung d ₂ (mm) von ... bis ... Bore d ₂ (mm) from ... to ...	14-42	14-50	16-60	25-75	35-75	35-90

- Vollscheibe Solid pulley
 - O Bodenscheibe Plate pulley
(mit oder ohne Spiegel with or without holes)
 - x Armscheibe Spoked pulley
- Material: EN-GJL 200 – DIN EN 1561

Bohrungsdurchmesser d₂ siehe Seite 89.
 Bore diameters d₂ see page 89.

Profil Section SPB/17

Richt- durchmesser Datum diameter d _d (mm)	Anzahl der Rillen No. of grooves	Ausführung Type		Gewicht ohne Buchse Weight without bush (= kg)	Taper- Buchse Taper bush	Richt- durchmesser Datum diameter d _d (mm)	Anzahl der Rillen No. of grooves	Ausführung Type		Gewicht ohne Buchse Weight without bush (= kg)	Taper- Buchse Taper bush		
315	1	x	7	7,2	2012	560	2	x	7	16,5	3030		
	2	x	7	7,8	2517		3	x	7	25,9	3235		
	3	x	10	9,6	3020		4	x	7	29,0	3535		
	4	O	5	17,1	3535		5	x	7	35,3	4040		
	5	O	9	18,8	3535		6	x	10	43,1	4040		
	6	O	9	23,0	3535		8	x	10	49,0	4545		
	8	O	9	26,0	3535		10*	x	10	55,7	4545		
	10	O	9	31,5	3535		630	2	x	7	18,5	3020	
	335	2	x	7	7,8			2517	3	x	7	28,9	3535
		3	x	10	10,5			3020	4	x	7	33,3	3535
4		x	7	18,3	3535	5		x	7	43,1	4040		
5		x	10	19,5	3535	6		x	10	49,2	4040		
6		x	10	22,0	3535	8		x	10	62,0	4545		
8		x	10	28,2	3535	10*		x	10	72,0	4545		
10*		x	10	36,0	4040	710		3	x	7	33,2	3535	
355		2	x	7	8,7			3020	4	x	7	39,1	3535
		3	x	10	10,8			3020	5	x	7	50,2	4040
		4	x	7	18,6		3535	6	x	10	62,3	4545	
	5	x	10	20,8	3535		8	x	10	71,0	4545		
	6	O	9	22,8	3535		10*	x	10	80,0	4545		
	8	x	10	27,0	3535		800	3	x	7	36,7	3535	
	10*	x	10	38,0	4040			4	x	7	48,8	4040	
	375	2	x	7	9,5			3020	5	x	7	56,1	4040
		3	x	10	11,5			3020	6	x	10	71,4	4545
		4	x	10	16,5	3525		8	x	10	90,9	4545	
6		x	10	25,0	3535	10*		x	10	102,0	4545		
8		x	10	28,0	4040	900		3	x	7	46,8	3535	
400		2	x	7	10,0			3020	4	x	7	60,0	4040
		3	x	7	18,3			3535	5	x	7	74,8	4545
		4	x	7	20,5			3535	6	x	10	81,5	4545
		5	x	10	23,4		3535	8	x	10	110,0	4545	
		6	x	10	25,1		3535	10*	x	10	126,0	5050	
	8	x	10	36,5	4040		1000	3	x	7	56,5	4040	
	10*	x	10	41,0	4040			4	x	7	66,5	4040	
	425	2	x	7	11,5			3020	5	x	7	80,5	4545
		3	x	7	18,0			3535	6	x	10	90,0	4545
		4	x	7	19,5	3535		8	x	10	132,0	5050	
6		x	10	25,1	4040	10*		x	10	147,0	5050		
8		x	10	52,5	4545	450		2	x	7	12,1	3020	
450		3	x	7	21,9			3535	3	x	7	24,5	3535
		4	x	7	24,5			3535	5	x	10	27,3	3535
		5	x	10	27,3			3535	6	x	10	35,5	4040
		6	x	10	35,5		4040	8	x	10	40,9	4040	
		8	x	10	40,9		4040	10*	x	10	53,5	4545	
	10*	x	10	53,5	4545		500	2	x	7	13,2	3020	
	500	3	x	7	23,1			3535	3	x	7	26,6	3535
		4	x	7	26,6			3535	5	x	10	29,9	3535
		5	x	10	29,9			3535	6	x	10	38,9	4040
		6	x	10	38,9	4040		8	x	10	45,5	4040	
8		x	10	45,5	4040	10*		x	10	61,0	4545		
10*		x	10	61,0	4545								

Anzahl der Rillen No. of grooves z	1	2	3	4	5	6	8	10
Kranzbreite Face width b ₂ (mm)	25	44	63	82	101	120	158	196

Taper-Buchse Taper bush	2012	2517	3020	3030	3535	4040	4545	5050
Bohrung d ₂ (mm) von ... bis ... Bore d ₂ (mm) from ... to ...	14-50	16-60	25-75	35-75	35-90	40-100	55-110	70-125

- Vollscheibe Solid pulley
 - O Bodenscheibe Plate pulley
(mit oder ohne Spiegel with or without holes)
 - × Armscheibe Spoked pulley
- Material: EN-GJL 200 – DIN EN 1561
 * Keine Lagerware Non stock items

Bohrungsdurchmesser d₂ siehe Seite 89.
 Bore diameters d₂ see page 89.

Profil Section SPC/22

Richt- durchmesser Datum diameter d _d (mm)	Anzahl der Rillen No. of grooves	Ausführung Type		Gewicht ohne Buchse Weight without bush (= kg)	Taper- Buchse Taper bush	Richt- durchmesser Datum diameter d _d (mm)	Anzahl der Rillen No. of grooves	Ausführung Type		Gewicht ohne Buchse Weight without bush (= kg)	Taper- Buchse Taper bush	
		●	4					○	5			
200▲	3	●	4	9,0	2517	355	3	○	5	22,9	3535	
	4	●	4	10,5	3020		4	○	9	28,3	3535	
	5	●	4	14,0	3535		5	○	9	32,5	3535	
	6	●	4	17,0	3535		6	○	9	36,0	3535	
212▲	3	●	4	10,0	3020		8	○	9	67,5	4040	
	4	●	4	12,5	3020		10*	○	9	121,0	4545	
	5	●	4	15,0	3535		375	3	○	5	23,8	3535
	6	●	4	18,0	3535			4	○	9	30,0	3535
224	2	●	4	8,1	3020			5	○	9	33,0	3535
	3	●	4	11,0	3020			6	○	9	45,5	4040
	4	●	4	14,0	3535			8	○	9	68,0	4545
	5	●	4	16,2	3535			400	3	x	7	24,1
6	●	4	19,0	3535	4	x			10	28,0	3535	
8	●	4	24,9	3535	5	x			10	34,0	3535	
236	3	●	4	12,0	3020	6			○	9	48,0	4040
	4	●	4	17,2	3535	8			○	9	65,0	4545
	5	●	4	19,1	3535	10*			○	9	88,0	5050
	6	●	4	20,8	3535	425			3	x	7	26,0
8	●	4	25,5	3535	4		x		10	31,0	3535	
250	2	●	4	9,8	3020		5		○	9	45,0	4040
	3	●	4	14,5	3020		6		○	9	58,0	4545
	4	●	4	20,7	3535		8		○	9	74,0	4545
	5	●	4	22,8	3535		450		3	x	7	28,6
6	●	4	26,0	3535	4			x	10	33,5	3535	
8	●	4	29,7	3535	5			x	10	45,0	4040	
10*	●	4	34,0	4040	6			○	9	61,1	4545	
265	3	●	8	21,2	3535			8	○	9	78,7	5050
	4	○	9	24,0	3535			10*	○	9	101,0	5050
	5	○	9	26,2	3535			475	3	x	7	40,0
	6	○	9	29,0	3535	4			x	10	47,0	3535
8	○	9	33,3	3535	5	x			10	47,2	4040	
280	3	●	8	24,0	3535	6			○	9	62,8	4545
	4	○	9	29,0	3535	8			○	9	81,5	5050
	5	○	9	31,0	3535	500			3	x	7	30,9
	6	○	9	33,8	3535		4		x	10	39,0	3535
8	○	9	37,5	3535	5		x		10	48,7	4040	
10*	○	9	45,0	4040	6		x		10	60,2	4545	
300	3	○	5	21,0	3535		8		○	9	87,4	5050
	4	○	9	25,0	3535		10*		○	9	127,0	5050
	5	○	9	28,5	3535		560		3	x	7	36,0
	6	○	9	29,0	3535			4	x	10	50,0	4040
8	●	4	46,5	4040	5			x	10	63,0	4545	
10*	○	9	53,5	4545	6			x	10	77,0	5050	
315	3	○	5	21,6	3535			8	x	10	94,0	5050
	4	○	9	24,6	3535			10*	○	9	115,0	5050
	5	○	9	29,0	3535	630		3	x	7	48,5	4040
	6	○	9	31,4	3535			4	x	7	61,0	4545
8	●	4	50,0	4040	5			x	10	77,0	5050	
10*	○	9	58,0	4545	6			x	10	86,0	5050	
335	3	○	5	22,5	3535			8	x	10	105,5	5050
	4	○	9	26,5	3535			10*	○	9	130,0	5050
	5	○	9	30,0	3535		710	3	x	7	62,5	4040
	6	○	9	35,0	3535			4	x	7	78,6	4545
8	○	9	58,0	4040	5			x	10	89,6	5050	
					6			x	10	99,4	5050	
					8			x	10	117,5	5050	
					10*			○	9	137,1	5050	

▲ nur für Profil 22 only for section 22

Anzahl der Rillen No. of grooves z	2	3	4	5	6	8	10
Kranzbreite Face width b ₂ (mm)	59,5	85	110,5	136	161,5	212,5	263,5

Taper-Buchse Taper bush	2517	3020	3535	4040	4545	5050
Bohrung d ₂ (mm) von ... bis ... Bore d ₂ (mm) from ... to ...	16-60	25-75	35-90	40-100	55-110	70-125

- Vollscheibe Solid pulley
 - Bodenscheibe Plate pulley (mit oder ohne Spiegel with or without holes)
 - × Armscheibe Spoked pulley
- Material: EN-GJL 200 – DIN EN 1561
 * Keine Lagerware Non stock items

Bohrungsdurchmesser d₂ siehe Seite 89.
 Bore diameters d₂ see page 89.

Profil Section SPC/22											
Richt- durchmesser Datum diameter d _d (mm)	Anzahl der Rillen No. of grooves	Ausführung Type		Gewicht ohne Buchse Weight without bush (= kg)	Taper- Buchse Taper bush	Richt- durchmesser Datum diameter d _d (mm)	Anzahl der Rillen No. of grooves	Ausführung Type		Gewicht ohne Buchse Weight without bush (= kg)	Taper- Buchse Taper bush
		x	7					x	10		
800	3	x	7	72,0	4545	1250	5	x	10	177,6	5050
	4	x	7	90,8	5050		6	x	10	201,4	5050
	5	x	10	102,5	5050		8	x	10	243,7	5050
	6	x	10	113,7	5050		10*	O	9	292,1	5050
	8	x	10	136,6	5050						
	10*	O	9	160,7	5050						
1000	5	x	10	134,0	5050						
	6	x	10	150,0	5050						
	8	x	10	181,4	5050						
	10*	O	9	217,2	5050						

Anzahl der Rillen No. of grooves z	3	4	5	6	8	10
Kranzbreite Face width b ₂ (mm)	85	110,5	136	161,5	212,5	263,5

Taper-Buchse Taper bush	4545	5050
Bohrung d ₂ (mm) von ... bis ... Bore d ₂ (mm) from ... to ...	55-110	70-125

- Vollscheibe *Solid pulley*
 - Bodenscheibe *Plate pulley*
(mit oder ohne Spiegel *with or without holes*)
 - × Armscheibe *Spoked pulley*
- Material: EN-GJL 200 – DIN EN 1561
 * Keine Lagerware *Non stock items*

Bohrungsdurchmesser d₂ siehe Seite 89.
 Bore diameters d₂ see page 89.

Profil Section SPZ/10

Richt- durchmesser Datum diameter d _d (mm)	Anzahl der Rillen No. of grooves	Aus- führung Type	Gewicht Weight (≈ kg)	Fertig- bohrung Finished bore d _{max} (mm)	Naben- länge Hub length l (mm)	Richt- durchmesser Datum diameter d _d (mm)	Anzahl der Rillen No. of grooves	Aus- führung Type	Gewicht Weight (≈ kg)	Fertig- bohrung Finished bore d _{max} (mm)	Naben- länge Hub length l (mm)
45▲	1	○	0,2	16	24	170	1	x	1,7	40	30
	2	○	0,3	16	35		2	x	1,9	40	38
	3	○	0,4	16	35		3	x	3,0	42	40
50▲	1	○	0,3	20	24	180	1	x	2,1	32	30
	2	○	0,4	20	35		2	x	3,1	38	38
	3	○	0,5	20	40		3	x	3,5	42	40
56▲	1	○	0,3	20	24	190	1	x	2,3	35	30
	2	○	0,5	25	35		2	x	2,4	35	38
	3	○	0,7	25	40		3	x	4,0	35	40
63	1	○	0,3	25	24	200	1	x	2,4	32	38
	2	○	0,6	25	35		2	x	2,9	38	38
	3	○	0,9	25	40		3	x	4,5	42	40
71	1	○	0,3	25	24	212	1	x	2,6	35	30
	2	○	0,6	25	35		2	x	3,4	35	38
	3	○	1,0	30	40		3	x	5,0	38	40
75	1	○	0,4	24	24	225	1	x	2,8	32	38
	2	○	0,6	24	35		2	x	4,0	38	38
	3	○	1,1	28	40		3	x	5,3	42	40
80	1	○	0,4	25	24	250	1	x	3,3	32	38
	2	○	0,7	30	35		2	x	4,8	38	38
	3	○	1,1	38	35		3	x	6,0	42	40
85	1	○	0,3	25	24	280	1	x	3,9	35	34
	2	○	0,7	30	35		2	x	5,2	42	38
	3	○	1,1	38	35		3	x	7,0	48	40
90	1	○	0,4	25	24	315	1	x	4,4	35	34
	2	○	0,8	30	35		2	x	6,8	42	38
	3	○	1,2	38	38		3	x	8,3	48	40
95	1	○	0,4	28	24	355	1	x	4,6	35	34
	2	○	0,8	28	35		2	x	8,0	42	40
	3	○	1,2	38	38		3	x	10,0	48	45
100	1	○	0,5	28	24						
	2	○	0,9	30	35						
	3	○	1,3	38	38						
106	1	○	0,5	30	24						
	2	○	1,0	28	35						
	3	○	1,3	38	38						
112	1	○	0,5	28	24						
	2	○	1,0	30	35						
	3	○	1,4	38	38						
118	1	○	0,6	28	24						
	2	○	1,1	38	35						
	3	○	1,5	38	38						
125	1	○	0,7	28	24						
	2	○	1,2	38	35						
	3	○	1,6	38	40						
132	1	○	0,8	30	24						
	2	○	1,3	38	35						
	3	○	1,6	40	40						
140	1	○	0,9	28	24						
	2	○	1,4	38	38						
	3	○	1,7	38	40						
150	1	x	1,1	28	24						
	2	○	1,5	38	38						
	3	○	1,9	38	40						
160	1	x	1,2	32	30						
	2	x	1,6	38	38						
	3	x	2,4	42	40						
▲ nur für Profil 10 only for section 10											

Anzahl der Rillen No. of grooves z	1	2	3
Kranzbreite Face width b ₂ (mm)	16	28	40

- Vollscheibe Solid pulley
 - Bodenscheibe Plate pulley (mit oder ohne Spiegel with or without holes)
 - × Armscheibe Spoked pulley
- Nabenlage: einseitig bündig Hub position: one side flush
 Material: EN-GJL 200 – DIN EN 1561

Profil Section SPA/13

Richt-durchmesser Datum diameter d_d (mm)	Anzahl der Rillen No. of grooves	Ausführung Type	Gewicht Weight (\approx kg)	Fertigbohrung Finished bore d_{max} (mm)	Nabenhöhe Hub length l (mm)	Richt-durchmesser Datum diameter d_d (mm)	Anzahl der Rillen No. of grooves	Ausführung Type	Gewicht Weight (\approx kg)	Fertigbohrung Finished bore d_{max} (mm)	Nabenhöhe Hub length l (mm)
50▲	1	O	0,3	18	34	125	1	O	1,4	32	34
	2	O	0,5	18	49		2	O	1,9	38	49
	3	O	0,6	18	47		3	O	2,6	42	42
56▲	1	O	0,4	20	34	132	4∇	O	3,5	42	53
	2	O	0,6	20	49		5∇	O	4,4	48	65
	3	O	0,7	20	47		140	1	O	1,5	32
63▲	1	O	0,5	25	34	2		O	2,2	38	49
	2	O	0,8	25	49	3		O	2,6	42	42
	3	O	0,9	25	47	4∇		O	3,6	42	53
	4∇	O	1,2	25	60	5∇		O	4,8	48	65
71▲	5∇	O	1,5	25	70	140	1	O	1,5	32	34
	1	O	0,5	25	34		2	O	2,3	38	49
	2	O	0,9	28	49		3	O	2,6	42	42
	3	O	1,0	32	42		4∇	O	3,7	42	53
	4∇	O	1,5	32	60		5∇	O	5,0	48	65
75▲	5∇	O	1,8	32	70	150	1	x	1,6	38	36
	1	O	0,5	24	34		2	x	2,6	38	49
	2	O	1,0	24	49		3	O	3,0	42	42
	3	O	1,1	24	42		4∇	O	4,0	42	53
	4∇	O	1,8	24	60		5∇	O	5,2	48	65
80▲	5∇	O	1,9	28	82	160	1	x	1,8	38	36
	1	O	0,6	28	34		2	x	2,4	38	49
	2	O	1,0	32	49		3	x	2,8	42	42
	3	O	1,2	38	42		4∇	O	3,6	48	60
	4∇	O	1,9	38	60		5∇	O	5,5	48	70
85	5∇	O	2,0	38	55	170	1	x	2,0	35	36
	1	O	0,6	24	34		2	x	2,9	35	49
	2	O	1,2	28	49		3	x	3,2	35	42
	3	O	1,4	28	42		4∇	x	4,2	35	60
	4∇	O	2,0	28	53		5∇	x	5,8	38	70
90	5∇	O	2,2	32	55	180	1	x	2,0	38	36
	1	O	0,9	28	34		2	x	3,2	42	49
	2	O	1,5	32	49		3	x	3,6	42	42
	3	O	1,6	38	42		4∇	x	4,7	48	60
	4∇	O	2,2	42	53		5∇	x	6,1	48	70
95	5∇	O	2,5	42	67	190	1	x	2,0	38	36
	1	O	0,8	28	34		2	x	3,2	42	49
	2	O	1,6	28	49		3	x	4,0	42	42
	3	O	1,9	28	42		4∇	x	5,2	48	60
	4∇	O	2,5	32	53		5∇	x	6,3	48	70
100	5∇	O	2,8	35	67	200	1	x	2,4	38	36
	1	O	0,8	28	34		2	x	2,9	42	49
	2	O	1,4	32	49		3	x	4,2	48	42
	3	O	2,0	38	42		4∇	x	5,0	55	60
	4∇	O	2,7	42	53		5∇	x	6,5	55	70
106	5∇	O	3,1	42	60	212	1	x	2,7	40	36
	1	O	0,9	28	34		2	x	3,4	42	49
	2	O	1,7	28	49		3	x	4,4	42	42
	3	O	2,2	32	42		4∇	x	5,7	42	60
	4∇	O	3,2	32	53		5∇	x	6,9	42	70
112	5∇	O	3,9	35	60	225	1	x	2,8	40	36
	1	O	1,1	28	34		2	x	3,9	42	49
	2	O	1,8	38	49		3	x	4,6	42	42
	3	O	2,4	38	42		4∇	x	6,5	42	60
	4∇	O	3,4	42	53		5∇	x	7,3	42	70
118	5∇	O	4,0	42	60	236	1	x	3,3	38	36
	1	O	1,1	32	34		2	x	4,1	42	49
	2	O	1,8	38	49		3	x	4,9	48	47
	3	O	2,4	42	42		4∇	x	6,2	55	60
	4∇	O	3,4	42	53		5∇	x	7,5	55	70
5∇	O	4,1	48	65							

▲ nur für Profil 13 only for section 13

∇ $d_d + 4$ mm

Anzahl der Rillen No. of grooves z	1	2	3	4	5
Kranzbreite Face width b_2 (mm)	20	35	50	67	82

- Vollscheibe Solid pulley
 - O Bodenscheibe Plate pulley (mit oder ohne Spiegel with or without holes)
 - x Armscheibe Spoked pulley
- Nabenlage: einseitig bündig Hub position: one side flush
 Material: EN-GJL 200 – DIN EN 1561

Profil Section SPA/13

Richt- durchmesser Datum diameter d _d (mm)	Anzahl der Rillen No. of grooves	Aus- führung Type	Gewicht Weight (≈ kg)	Fertig- bohrung Finished bore d _{max} (mm)	Naben- länge Hub length l (mm)	Richt- durchmesser Datum diameter d _d (mm)	Anzahl der Rillen No. of grooves	Aus- führung Type	Gewicht Weight (≈ kg)	Fertig- bohrung Finished bore d _{max} (mm)	Naben- länge Hub length l (mm)
250	1	x	3,4	42	36	400	1∇	x	6,9	50	50
	2	x	4,3	48	49		2∇	x	8,8	55	53
	3	x	5,3	48	47		3∇	x	10,5	60	47
	4∇	x	7,0	55	60		4∇	x	12,4	60	67
	5∇	x	7,9	60	70		5∇	x	15,9	60	82
280	1	x	3,9	42	44	450	1∇	x	7,5	55	50
	2	x	5,4	48	53		2∇	x	9,4	55	53
	3	x	6,5	48	47		3∇	x	12,2	60	47
	4∇	x	8,5	55	60		4∇	x	14,2	65	67
	5∇	x	9,9	60	70		5∇	x	18,3	65	82
300	1	x	4,3	48	44	500	1∇	x	10,5	55	50
	2	x	5,9	48	53		2∇	x	10,7	55	55
	3	x	7,5	55	47		3∇	x	13,5	60	60
	4∇	x	9,8	55	60		4∇	x	16,3	65	67
	5∇	x	11,3	60	70		5∇	x	22,8	65	82
315	1	x	4,8	48	44	560	1∇	x	14,0	55	60
	2	x	6,6	48	53		2∇	x	13,1	55	60
	3	x	8,8	55	47		3∇	x	15,6	60	74
	4∇	x	11,1	55	60		4∇	x	19,4	65	67
	5∇	x	12,5	60	70		5∇	x	24,5	65	82
355	1	x	5,5	48	44						
	2	x	7,7	55	53						
	3	x	9,6	55	47						
	4∇	x	11,8	55	60						
	5∇	x	13,8	60	70						
∇ d _d + 4 mm											

Anzahl der Rillen No. of grooves z	1	2	3	4	5
Kranzbreite Face width b ₂ (mm)	20	35	50	67	82

- Vollscheibe Solid pulley
 - Bodenscheibe Plate pulley (mit oder ohne Spiegel with or without holes)
 - × Armscheibe Spoked pulley
- Nabenlage: einseitig bündig Hub position: one side flush
 Material: EN-GJL 200 – DIN EN 1561

Profil Section SPB/17

Richt- durchmesser Datum diameter d _d (mm)	Anzahl der Rillen No. of grooves	Aus- führung Type	Gewicht Weight (≈ kg)	Fertig- bohrung Finished bore d _{max} (mm)	Naben- länge Hub length l (mm)	Richt- durchmesser Datum diameter d _d (mm)	Anzahl der Rillen No. of grooves	Aus- führung Type	Gewicht Weight (≈ kg)	Fertig- bohrung Finished bore d _{max} (mm)	Naben- länge Hub length l (mm)
56▲	1 2 3	O O O	0,6 1,0 1,1	20 20 22	41 60 62	132▲	1 2 3 4▽ 5▽ 6▽	O O O O O O	1,9 2,6 3,5 6,3 9,4 8,5	30 30 42 42 42 42	41 60 55 70 75 85
63▲	1 2 3	O O O	0,8 1,2 1,2	20 20 22	41 60 62	140	1 2 3 4▽ 5▽ 6▽	O O O O O O	2,1 2,9 3,9 6,9 7,6 11,4	32 38 42 42 48 48	41 60 55 70 75 85
71▲	1 2 3	O O O	0,8 1,3 1,6	22 22 22	41 60 55	150	1 2 3 4▽ 5▽ 6▽	O O O O O O	2,4 3,2 4,3 6,8 8,4 12,1	32 38 42 42 48 48	43 48 60 70 75 85
75▲	1 2 3	O O O	0,8 1,4 1,9	25 25 25	41 60 62	160	1 2 3 4▽ 5▽ 6▽	x x x O O O	2,5 3,3 4,6 7,0 9,4 12,9	38 42 48 48 48 55	43 48 60 70 75 85
80▲	1 2 3 4▽ 5▽	O O O O O	1,0 1,7 2,1 2,4 2,7	28 28 28 28 28	41 60 55 70 80	170	1 2 3 4▽ 5▽ 6▽	x x x O O O	2,9 3,4 4,9 7,2 8,9 13,1	42 42 42 48 48 48	43 48 60 70 75 85
85▲	1 2 3 4▽ 5▽	O O O O O	1,1 1,7 2,2 2,7 3,0	30 30 30 30 30	41 60 55 70 75	180	1 2 3 4▽ 5▽ 6▽	x x x O O O	3,1 3,9 5,3 7,4 9,1 10,8	38 42 48 48 55 60	43 48 60 70 75 85
90▲	1 2 3 4▽ 5▽	O O O O O	1,2 1,8 2,3 3,1 3,3	32 38 38 38 38	41 60 55 70 75	190	1 2 3 4▽ 5▽ 6▽	x x x O O O	3,2 4,2 5,5 7,7 9,2 12,0	42 42 42 48 50 55	43 48 60 70 75 85
95▲	1 2 3 4▽ 5▽	O O O O O	1,3 2,0 2,5 2,9 3,6	35 38 38 38 38	41 60 67 70 75	200	1 2 3 4▽ 5▽ 6▽	x x x O O O	3,4 4,5 5,9 8,0 9,5 12,2	38 42 48 50 55 60	43 48 60 60 80 90
100▲	1 2 3 4▽ 5▽ 6▽	O O O O O O	1,3 2,1 2,9 3,8 4,5 5,2	32 38 38 38 38 38	41 60 55 70 75 124	212	1 2 3 4▽ 5▽ 6▽	x x x O O O	3,8 4,7 6,2 7,7 10,3 13,5	42 42 48 48 50 55	43 48 60 70 80 90
106▲	1 2 3 4▽ 5▽ 6▽	O O O O O O	1,5 2,0 3,0 4,3 5,1 6,0	28 28 30 30 32 32	41 60 55 70 75 124	225	1 2 3 4▽ 5▽ 6▽	x x x O O O	4,0 5,4 6,9 8,6 11,7 14,8	42 42 48 48 50 55	43 48 60 70 90 90
112▲	1 2 3 4▽ 5▽ 6▽	O O O O O O	1,5 2,4 3,1 4,8 5,6 6,2	32 38 38 42 42 42	41 60 55 67 75 85						
118▲	1 2 3 4▽ 5▽ 6▽	O O O O O O	1,6 2,4 3,2 5,2 7,2 6,6	32 38 42 42 42 42	41 60 55 70 75 85						
125▲	1 2 3 4▽ 5▽ 6▽	O O O O O O	1,7 2,6 3,3 4,7 8,6 8,0	32 38 42 42 42 48	41 60 55 70 75 85						

▲ nur für Profil 17 only for section 17

▽ d_d + 5,5 mm

Anzahl der Rillen No. of grooves z	1	2	3	4	5	6
Kranzbreite Face width b ₂ (mm)	25	44	63	86	105	124

- Vollscheibe Solid pulley
 - Bodenscheibe Plate pulley (mit oder ohne Spiegel with or without holes)
 - × Armscheibe Spoked pulley
- Nabenlage: einseitig bündig Hub position: one side flush
 Material: EN-GJL 200 – DIN EN 1561

Profil Section SPB/17

Richt- durchmesser Datum diameter d _d (mm)	Anzahl der Rillen No. of grooves	Aus- führung Type	Gewicht Weight (≈ kg)	Fertig- bohrung Finished bore d _{max} (mm)	Naben- länge Hub length l (mm)	Richt- durchmesser Datum diameter d _d (mm)	Anzahl der Rillen No. of grooves	Aus- führung Type	Gewicht Weight (≈ kg)	Fertig- bohrung Finished bore d _{max} (mm)	Naben- länge Hub length l (mm)
250	1	x	4,2	42	43	400	1∇	x	8,5	50	49
	2	x	6,1	48	55		2∇	x	10,0	55	55
	3	x	8,6	55	60		3∇	x	14,3	60	67
	4∇	x	9,8	60	70		4∇	x	18,5	65	80
	5∇	x	13,2	65	80		5∇	x	22,5	70	85
	6∇	x	17,0	65	90		6∇	x	28,0	75	90
280	1	x	5,7	48	49	450	1∇	x	9,9	50	55
	2	x	7,0	48	55		2∇	x	10,9	55	55
	3	x	9,7	55	60		3∇	x	15,1	60	67
	4∇	x	11,5	60	70		4∇	x	20,5	65	80
	5∇	x	15,5	65	80		5∇	x	26,0	70	80
	6∇	x	18,0	65	90		6∇	x	28,9	75	90
300	1	x	5,9	48	49	500	1∇	x	10,7	50	55
	2	x	7,5	48	55		2∇	x	13,7	60	59
	3	x	10,5	55	67		3∇	x	15,2	65	67
	4∇	x	12,4	60	80		4∇	x	21,3	70	80
	5∇	x	16,5	65	80		5∇	x	30,0	75	80
	6∇	x	18,3	70	90		6∇	x	33,8	80	90
315	1	x	6,4	48	49	560	2∇	x	15,0	60	55
	2	x	8,2	55	55		3∇	x	24,2	65	67
	3	x	12,9	55	67		4∇	x	26,0	70	80
	4∇	x	13,0	60	80		5∇	x	34,4	75	80
	5∇	x	17,6	65	80		6∇	x	39,0	80	90
	6∇	x	20,6	75	90		630	2∇	x	20,2	60
355	1	x	7,0	48	49	3∇		x	27,0	65	80
	2	x	9,7	55	55	4∇		x	30,8	75	86
	3	x	13,4	55	67	5∇		x	37,2	80	90
	4∇	x	18,3	60	80	6∇		x	44,0	90	100
	5∇	x	18,8	65	75						
	6∇	x	19,8	75	90						
∇ d _d + 5,5 mm											

Anzahl der Rillen No. of grooves z	1	2	3	4	5	6
Kranzbreite Face width b ₂ (mm)	25	44	63	86	105	124

- Vollscheibe *Solid pulley*
 - Bodenscheibe *Plate pulley*
(mit oder ohne Spiegel *with or without holes*)
 - × Armscheibe *Spoked pulley*
- Nabenlage: einseitig bündig *Hub position: one side flush*
 Material: EN-GJL 200 – DIN EN 1561

Profil Section SPC/22 (keine Lagerware *non stock items*)

Richt- durchmesser Datum diameter d _d (mm)	Anzahl der Rillen No. of grooves	Aus- führung Type	Gewicht Weight (≈ kg)	Fertig- bohrung Finished bore d _{max} (mm)	Naben- länge Hub length l (mm)	Richt- durchmesser Datum diameter d _d (mm)	Anzahl der Rillen No. of grooves	Aus- führung Type	Gewicht Weight (≈ kg)	Fertig- bohrung Finished bore d _{max} (mm)	Naben- länge Hub length l (mm)	
180	1	O	4,2	40	54	335	2	x	14,0	55	74	
	2	O	7,2	50	64		3	x	18,3	55	90	
	3	O	10,4	55	90		4	x	22,4	60	95	
	4	O	10,5	55	95		5	x	28,3	65	100	
	5	O	18,0	60	100		6	x	34,4	75	115	
	6	O	23,6	65	115							
200	1	O	4,8	40	54	355	2	x	15,2	60	74	
	2	O	7,8	50	64		3	x	19,2	70	90	
	3	O	8,8	55	90		4	x	25,8	70	95	
	4	O	11,2	60	95		5	x	32,0	75	100	
	5	O	15,4	65	100		6	x	36,2	75	115	
	6	O	27,0	70	125							
225	1	x	5,5	48	54	400	3	x	20,6	70	90	
	2	x	7,8	52	64		4	x	28,0	70	105	
	3	x	10,6	52	90		5	x	32,0	75	100	
	4	x	13,1	55	95							
	5	x	16,7	60	100		450	2	x	21,1	70	80
	6	x	35,0	60	115			3	x	26,3	75	90
					4	x		31,1	75	105		
					5	x		42,2	80	110		
					6	x		48,5	80	120		
250	1	x	7,3	52	54	500	3	x	28,4	75	90	
	2	x	8,8	52	64		4	x	34,1	75	105	
	3	x	11,0	65	90		5	x	48,2	80	110	
	4	x	15,3	70	95		6	x	52,5	80	120	
	5	x	19,0	75	100							
	6	x	23,7	60	115		560	3	x	31,1	75	90
					4	x		39,0	75	105		
					5	x		54,1	80	110		
					6	x		61,5	85	120		
280	1	x	8,7	52	54	630	3	x	38,5	80	90	
	2	x	10,9	55	64		4	x	48,1	80	105	
	3	x	15,6	70	90		5	x	62,2	85	110	
	4	x	17,5	75	95		6	x	73,2	85	120	
	5	x	20,5	75	100							
315	1	x	9,1	52	54							
	2	x	13,0	55	74							
	3	x	17,1	70	90							
	4	x	20,0	75	95							
	5	x	24,7	80	100							
	6	x	31,2	85	115							

Anzahl der Rillen No. of grooves z	1	2	3	4	5	6
Kranzbreite Face width b ₂ (mm)	38	64	90	116	142	168

● Vollscheibe *Solid pulley*
 ○ Bodenscheibe *Plate pulley*
 (mit oder ohne Spiegel *with or without holes*)
 × Armscheibe *Spoked pulley*
 Nabenslage: einseitig bündig *Hub position: one side flush*
 Material: EN-GJL 200 – DIN EN 1561



Regelscheiben für zylindrische Bohrung <i>Variable speed pulleys for plain boring</i> Material: GG									
Bezeichnung Part number	D _A (mm)	D (mm)	Fertigbohrung Finished bore d _{max} (mm)	B (mm)	Profil Section	d _{d min} (mm)	d _{d max} (mm)	Regel- faktor Variance factor	Gewicht Weight (≈ kg)
R 083-1	83	40	26	48	SPZ	63	79	1,25	0,90
					Z/10	57	77	1,35	
R 093-1	93	45	28	48	SPZ	67	89	1,33	1,03
					SPA	66	87	1,32	
					Z/10	61	87	1,43	
					A/13	60	85	1,42	
R 108-1	108	50	28	48	SPZ	79	94	1,19	1,65
					SPA	81	102	1,26	
					Z/10	73	93	1,27	
					A/13	75	100	1,33	
R 121-1	121	55	28	48	SPZ	92	107	1,16	1,75
					SPA	94	115	1,22	
					Z/10	86	106	1,23	
					A/13	88	113	1,28	
R 138-1	138	55	38	48	SPZ	109	124	1,14	2,60
					SPA	111	132	1,19	
					SPB	116	131	1,13	
					Z/10	103	123	1,19	
					A/13	105	130	1,24	
					B/17	109	128	1,17	
R 160-1	160	80	52	48	SPZ	119	134	1,13	4,50
					SPA	121	143	1,18	
					SPB	126	153	1,21	
					Z/10	113	133	1,18	
					A/13	115	141	1,23	
					B/17	119	150	1,26	
R 180-1	180	80	52	48	SPA	141	163	1,16	5,40
					SPB	146	173	1,18	
					A/13	135	161	1,19	
					B/17	139	170	1,22	



Regelscheiben für zylindrische Bohrung <i>Variable speed pulleys for plain boring</i> Material: GG									
Bezeichnung Part number	D _A (mm)	D (mm)	Fertigbohrung Finished bore d _{max} (mm)	B (mm)	Profil Section	d _{d min} (mm)	d _{d max} (mm)	Regel- faktor Variance factor	Gewicht Weight (≈ kg)
R 083-2	83	40	26	76	SPZ	63	79	1,25	1,50
					Z/10	57	77	1,35	
R 093-2	93	45	28	76	SPZ	67	89	1,33	1,75
					SPA	66	87	1,32	
					Z/10	61	87	1,43	
					A/13	60	85	1,42	
R 108-2	108	50	28	76	SPZ	79	94	1,19	2,15
					SPA	81	102	1,26	
					Z/10	73	93	1,27	
					A/13	75	100	1,33	
R 121-2	121	55	28	76	SPZ	92	107	1,16	2,70
					SPA	94	115	1,22	
					Z/10	86	106	1,23	
					A/13	88	113	1,28	
R 138-2	138	55	38	76	SPZ	109	124	1,14	4,50
					SPA	111	132	1,19	
					SPB	116	131	1,13	
					Z/10	103	123	1,19	
					A/13	105	130	1,24	
					B/17	109	128	1,17	
R 160-2	160	80	52	90	SPZ	119	134	1,13	7,50
					SPA	121	143	1,18	
					SPB	126	153	1,21	
					Z/10	113	133	1,18	
					A/13	115	141	1,23	
					B/17	119	150	1,26	
R 180-2	180	80	52	90	SPA	141	163	1,16	9,20
					SPB	146	173	1,18	
					A/13	135	161	1,19	
					B/17	139	170	1,22	



Regelscheiben für Taper-Buchsen <i>Variable speed pulleys for taper bushes</i>										Material: GG
Bezeichnung Part number	D _A (mm)	D (mm)	Fertigbohrung Finished bore d _{max} (mm)	B (mm)	Profil Section	d _{d min} (mm)	d _{d max} (mm)	Regel- faktor Variance factor	Gewicht ohne Buchse Weight without bush (≈ kg)	Taper- Buchse Taper bush
TB-R 092-1	92	46	25	31	SPZ Z/10	60 55	89 88	1,48 1,60	0,85	1008
TB-R 108-1	108	50	28	35	SPZ SPA Z/10 A/13 B/17	75 76 68 70 87	93 102 92 100 97	1,24 1,34 1,35 1,43 1,11	1,20	1108
TB-R 120-1	120	55	28	35	SPZ SPA Z/10 A/13 B/17	87 88 80 82 98	105 114 104 112 108	1,20 1,29 1,30 1,36 1,10	1,50	1108
TB-R 138-1	138	65	32	38	SPZ SPA Z/10 A/13 B/17	105 106 98 100 116	123 132 122 130 126	1,17 1,24 1,24 1,30 1,09	2,20	1215
TB-R 159-1	159	75	42	39	SPZ SPA Z/10 A/13 B/17	126 128 122 128 125	144 154 152 152 148	1,14 1,20 1,24 1,18 1,18	3,50	1615
TB-R 180-1	180	75	42	45	SPZ SPA SPB Z/10 A/13 B/17	133 134 137 128 128 132	151 160 173 151 158 170	1,14 1,19 1,26 1,17 1,23 1,29	4,20	1615

Taper-Buchse Taper bush	1008	1108	1215	1615
Bohrung d ₂ (mm) von ... bis ... Bore d ₂ (mm) from ... to ...	10-25	10-28	11-32	14-42

GG = Grauguss Cast iron

Fertigungstechnische Änderungen vorbehalten. We reserve the right to technical changes.

Bohrungsdurchmesser d₂ siehe Seite 89.
Bore diameters d₂ see page 89.

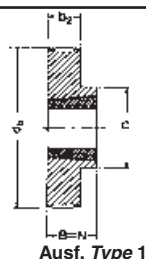

Bezeichnung Part number	Anzahl der Rillen No. of ribs	Aus- führung Type	Material	d _b (mm)	b ₂ (mm)	B (mm)	N (mm)	D (mm)	Taper- Buchse Taper bush
TB 4 PJ 47,5	4	1	GG	47,5	13	23	23	47,5	1008
TB 4 PJ 52,5	4	1	GG	52,5	13	23	23	47,5	1008
TB 4 PJ 57,5	4	1	GG	57,5	13	23	23	54,0	1108
TB 4 PJ 62,5	4	1	GG	62,5	13	23	23	54,0	1108
TB 4 PJ 67,5	4	1	GG	67,5	13	23	23	54,0	1108
TB 4 PJ 72,5	4	1	GG	72,5	13	23	23	54,0	1108
TB 4 PJ 77,5	4	1	GG	77,5	13	26	26	70,0	1210
TB 4 PJ 82,5	4	1	GG	82,5	13	26	26	78,0	1210
TB 4 PJ 87,5	4	1	GG	87,5	13	26	26	78,0	1210
TB 4 PJ 92,5	4	1	GG	92,5	13	26	26	78,0	1210
TB 4 PJ 97,5	4	1	GG	97,5	13	26	26	78,0	1210
TB 4 PJ 102,5	4	1	GG	102,5	13	26	26	85,0	1610
TB 4 PJ 107,5	4	1	GG	107,5	13	26	26	85,0	1610
TB 4 PJ 112,5	4	1	GG	112,5	13	26	26	85,0	1610
TB 4 PJ 117,5	4	1	GG	117,5	13	26	26	85,0	1610
TB 4 PJ 122,5	4	1	GG	122,5	13	26	26	85,0	1610
TB 4 PJ 127,5	4	1	GG	127,5	13	26	26	85,0	1610
TB 4 PJ 137,5	4	1	GG	137,5	13	26	26	85,0	1610
TB 4 PJ 152,5	4	1	GG	152,5	13	26	26	85,0	1610
TB 4 PJ 162,5	4	1	GG	162,5	13	26	26	85,0	1610
TB 4 PJ 172,5	4	1	GG	172,5	13	26	26	85,0	1610
TB 4 PJ 182,5	4	1	GG	182,5	13	26	26	85,0	1610
TB 4 PJ 192,5	4	1	GG	192,5	13	26	26	85,0	1610
TB 4 PJ 202,5	4	1	GG	202,5	13	33	33	100,0	2012
TB 4 PJ 222,5	4	1	GG	222,5	13	33	33	100,0	2012
TB 8 PJ 47,5	8	4	GG	47,5	23	23	23	—	1008
TB 8 PJ 52,5	8	4	GG	52,5	23	23	23	—	1008
TB 8 PJ 57,5	8	4	GG	57,5	23	23	23	—	1108
TB 8 PJ 62,5	8	4	GG	62,5	23	23	23	—	1108
TB 8 PJ 67,5	8	4	GG	67,5	23	23	23	—	1108
TB 8 PJ 72,5	8	4	GG	72,5	23	23	23	—	1108
TB 8 PJ 77,5	8	1	GG	77,5	23	26	26	70,0	1210
TB 8 PJ 82,5	8	1	GG	82,5	23	26	26	78,0	1210
TB 8 PJ 87,5	8	1	GG	87,5	23	26	26	78,0	1210
TB 8 PJ 92,5	8	1	GG	92,5	23	26	26	78,0	1210
TB 8 PJ 97,5	8	1	GG	97,5	23	26	26	78,0	1210
TB 8 PJ 102,5	8	1	GG	102,5	23	26	26	85,0	1610
TB 8 PJ 107,5	8	1	GG	107,5	23	26	26	85,0	1610
TB 8 PJ 112,5	8	1	GG	112,5	23	26	26	85,0	1610
TB 8 PJ 117,5	8	1	GG	117,5	23	26	26	85,0	1610
TB 8 PJ 122,5	8	1	GG	122,5	23	26	26	85,0	1610
TB 8 PJ 127,5	8	1	GG	127,5	23	26	26	85,0	1610
TB 8 PJ 137,5	8	1	GG	137,5	23	26	26	85,0	1610
TB 8 PJ 152,5	8	1	GG	152,5	23	26	26	85,0	1610
TB 8 PJ 162,5	8	1	GG	162,5	23	26	26	85,0	1610
TB 8 PJ 172,5	8	1	GG	172,5	23	26	26	85,0	1610
TB 8 PJ 182,5	8	1	GG	182,5	23	26	26	85,0	1610
TB 8 PJ 192,5	8	1	GG	192,5	23	26	26	85,0	1610
TB 8 PJ 202,5	8	1	GG	202,5	23	33	33	100,0	2012
TB 8 PJ 222,5	8	1	GG	222,5	23	33	33	100,0	2012

GG = Grauguss Cast iron
 Weitere Abmessungen auf Anfrage.
 Further sizes on request.

Fertigungstechnische Änderungen vorbehalten.
 We reserve the right to make technical changes.
 Bohrungsdurchmesser d₂ siehe Seite 89.
 Bore diameters d₂ see page 89.

Taper-Buchse Taper bush	1008	1108	1210	1610	2012
Bohrung d ₂ (mm) von ... bis ... Bore d ₂ (mm) from ... to ...	10-25	10-28	11-32	14-42	14-50

optibelt RBS Keilrippenscheiben für Taper-Buchsen, Profil PJ
Ribbed belt pulleys for taper bushes, section PJ

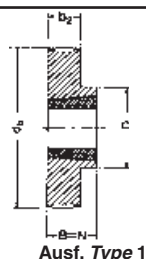

Bezeichnung Part number	Anzahl der Rillen No. of ribs	Aus- führung Type	Material	d_b (mm)	b_2 (mm)	B (mm)	N (mm)	D (mm)	Taper- Buchse Taper bush
TB 12 PJ 62,5	12	2	GG	62,5	32	32	23	50,0	1108
TB 12 PJ 67,5	12	2	GG	67,5	32	32	23	50,0	1108
TB 12 PJ 72,5	12	2	GG	72,5	32	32	23	50,0	1108
TB 12 PJ 77,5	12	2	GG	77,5	32	32	26	62,0	1210
TB 12 PJ 82,5	12	2	GG	82,5	32	32	26	62,0	1210
TB 12 PJ 87,5	12	2	GG	87,5	32	32	26	70,0	1610
TB 12 PJ 92,5	12	2	GG	92,5	32	32	26	70,0	1610
TB 12 PJ 97,5	12	2	GG	97,5	32	32	26	70,0	1610
TB 12 PJ 102,5	12	2	GG	102,5	32	32	26	70,0	1610
TB 12 PJ 107,5	12	2	GG	107,5	32	32	26	70,0	1610
TB 12 PJ 112,5	12	2	GG	112,5	32	32	26	70,0	1610
TB 12 PJ 117,5	12	2	GG	117,5	32	32	26	70,0	1610
TB 12 PJ 122,5	12	2	GG	122,5	32	32	26	70,0	1610
TB 12 PJ 127,5	12	1	GG	127,5	32	32	33	100,0	2012
TB 12 PJ 137,5	12	1	GG	137,5	32	32	33	100,0	2012
TB 12 PJ 152,5	12	1	GG	152,5	32	32	33	100,0	2012
TB 12 PJ 162,5	12	1	GG	162,5	32	32	33	100,0	2012
TB 12 PJ 172,5	12	1	GG	172,5	32	32	33	100,0	2012
TB 12 PJ 182,5	12	1	GG	182,5	32	46	46	110,0	2517
TB 12 PJ 192,5	12	1	GG	192,5	32	46	46	110,0	2517
TB 12 PJ 202,5	12	1	GG	202,5	32	46	46	110,0	2517
TB 12 PJ 222,5	12	1	GG	222,5	32	46	46	110,0	2517
TB 16 PJ 62,5	16	2	GG	62,5	41	41	23	50,0	1108
TB 16 PJ 67,5	16	2	GG	67,5	41	41	23	50,0	1108
TB 16 PJ 72,5	16	2	GG	72,5	41	41	26	62,0	1210
TB 16 PJ 77,5	16	2	GG	77,5	41	41	26	62,0	1210
TB 16 PJ 82,5	16	2	GG	82,5	41	41	26	62,0	1210
TB 16 PJ 87,5	16	2	GG	87,5	41	41	26	70,0	1610
TB 16 PJ 92,5	16	2	GG	92,5	41	41	26	70,0	1610
TB 16 PJ 97,5	16	2	GG	97,5	41	41	26	70,0	1610
TB 16 PJ 102,5	16	2	GG	102,5	41	41	26	70,0	1610
TB 16 PJ 107,5	16	2	GG	107,5	41	41	26	70,0	1610
TB 16 PJ 112,5	16	2	GG	112,5	41	41	33	85,0	2012
TB 16 PJ 117,5	16	2	GG	117,5	41	41	33	85,0	2012
TB 16 PJ 122,5	16	2	GG	122,5	41	41	33	85,0	2012
TB 16 PJ 127,5	16	2	GG	127,5	41	41	33	85,0	2012
TB 16 PJ 137,5	16	2	GG	137,5	41	41	33	85,0	2012
TB 16 PJ 152,5	16	2	GG	152,5	41	41	33	85,0	2012
TB 16 PJ 162,5	16	2	GG	162,5	41	41	33	85,0	2012
TB 16 PJ 172,5	16	2	GG	172,5	41	41	33	85,0	2012
TB 16 PJ 182,5	16	1	GG	182,5	41	46	46	110,0	2517
TB 16 PJ 192,5	16	1	GG	192,5	41	46	46	110,0	2517
TB 16 PJ 202,5	16	1	GG	202,5	41	46	46	110,0	2517
TB 16 PJ 222,5	16	1	GG	222,5	41	46	46	110,0	2517

GG = Grauguss Cast iron
 Weitere Abmessungen auf Anfrage.
 Further sizes on request.

Fertigungstechnische Änderungen vorbehalten.
 We reserve the right to make technical changes.
 Bohrungsdurchmesser d_2 siehe Seite 89.
 Bore diameters d_2 see page 89.

Taper-Buchse Taper bush	1108	1210	1610	2012	2517
Bohrung d_2 (mm) von ... bis ... Bore d_2 (mm) from ... to ...	10-28	11-32	14-42	14-50	16-60

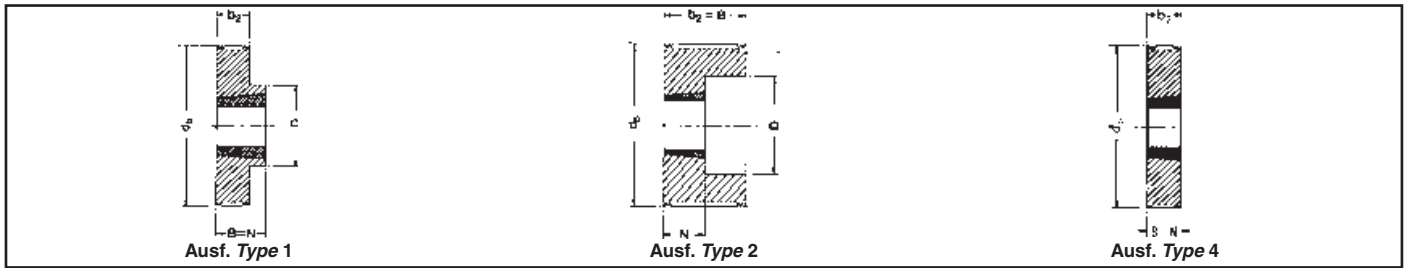

Bezeichnung Part number	Anzahl der Rillen No. of ribs	Aus- führung Type	Material	d_b (mm)	b_2 (mm)	B (mm)	N (mm)	D (mm)	Taper- Buchse Taper bush
TB 6 PL 78	6	2	GG	78	33	33	26	62,0	1210
TB 6 PL 83	6	2	GG	83	33	33	26	62,0	1210
TB 6 PL 88	6	2	GG	88	33	33	26	70,0	1610
TB 6 PL 93	6	2	GG	93	33	33	26	70,0	1610
TB 6 PL 98	6	2	GG	98	33	33	26	70,0	1610
TB 6 PL 103	6	2	GG	103	33	33	26	70,0	1610
TB 6 PL 108	6	2	GG	108	33	33	26	70,0	1610
TB 6 PL 113	6	2	GG	113	33	33	26	70,0	1610
TB 6 PL 118	6	2	GG	118	33	33	26	70,0	1610
TB 6 PL 123	6	4	GG	123	33	33	33	—	2012
TB 6 PL 133	6	4	GG	133	33	33	33	—	2012
TB 6 PL 148	6	4	GG	148	33	33	33	—	2012
TB 6 PL 158	6	4	GG	158	33	33	33	—	2012
TB 6 PL 168	6	4	GG	168	33	33	33	—	2012
TB 6 PL 178	6	1	GG	178	33	46	46	110,0	2517
TB 6 PL 188	6	1	GG	188	33	46	46	110,0	2517
TB 6 PL 198	6	1	GG	198	33	46	46	110,0	2517
TB 6 PL 218	6	1	GG	218	33	46	46	110,0	2517
TB 6 PL 238	6	1	GG	238	33	46	46	110,0	2517
TB 6 PL 258	6	1	GG	258	33	46	46	110,0	2517
TB 6 PL 278	6	1	GG	278	33	46	46	110,0	2517
TB 6 PL 298	6	1	GG	298	33	46	46	110,0	2517
TB 6 PL 318	6	1	GG	318	33	46	46	110,0	2517
TB 6 PL 348	6	1	GG	348	33	46	46	110,0	2517
TB 6 PL 388	6	1	GG	388	33	46	46	110,0	2517
TB 8 PL 78	8	2	GG	78	42	42	26	62,0	1210
TB 8 PL 83	8	2	GG	83	42	42	26	62,0	1210
TB 8 PL 88	8	2	GG	88	42	42	26	70,0	1610
TB 8 PL 93	8	2	GG	93	42	42	26	70,0	1610
TB 8 PL 98	8	2	GG	98	42	42	26	70,0	1610
TB 8 PL 103	8	2	GG	103	42	42	33	85,0	2012
TB 8 PL 108	8	2	GG	108	42	42	33	85,0	2012
TB 8 PL 113	8	2	GG	113	42	42	33	85,0	2012
TB 8 PL 118	8	2	GG	118	42	42	33	85,0	2012
TB 8 PL 123	8	2	GG	123	42	42	33	85,0	2012
TB 8 PL 133	8	2	GG	133	42	42	33	85,0	2012
TB 8 PL 148	8	2	GG	148	42	42	33	85,0	2012
TB 8 PL 158	8	2	GG	158	42	42	33	85,0	2012
TB 8 PL 168	8	2	GG	168	42	42	33	85,0	2012
TB 8 PL 178	8	1	GG	178	42	46	46	110,0	2517
TB 8 PL 188	8	1	GG	188	42	46	46	110,0	2517
TB 8 PL 198	8	1	GG	198	42	46	46	110,0	2517
TB 8 PL 218	8	1	GG	218	42	46	46	110,0	2517
TB 8 PL 238	8	1	GG	238	42	46	46	110,0	2517
TB 8 PL 258	8	1	GG	258	42	46	46	110,0	2517
TB 8 PL 278	8	1	GG	278	42	46	46	110,0	2517
TB 8 PL 298	8	1	GG	298	42	46	46	110,0	2517
TB 8 PL 318	8	1	GG	318	42	46	46	110,0	2517
TB 8 PL 348	8	1	GG	348	42	46	46	110,0	2517
TB 8 PL 388	8	1	GG	388	42	46	46	110,0	2517

GG = Grauguss Cast iron
 Weitere Abmessungen auf Anfrage.
 Further sizes on request.

Fertigungstechnische Änderungen vorbehalten.
 We reserve the right to make technical changes.
 Bohrungsdurchmesser d_2 siehe Seite 89.
 Bore diameters d_2 see page 89.

Taper-Buchse Taper bush	1210	1610	2012	2517
Bohrung d_2 (mm) von ... bis ... Bore d_2 (mm) from ... to ...	11-32	14-42	14-50	16-60

optibelt RBS Keilrippenscheiben für Taper-Buchsen, Profil PL (keine Lagerware)
Ribbed belt pulleys for taper bushes, section PL (non stock items)

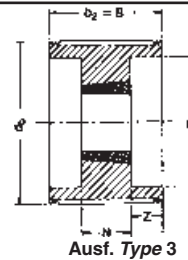
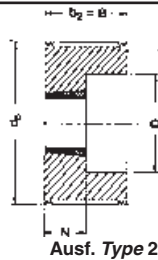

Bezeichnung Part number	Anzahl der Rillen No. of ribs	Aus- führung Type	Material	d_b (mm)	b_2 (mm)	B (mm)	N (mm)	D (mm)	Taper- Buchse Taper bush
TB 10 PL 88	10	3	GG	88	53	53	26	70,0	1610
TB 10 PL 93	10	3	GG	93	53	53	26	70,0	1610
TB 10 PL 98	10	3	GG	98	53	53	26	70,0	1610
TB 10 PL 103	10	2	GG	103	53	53	33	85,0	2012
TB 10 PL 108	10	2	GG	108	53	53	33	85,0	2012
TB 10 PL 113	10	2	GG	113	53	53	33	85,0	2012
TB 10 PL 118	10	2	GG	118	53	53	33	85,0	2012
TB 10 PL 123	10	2	GG	123	53	53	33	85,0	2012
TB 10 PL 133	10	2	GG	133	53	53	33	85,0	2012
TB 10 PL 148	10	2	GG	148	53	53	33	85,0	2012
TB 10 PL 158	10	2	GG	158	53	53	33	85,0	2012
TB 10 PL 168	10	2	GG	168	53	53	33	85,0	2012
TB 10 PL 178	10	2	GG	178	53	53	46	105,0	2517
TB 10 PL 188	10	2	GG	188	53	53	46	105,0	2517
TB 10 PL 198	10	2	GG	198	53	53	46	105,0	2517
TB 10 PL 218	10	2	GG	218	53	53	46	105,0	2517
TB 10 PL 238	10	2	GG	238	53	53	46	105,0	2517
TB 10 PL 258	10	2	GG	258	53	53	46	105,0	2517
TB 10 PL 278	10	2	GG	278	53	53	46	105,0	2517
TB 10 PL 298	10	2	GG	298	53	53	46	105,0	2517
TB 10 PL 318	10	2	GG	318	53	53	46	105,0	2517
TB 10 PL 348	10	2	GG	348	53	53	46	105,0	2517
TB 10 PL 388	10	2	GG	388	53	53	46	105,0	2517
TB 12 PL 88	12	3	GG	88	62	62	26	70,0	1610
TB 12 PL 93	12	3	GG	93	62	62	26	70,0	1610
TB 12 PL 98	12	3	GG	98	62	62	26	70,0	1610
TB 12 PL 103	12	3	GG	103	62	62	33	85,0	2012
TB 12 PL 108	12	3	GG	108	62	62	33	85,0	2012
TB 12 PL 113	12	3	GG	113	62	62	33	85,0	2012
TB 12 PL 118	12	3	GG	118	62	62	33	85,0	2012
TB 12 PL 123	12	3	GG	123	62	62	33	85,0	2012
TB 12 PL 133	12	3	GG	133	62	62	33	85,0	2012
TB 12 PL 148	12	2	GG	148	62	62	46	105,0	2517
TB 12 PL 158	12	2	GG	158	62	62	46	105,0	2517
TB 12 PL 168	12	2	GG	168	62	62	46	105,0	2517
TB 12 PL 178	12	2	GG	178	62	62	46	105,0	2517
TB 12 PL 188	12	2	GG	188	62	62	46	105,0	2517
TB 12 PL 198	12	2	GG	198	62	62	46	105,0	2517
TB 12 PL 218	12	2	GG	218	62	62	46	105,0	2517
TB 12 PL 238	12	2	GG	238	62	62	52	130,0	3020
TB 12 PL 258	12	2	GG	258	62	62	52	130,0	3020
TB 12 PL 278	12	2	GG	278	62	62	52	130,0	3020
TB 12 PL 298	12	2	GG	298	62	62	52	130,0	3020
TB 12 PL 318	12	2	GG	318	62	62	52	130,0	3020
TB 12 PL 348	12	2	GG	348	62	62	52	130,0	3020
TB 12 PL 388	12	2	GG	388	62	62	52	130,0	3020

GG = Grauguss Cast iron
 Weitere Abmessungen auf Anfrage.
 Further sizes on request.

Fertigungstechnische Änderungen vorbehalten.
 We reserve the right to make technical changes.
 Bohrungsdurchmesser d_2 siehe Seite 89.
 Bore diameters d_2 see page 89.

Taper-Buchse Taper bush	1610	2012	2517	3020
Bohrung d_2 (mm) von ... bis ... Bore d_2 (mm) from ... to ...	14-42	14-50	16-60	25-75

optibelt RBS Keilrippenscheiben für Taper-Buchsen, Profil PL (keine Lagerware)
Ribbed belt pulleys for taper bushes, section PL (non stock items)

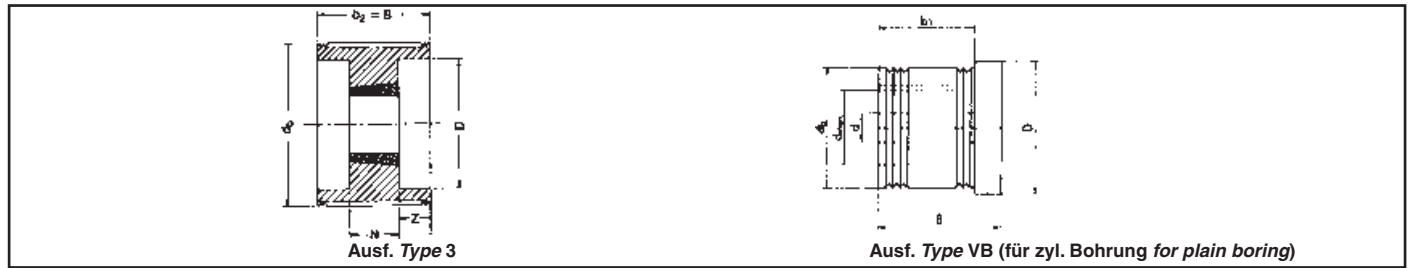

Bezeichnung Part number	Anzahl der Rillen No. of ribs	Aus- führung Type	Material	d _b (mm)	b ₂ (mm)	B (mm)	N (mm)	D (mm)	Taper- Buchse Taper bush
TB 16 PL 103	16	3	GG	103	80	80	33	85,0	2012
TB 16 PL 108	16	3	GG	108	80	80	33	85,0	2012
TB 16 PL 113	16	3	GG	113	80	80	33	85,0	2012
TB 16 PL 118	16	3	GG	118	80	80	33	85,0	2012
TB 16 PL 123	16	3	GG	123	80	80	33	85,0	2012
TB 16 PL 133	16	3	GG	133	80	80	33	85,0	2012
TB 16 PL 148	16	3	GG	148	80	80	46	105,0	2517
TB 16 PL 158	16	3	GG	158	80	80	46	105,0	2517
TB 16 PL 168	16	3	GG	168	80	80	46	105,0	2517
TB 16 PL 178	16	3	GG	178	80	80	46	105,0	2517
TB 16 PL 188	16	3	GG	188	80	80	46	105,0	2517
TB 16 PL 198	16	3	GG	198	80	80	46	105,0	2517
TB 16 PL 218	16	3	GG	218	80	80	46	105,0	2517
TB 16 PL 238	16	3	GG	238	80	80	52	130,0	3020
TB 16 PL 258	16	3	GG	258	80	80	52	130,0	3020
TB 16 PL 278	16	3	GG	278	80	80	52	130,0	3020
TB 16 PL 298	16	3	GG	298	80	80	52	130,0	3020
TB 16 PL 318	16	3	GG	318	80	80	52	130,0	3020
TB 16 PL 348	16	3	GG	348	80	80	52	130,0	3020
TB 16 PL 388	16	3	GG	388	80	80	52	130,0	3020

Taper-Buchse Taper bush	2012	2517	3020
Bohrung d ₂ (mm) von ... bis ... Bore d ₂ (mm) from ... to ...	14-50	16-60	25-75

Bohrungsdurchmesser d₂ siehe Seite 89.
 Bore diameters d₂ see page 89.

optibelt RBS Keilrippenscheiben mit zylindrischer Bohrung, Profil PJ
Ribbed belt pulleys for plain boring, section PJ

Bezeichnung Part number	Anzahl der Rillen No. of ribs	Aus- führung Type	Material	d _b (mm)	b ₁ (mm)	B (mm)	D (mm)	Vorbohrung Pilot bore d (mm)	Fertig- bohrung Finished bore d _{max} (mm)	Gewicht Weight (≈ kg)
4 PJ 22,5	4	VB	GG	22,5	13	20	25	8	12,0	0,045
4 PJ 27,5	4	VB	GG	27,5	13	20	30	8	14,0	0,070
4 PJ 32,5	4	VB	GG	32,5	13	20	35	8	18,0	0,100
4 PJ 37,5	4	VB	GG	37,5	13	20	40	8	20,0	0,135
4 PJ 42,5	4	VB	GG	42,5	13	20	45	8	22,0	0,180
8 PJ 22,5	8	VB	GG	22,5	23	30	25	8	12,0	0,063
8 PJ 27,5	8	VB	GG	27,5	23	30	30	8	14,0	0,100
8 PJ 32,5	8	VB	GG	32,5	23	30	35	8	18,0	0,150
8 PJ 37,5	8	VB	GG	37,5	23	30	40	8	20,0	0,200
8 PJ 42,5	8	VB	GG	42,5	23	30	45	8	22,0	0,265
12 PJ 22,5	12	VB	GG	22,5	32	40	25	8	12,0	0,086
12 PJ 27,5	12	VB	GG	27,5	32	40	30	8	14,0	0,140
12 PJ 32,5	12	VB	GG	32,5	32	40	35	8	18,0	0,200
12 PJ 37,5	12	VB	GG	37,5	32	40	40	8	20,0	0,280
12 PJ 42,5	12	VB	GG	42,5	32	40	45	8	22,0	0,360

GG = Grauguss Cast iron

Weitere Abmessungen auf Anfrage. Further sizes on request.

Fertigungstechnische Änderungen vorbehalten. We reserve the right to make technical changes.



Außendurchmesser x Breite <i>Outside diameter x width (mm)</i>	Taper-Buchse <i>Taper bush</i>	Außendurchmesser x Breite <i>Outside diameter x width (mm)</i>	Taper-Buchse <i>Taper bush</i>
63 x 50	1108	224 x 50	2517
80 x 50	1210	224 x 80	2517
80 x 80	1615	224 x 100	3020
90 x 50	1615	224 x 125	3030
90 x 80	1615	224 x 160	3030
90 x 100	1615	250 x 80	2517
100 x 50	1615	250 x 100	3020
100 x 80	1615	250 x 125	3030
100 x 100	1615	250 x 160	3030
125 x 50	2012	280 x 100	3020
125 x 80	2517	280 x 125	3030
125 x 100	2517	280 x 160	3535
125 x 125	2517	280 x 200	4040
140 x 50	2012	315 x 100	3020
140 x 80	2517	315 x 125	3030
140 x 100	3020	315 x 160	3535
140 x 125	3030	315 x 200	4040
150 x 50	2012	355 x 100	3030
150 x 80	2517	355 x 125	3030
150 x 100	3020	355 x 160	3535
150 x 125	3030	355 x 200	4040
150 x 160	3030	400 x 100	3535
160 x 50	2012	400 x 125	3535
160 x 80	2517	400 x 160	3535
160 x 100	3020	400 x 200	4040
160 x 125	3030	450 x 160	3535
160 x 160	3030	450 x 200	4040
180 x 80	2517	500 x 160	4040
180 x 100	3020	500 x 200	4545
180 x 125	3030	560 x 160	4040
180 x 160	3030	560 x 200	4545
200 x 80	2517	630 x 160	4545
200 x 100	3020	630 x 200	5050
200 x 125	3030		
200 x 160	3030		

Taper-Buchse <i>Taper bush</i>	1108	1210	1615	2012	2517	3020	3030	3535	4040	4545	5050
Bohrung d ₂ (mm) von ... bis ... <i>Bore d₂ (mm) from ... to ...</i>	10-28	11-32	14-42	14-50	16-60	25-75	35-75	35-90	40-100	55-110	70-125

Bohrungsdurchmesser d₂ siehe Seite 89.
Bore diameters d₂ see page 89.

Material: EN-GJL 200 – DIN EN 1561
Material: EN-GJL 200 – DIN EN 1561

Fertigungstechnische Änderungen vorbehalten.
We reserve the right to make technical changes.

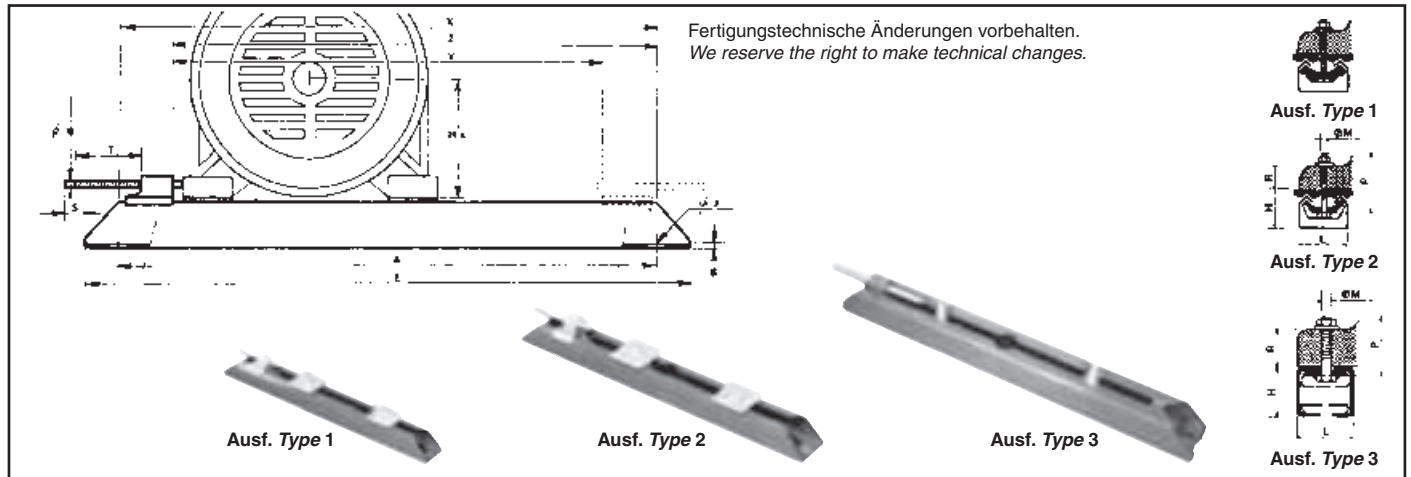

Bezeichnung Part number	S71/6VS	N300/6VS	S100/8VS	N400/8VS	S132/10VS	N600/10VS	S180/12VS	S225/16GS	S280/20GS	S355/24GS
Ausführung Type	1	1	2	2	2	2	2	3	3	3
Motorachshöhe Motor shaft centre height Ha (mm)	56/63/71	80	80/90/100	100/112	100/112/132	160	160/180	200/225	250/280	315/355
Abmessungen Dimensions	A (mm)	280,0	343,0	355,0	455,0	480,0	580,0	630,0	800,0	1000,0
	E (mm)	312,0	375,0	395,0	495,0	530,0	630,0	686,0	864,0	1072,0
	H (mm)	28,0	28,0	40,0	40,0	49,5	49,5	60,5	75,0	100,0
	Ø J (mm)	10,5	10,5	13,0	13,0	15,0	15,0	19,0	24,0	30,0
	K (mm)	1,5	1,5	2,5	2,5	7,0	7,0	7,0	28,5	35,0
	L (mm)	40,2	40,2	50,0	50,0	60,0	60,0	75,0	90,0	112,0
	Ø M (mm)	6,0	6,0	8,0	8,0	10,0	10,0	12,0	16,0	20,0
	P (mm)	35,0	35,0	45,0	45,0	55,0	55,0	70,0	70,0	80,0
	R (mm)	13,0	13,0	18,5	18,5	23,5	23,5	34,0	41,0	48,0
	S (mm)	20,0	20,0	30,0	32,0	37,0	37,0	50,0	167,0	200,0
T (mm)	75,0	75,0	97,0	97,0	119,0	119,0	154,0	300,0	360,0	
□ U (mm)	6,0	6,0	8,0	8,0	9,0	9,0	12,0	16,0	19,0	
Nutzlänge Working length	X (mm)	262,0	325,0	324,0	424,0	442,0	542,0	—	—	—
	Y (mm)	206,0	265,0	264,0	354,0	368,0	473,0	623,0	764,0	946,0
	Z (mm)	234,0	295,0	294,0	394,0	405,0	502,5	698,0	864,0	1064,0
Gewicht je Paar Weight per pair (≈ kg)	1,120	1,300	2,970	3,500	6,100	6,500	10,650	16,200	36,100	59,500

Vorteile der Optibelt MS Motorspannschienen

- Sie sind unzerbrechlich, weil sie ganz aus Stahl hergestellt sind.
- Die genormten Motorbefestigungsschrauben sind leicht auswechselbar, z. B. bei starken Motorfüßen oder bei zu befestigenden Zusatzteilen.
- Leichtes Aufsetzen des Motors:
Nach dem Einstecken der Motorbefestigungsschrauben in die Motorfüße wird das Ganze mit den Spezialmuttern in die Stahlspannschienen eingeschoben.
- Alle Einzelteile sind bestens gegen Korrosion durch entsprechende Oberflächenbehandlung geschützt.
- Stahlspannschienen: phosphatiert und grün einbrennlackiert.
- Spannschrauben: elektro-verzinkt.
- Motorbefestigungsschrauben:
für S 71 bis S 180 elektro-verzinkt,
für S 225 bis S 355 phosphatiert und mit Rostschutz versehen.

Die mit „S“ gekennzeichneten Abmessungen (z. B. S 71) entsprechen der französischen Norm U.T.E. C-51106.

Die Zahlen 71, 100, 132, 180, 225, 280 und 355 bezeichnen die maximalen Motorachshöhen in mm für den jeweiligen Spannschienen-Typ.

Die Zahlen hinter dem Schrägstrich (6, 8, 10, 12, 16, 20, 24) geben den Gewindedurchmesser der entsprechenden Befestigungsschrauben an (6 = M6).

Die Buchstaben VS bzw. GS bezeichnen die Ausführung der Spannkloben:

VS = verschiebbarer Spannkloben

GS = geschweißter Spannkloben

Die Typen N 300, N 400 und N 600 sind nicht genormt. Es handelt sich jeweils um die verlängerte Ausführung der genormten Schiene, sodass hierfür die gleichen Ersatzteile verwendet werden können.

Ein Satz Spannschienen besteht aus 2 Schienen inklusive aller Befestigungsteile.

Advantages of Optibelt MS Motor slide rails

- Rugged all steel construction.
- The standard motor fixing bolts are easily replaced, e. g. for heavier motor feet or for the mounting of auxiliary equipment.
- Easy motor mounting. After inserting the motor mounting bolts into the motor feet, the whole unit is pushed into the rails.
- All parts are fully corrosion protected.
- The adjusting bolts are zinc plated.
- The motor mounting bolts:
for S 71 up to S 180 are zinc plated,
for S 225 up to S 355 are phosphated and rust protected.

The sizes marked with "S" (e. g. S 71) correspond to the French standard U.T.E. C-51106.

The numbers 71, 100, 132, 180, 225, 280, and 355 indicate the max. motor shaft height in mm for the individual rail types.

The numbers following the slash (6, 8, 10, 12, 16, 20, 24) indicate the thread diameters of the fixing bolts (6 = M6).

The letters VS and GS indicate the design of the adjusting screw bracket:

VS = sliding bracket

GS = fixed bracket

Slide rail part number N 300, N 400, and N 600 are not standardised. They are longer than the standard slide rails but all of the same spare parts can be used.

One set of slide rails consists of 2 rails with all fixing parts.

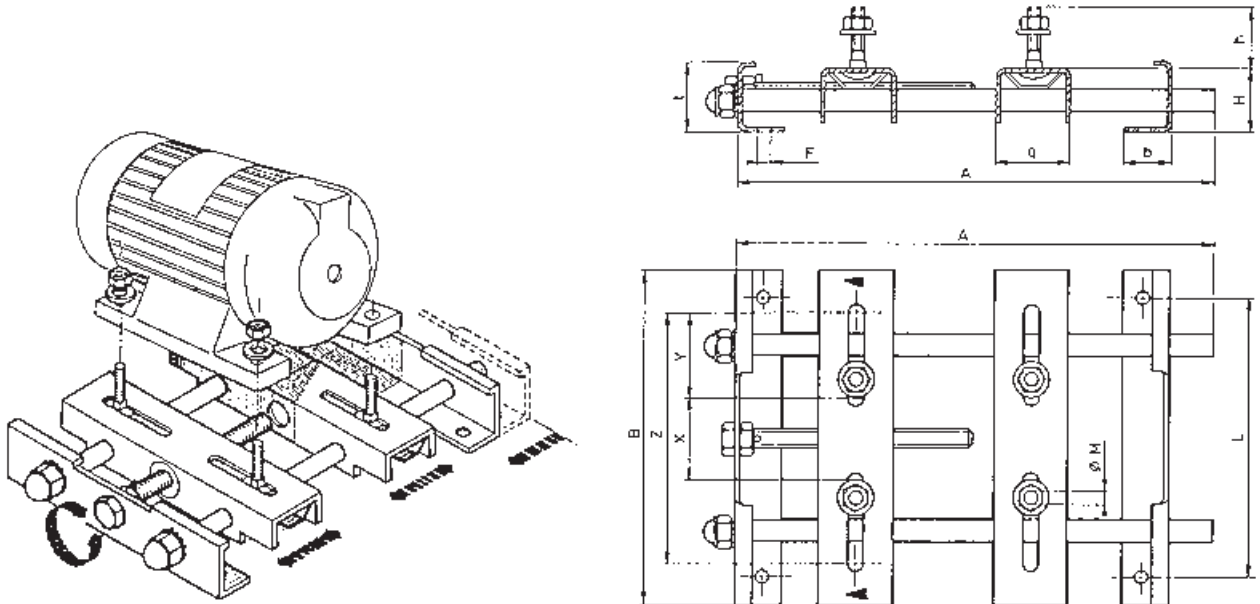

Fertigungstechnische Änderungen vorbehalten. We reserve the right to make technical changes.

Bezeichnung Part number	MS 100	MS 132
Motorachshöhe Motor shaft height Ha (mm)	100,0	132,0
A (mm)	300,0	450,0
B (mm)	180,0	265,0
F (mm)	10,0	13,0
H (mm)	35,0	50,0
L (mm)	150,0	225,0
M	M 8 x 35	M 10 x 40
b (mm)	30,0	45,0
g (mm)	40,0	55,0
h (mm)	35,0	40,0
t (mm)	40,0	55,0
u (mm)	25,0	35,0
v (mm)	20,0	25,0
w (mm)	9,0	18,0
x (mm)	46,0	105,0
y (mm)	50,0	50,0
z (mm)	145,0	204,0
Gewicht Weight (≈ kg)	2,180	4,520

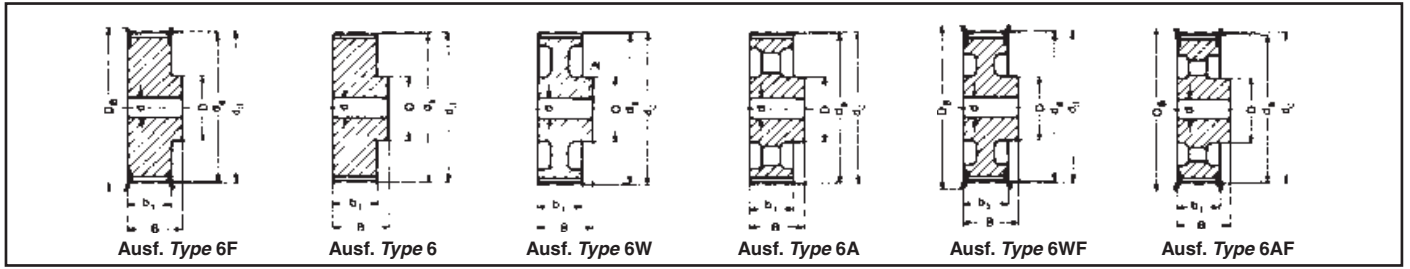

Type XL – Teilung Pitch 5,08 mm für Riemenbreite for belt width 025, 031, 037

Bezeichnung Part no.	Anzahl der Zähne No. of teeth	Aus- führung Type	Material	d _d (mm)	d _a (mm)	D _B (mm)	b ₁ (mm)	B (mm)	D (mm)	Vor- bohrung Pilot bore d (mm)	Fertig- bohrung Finished bore d _{max} (mm)	Stell- schraube Grub screw	Gewicht Weight (≈ kg)
10 XL 037	10	6F	St	16,17	15,66	23	14,3	19,8	9,5	5,0	6,4	M3	0,02
11 XL 037	11	6F	St	17,79	17,28	23	14,3	19,8	9,5	5,0	6,4	M3	0,02
12 XL 037	12	6F	St	19,40	18,89	25	14,3	19,8	12,7	5,0	7,9	M3	0,03
14 XL 037	14	6F	St	22,64	22,13	28	14,3	19,8	14,3	6,0	9,5	M4	0,04
15 XL 037	15	6F	St	24,26	23,75	28	14,3	19,8	15,9	6,0	11,1	M4	0,04
16 XL 037	16	6F	St	25,87	25,36	32	14,3	19,8	17,5	6,0	12,7	M4	0,05
18 XL 037	18	6F	St	29,11	28,60	36	14,3	19,8	19,0	6,0	14,3	M4	0,06
20 XL 037	20	6F	St	32,34	31,83	38	14,3	22,2	23,8	6,0	17,5	M4	0,08
21 XL 037	21	6F	St	33,96	33,45	38	14,3	22,2	23,8	6,0	17,5	M4	0,09
22 XL 037	22	6F	St	35,57	35,06	42	14,3	22,2	25,4	6,0	19,1	M4	0,10
24 XL 037	24	6F	St	38,81	38,30	44	14,3	22,2	27,0	6,0	20,6	M4	0,12
26 XL 037	26	6F	St	42,04	41,53	48	14,3	22,2	30,0	6,0	23,0	M4	0,14
28 XL 037	28	6F	St	45,28	44,77	51	14,3	22,2	30,2	6,0	23,0	M4	0,16
30 XL 037	30	6F	St	48,51	48,00	54	14,3	22,2	34,9	6,0	23,0	M4	0,19
32 XL 037	32	6	Al	51,74	51,23	—	14,3	25,4	38,0	8,0	23,0	M4	0,11
36 XL 037	36	6	Al	58,21	57,70	—	14,3	25,4	38,0	8,0	23,0	M4	0,13
40 XL 037	40	6	Al	64,68	64,17	—	14,3	25,4	38,0	8,0	23,0	M4	0,17
42 XL 037	42	6W	Al	67,91	67,40	—	14,3	25,4	38,0	8,0	23,0	M4	0,13
44 XL 037	44	6W	Al	71,15	70,64	—	14,3	25,4	38,0	8,0	23,0	M4	0,15
48 XL 037	48	6W	Al	77,62	77,11	—	14,3	25,4	38,0	8,0	23,0	M4	0,16
60 XL 037	60	6A	Al	97,02	96,51	—	14,3	25,4	38,0	8,0	23,0	M4	0,18
72 XL 037	72	6A	Al	116,43	115,92	—	14,3	25,4	38,0	8,0	23,0	M4	0,23

Type L – Teilung Pitch 9,525 mm für Riemenbreite for belt width 050

10 L 050	10	6F	St	30,32	29,56	36	19	26	22	6,0	13,0	—	0,11
12 L 050	12	6F	St	36,38	35,62	42	19	26	28	6,0	17,0	—	0,19
13 L 050	13	6F	St	39,41	38,65	44	19	26	30	6,0	19,0	—	0,21
14 L 050	14	6F	St	42,45	41,68	48	19	26	33	8,0	20,0	—	0,25
15 L 050	15	6F	St	45,48	44,72	51	19	26	36	8,0	23,0	—	0,30
16 L 050	16	6F	St	48,51	47,75	54	19	26	38	8,0	23,0	—	0,33
17 L 050	17	6F	St	51,54	50,78	57	19	26	40	10,0	24,0	—	0,36
18 L 050	18	6F	St	54,57	53,81	60	19	26	40	10,0	24,0	—	0,41
19 L 050	19	6F	St	57,61	56,84	60	19	26	40	10,0	24,0	—	0,45
20 L 050	20	6F	St	60,64	59,88	66	19	26	46	10,0	28,0	—	0,50
21 L 050	21	6F	St	63,67	62,91	71	19	26	46	10,0	28,0	—	0,55
22 L 050	22	6F	St	66,70	65,94	75	19	26	50	10,0	30,0	—	0,62
24 L 050	24	6F	St	72,77	72,00	79	19	26	50	12,0	30,0	—	0,68
26 L 050	26	6F	St	78,83	78,07	87	19	26	50	12,0	30,0	—	0,82
28 L 050	28	6F	St	84,89	84,13	91	19	26	50	12,0	30,0	—	0,92
30 L 050	30	6F	St	90,96	90,20	97	19	26	50	12,0	30,0	—	1,10
32 L 050	32	6F	St	97,02	96,26	103	19	26	50	12,0	30,0	—	1,20
36 L 050	36	6WF	GG	109,15	108,38	115	19	26	50	12,0	30,0	—	1,00
40 L 050	40	6WF	GG	121,28	120,51	127	19	26	50	12,0	30,0	—	1,10
44 L 050	44	6AF	GG	133,40	132,64	140	19	26	50	12,0	30,0	—	1,20
48 L 050	48	6AF	GG	145,53	144,77	152	19	26	50	12,0	30,0	—	1,30
60 L 050	60	6A	GG	181,91	181,15	—	19	28	50	15,0	30,0	—	1,30
72 L 050	72	6A	GG	218,30	217,53	—	19	28	50	15,0	30,0	—	1,70
84 L 050	84	6A	GG	254,68	253,92	—	19	28	50	15,0	30,0	—	1,90

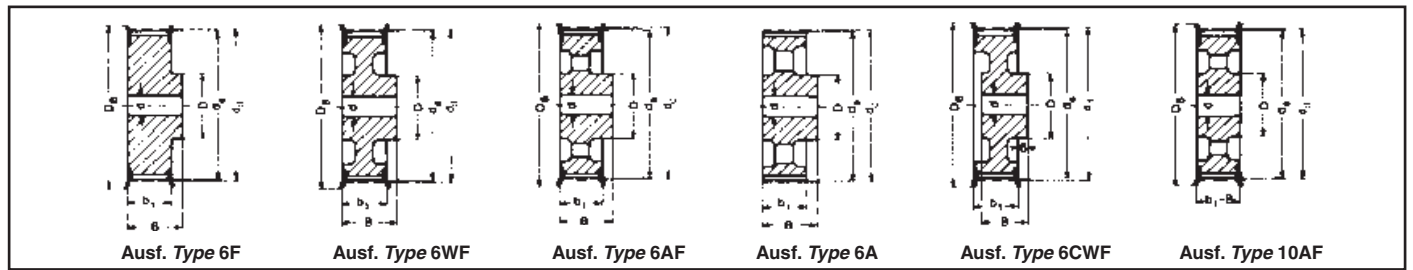

Type L – Teilung Pitch 9,525 mm für Riemenbreite for belt width 075

Bezeichnung Part no.	Anzahl der Zähne No. of teeth	Aus- führung Type	Material	d _d (mm)	d _a (mm)	D _B (mm)	b ₁ (mm)	B (mm)	D (mm)	Vor- bohrung Pilot bore d (mm)	Fertig- bohrung Finished bore d _{max} (mm)	Gewicht Weight (= kg)
10 L 075	10	6F	St	30,32	29,56	36	25	32	22	6	13	0,15
12 L 075	12	6F	St	36,38	35,62	42	25	32	28	8	17	0,23
13 L 075	13	6F	St	39,41	38,65	44	25	32	30	8	19	0,26
14 L 075	14	6F	St	42,45	41,68	48	25	32	33	8	20	0,32
15 L 075	15	6F	St	45,48	44,72	51	25	32	36	8	23	0,35
16 L 075	16	6F	St	48,51	47,75	54	25	32	38	8	23	0,42
17 L 075	17	6F	St	51,54	50,78	57	25	32	40	10	24	0,45
18 L 075	18	6F	St	54,57	53,81	60	25	32	40	10	24	0,51
19 L 075	19	6F	St	57,61	56,84	60	25	32	40	10	24	0,57
20 L 075	20	6F	St	60,64	59,88	66	25	32	46	10	28	0,63
21 L 075	21	6F	St	63,67	62,91	71	25	32	46	10	28	0,70
22 L 075	22	6F	St	66,70	65,94	75	25	32	50	10	30	0,75
24 L 075	24	6F	St	72,77	72,00	79	25	32	50	12	30	0,85
26 L 075	26	6F	St	78,83	78,07	87	25	32	50	12	30	1,00
28 L 075	28	6F	St	84,89	84,13	91	25	32	50	12	30	1,20
30 L 075	30	6F	St	90,96	90,20	97	25	32	50	12	30	1,40
32 L 075	32	6F	St	97,02	96,26	103	25	32	50	12	30	1,50
36 L 075	36	6WF	GG	109,15	108,38	115	25	32	55	12	32	1,30
40 L 075	40	6WF	GG	121,28	120,51	127	25	32	60	12	35	1,60
44 L 075	44	6AF	GG	133,40	132,64	140	25	32	60	12	35	1,70
48 L 075	48	6AF	GG	145,53	144,77	152	25	32	60	12	35	1,90
60 L 075	60	6A	GG	181,91	181,15	—	26	35	60	15	35	1,80
72 L 075	72	6A	GG	218,30	217,53	—	26	35	60	15	35	2,30
84 L 075	84	6A	GG	254,68	253,92	—	26	35	60	15	35	2,50

Type L – Teilung Pitch 9,525 mm für Riemenbreite for belt width 100

10 L 100	10	6F	St	30,32	29,56	36	31	38	22	6	13	0,81
12 L 100	12	6F	St	36,38	35,62	42	31	38	28	8	17	0,29
13 L 100	13	6F	St	39,41	38,65	44	31	38	30	8	19	0,30
14 L 100	14	6F	St	42,45	41,68	48	31	38	33	8	20	0,38
15 L 100	15	6F	St	45,48	44,72	51	31	38	36	8	23	0,40
16 L 100	16	6F	St	48,51	47,75	54	31	38	38	8	23	0,51
17 L 100	17	6F	St	51,54	50,78	57	31	38	40	10	24	0,54
18 L 100	18	6F	St	54,57	53,81	60	31	38	40	10	24	0,62
19 L 100	19	6F	St	57,61	56,84	60	31	38	40	10	24	0,69
20 L 100	20	6F	St	60,64	59,88	66	31	38	46	10	28	0,76
21 L 100	21	6F	St	63,67	62,91	71	31	38	46	10	28	0,82
22 L 100	22	6F	St	66,70	65,94	75	31	38	50	10	30	0,92
24 L 100	24	6F	St	72,77	72,00	79	31	38	50	12	30	1,10
26 L 100	26	6F	St	78,83	78,07	87	31	38	50	12	30	1,30
28 L 100	28	6F	St	84,89	84,13	91	31	38	50	12	30	1,40
30 L 100	30	6F	St	90,96	90,20	97	31	38	50	12	30	1,70
32 L 100	32	6F	St	97,02	96,26	103	31	38	50	12	30	1,80
36 L 100	36	6CWF	GG	109,15	108,38	115	32	32	55	12	32	1,50
40 L 100	40	6CWF	GG	121,28	120,51	127	32	32	60	12	35	1,80
44 L 100	44	10AF	GG	133,40	132,64	140	32	32	60	12	35	1,90
48 L 100	48	10AF	GG	145,53	144,77	152	32	32	60	12	35	2,10
60 L 100	60	6A	GG	181,91	181,15	—	32	35	60	15	35	2,00
72 L 100	72	6A	GG	218,30	217,53	—	32	35	60	15	35	2,50
84 L 100	84	6A	GG	254,68	253,92	—	32	35	60	15	35	2,70

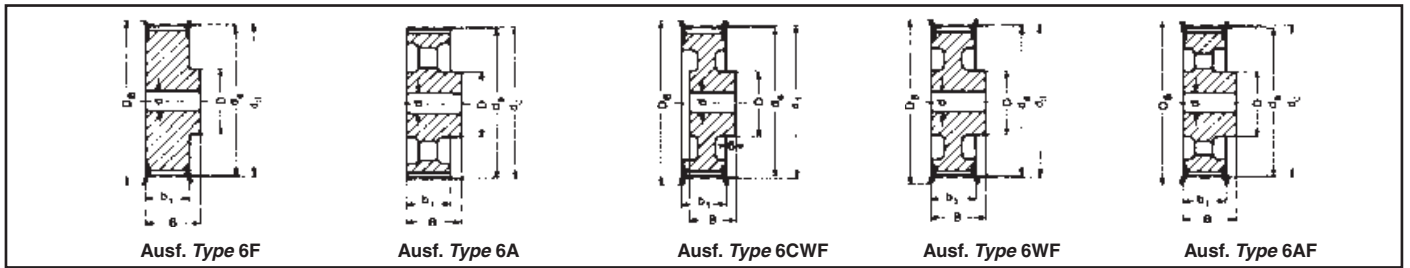

Type H – Teilung Pitch 12,7 mm für Riemenbreite for belt width 075

Bezeichnung Part no.	Anzahl der Zähne No. of teeth	Aus- führung Type	Material	d_d (mm)	d_a (mm)	D_B (mm)	b_1 (mm)	B (mm)	D (mm)	Vor- bohrung Pilot bore d (mm)	Fertig- bohrung Finished bore d_{max} (mm)	Gewicht Weight (= kg)
14 H 075	14	6F	St	56,60	55,22	64,0	26,4	40	40	10	24	0,50
16 H 075	16	6F	St	64,67	63,31	70,0	26,4	40	46	10	26	0,60
18 H 075	18	6F	St	72,77	71,39	79,0	26,4	40	54	12	32	0,80
19 H 075	19	6F	St	76,81	75,44	82,5	26,4	40	58	12	35	1,00
20 H 075	20	6F	St	80,85	79,48	87,0	26,4	40	62	12	35	1,10
21 H 075	21	6F	St	84,89	83,52	91,0	26,4	40	67	12	38	1,20
22 H 075	22	6F	St	88,94	87,56	94,0	26,4	40	70	12	38	1,40
24 H 075	24	6F	St	97,02	95,65	102,0	26,4	40	75	12	42	1,60
26 H 075	26	6F	St	105,11	103,73	112,0	26,4	40	80	15	45	1,80
28 H 075	28	6F	GG	113,19	111,82	120,0	26,4	40	80	15	45	2,00
30 H 075	30	6F	GG	121,28	119,90	128,0	26,4	40	80	15	45	2,10
32 H 075	32	6F	GG	129,36	127,99	135,0	26,4	40	70	15	45	2,20
36 H 075	36	6F	GG	145,53	144,16	152,0	26,4	40	80	20	45	2,40
40 H 075	40	6F	GG	161,70	160,33	168,0	26,4	40	80	20	45	2,80
44 H 075	44	6AF	GG	177,87	176,50	184,0	26,4	40	80	20	45	2,70
48 H 075	48	6AF	GG	194,04	192,67	200,0	26,4	40	90	20	50	3,00

Type H – Teilung Pitch 12,7 mm für Riemenbreite for belt width 100

14 H 100	14	6F	St	56,60	55,22	63	31	41	40	10	24	0,65
16 H 100	16	6F	St	64,68	63,31	71	31	41	46	10	28	0,85
18 H 100	18	6F	St	72,77	71,39	79	31	41	54	12	32	1,10
19 H 100	19	6F	St	76,81	75,44	83	31	41	58	12	34	1,20
20 H 100	20	6F	St	80,85	79,48	87	31	41	62	12	35	1,40
21 H 100	21	6F	St	84,89	83,52	91	31	41	67	12	38	1,60
22 H 100	22	6F	St	88,94	87,56	93	31	41	70	12	41	1,70
24 H 100	24	6F	St	97,02	95,65	103	31	41	75	12	45	2,00
26 H 100	26	6CWF	GG	105,11	103,73	111	32	32	55	15	32	1,40
28 H 100	28	6CWF	GG	113,19	111,82	119	32	32	60	15	35	1,60
30 H 100	30	6CWF	GG	121,28	119,90	127	32	32	60	15	35	1,70
32 H 100	32	6WF	GG	129,36	127,99	135	32	40	70	20	40	2,20
36 H 100	36	6WF	GG	145,53	144,16	152	32	40	80	20	45	3,00
40 H 100	40	6AF	GG	161,70	160,33	168	32	40	80	20	45	2,80
44 H 100	44	6AF	GG	177,87	176,50	184	32	40	80	20	45	3,10
48 H 100	48	6AF	GG	194,04	192,67	200	32	40	80	20	45	3,30
60 H 100	60	6A	GG	242,55	241,18	—	34	45	80	20	45	5,50
72 H 100	72	6A	GG	291,06	289,69	—	34	45	80	20	45	7,10
84 H 100*	84	6A	GG	339,57	338,20	—	34	45	80	20	45	8,20
96 H 100*	96	6A	GG	388,08	386,71	—	34	45	80	20	45	9,90
120 H 100*	120	6A	GG	485,10	483,73	—	34	50	90	20	50	13,10

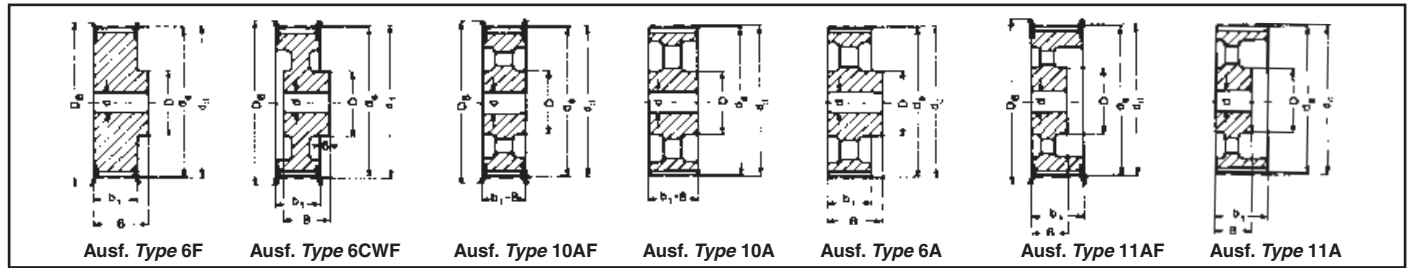

Type H – Teilung Pitch 12,7 mm für Riemenbreite for belt width 150

Bezeichnung Part no.	Anzahl der Zähne No. of teeth	Aus- führung Type	Material	d_d (mm)	d_a (mm)	D_B (mm)	b_1 (mm)	B (mm)	D (mm)	Vor- bohrung Pilot bore d (mm)	Fertig- bohrung Finished bore d_{max} (mm)	Gewicht Weight (= kg)
14 H 150	14	6F	St	56,60	55,22	63	44	54	40	12	24	0,82
16 H 150	16	6F	St	64,68	63,31	71	44	54	46	12	28	1,10
18 H 150	18	6F	St	72,77	71,39	79	44	54	54	12	32	1,50
19 H 150	19	6F	St	76,81	75,44	83	44	54	58	12	34	1,70
20 H 150	20	6F	St	80,85	79,48	87	44	54	62	12	35	1,80
21 H 150	21	6F	St	84,89	83,52	91	44	54	67	12	38	2,20
22 H 150	22	6F	St	88,94	87,56	93	44	54	70	12	41	2,30
24 H 150	24	6F	St	97,02	95,65	103	44	54	75	12	45	2,60
26 H 150	26	6CWF	GG	105,11	103,73	111	45	35	55	15	32	1,70
28 H 150	28	6CWF	GG	113,19	111,82	119	45	35	60	15	35	1,90
30 H 150	30	6CWF	GG	121,28	119,90	127	45	35	60	15	35	2,10
32 H 150	32	6CWF	GG	129,36	127,99	135	45	45	70	20	40	2,60
36 H 150	36	6CWF	GG	145,53	144,16	152	45	45	80	20	45	3,20
40 H 150	40	10AF	GG	161,70	160,33	168	45	45	80	20	45	3,80
44 H 150	44	10AF	GG	177,87	176,50	184	45	45	80	20	45	3,70
48 H 150	48	10AF	GG	194,04	192,67	200	45	45	80	20	45	4,00
60 H 150	60	10A	GG	242,55	241,18	—	46	46	85	20	48	5,10
72 H 150	72	10A	GG	291,06	289,69	—	46	46	85	20	48	7,90
84 H 150*	84	10A	GG	339,57	338,20	—	46	46	85	20	48	8,90
96 H 150*	96	10A	GG	388,08	386,71	—	46	46	85	20	48	10,10
120 H 150*	120	6A	GG	485,10	483,73	—	46	55	95	24	55	17,20

Type H – Teilung Pitch 12,7 mm für Riemenbreite for belt width 200

14 H 200	14	6F	St	56,60	55,22	63	58	68	40	12	24	1,1
16 H 200	16	6F	St	64,68	63,31	71	58	68	46	15	28	1,4
18 H 200	18	6F	St	72,77	71,39	79	58	68	54	15	32	1,8
19 H 200	19	6F	St	76,81	75,44	83	58	68	58	15	34	2,1
20 H 200	20	6F	St	80,85	79,48	87	58	68	62	15	35	2,3
21 H 200	21	6F	St	84,89	83,52	91	58	68	67	15	38	2,6
22 H 200	22	6F	St	88,94	87,56	93	58	68	70	15	41	2,8
24 H 200	24	6F	St	97,02	95,65	103	58	68	75	15	45	3,4
26 H 200	26	6CWF	GG	105,11	103,73	111	58	42	60	15	35	2,3
28 H 200	28	6CWF	GG	113,19	111,82	119	58	42	60	15	35	2,5
30 H 200	30	6CWF	GG	121,28	119,90	127	58	42	70	15	40	2,9
32 H 200	32	6CWF	GG	129,36	127,99	135	58	47	70	20	40	3,2
36 H 200	36	6CWF	GG	145,53	144,16	152	58	47	80	20	45	3,8
40 H 200	40	11AF	GG	161,70	160,33	168	58	45	80	20	45	4,1
44 H 200	44	11AF	GG	177,87	176,50	184	58	45	80	20	45	4,4
48 H 200	48	11AF	GG	194,04	192,67	200	58	45	85	20	48	5,1
60 H 200	60	11A	GG	242,55	241,18	—	60	50	90	20	50	7,1
72 H 200	72	11A	GG	291,06	289,69	—	60	50	90	20	50	8,0
84 H 200*	84	11A	GG	339,57	338,20	—	60	50	90	20	50	12,0
96 H 200*	96	11A	GG	388,08	386,71	—	60	50	90	20	50	13,6
120 H 200*	120	10A	GG	485,10	483,73	—	60	60	100	24	57	16,6

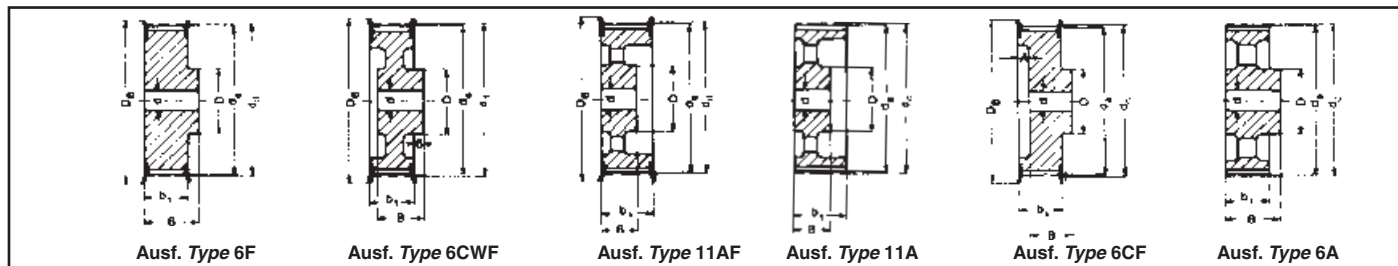

Type H – Teilung Pitch 12,7 mm für Riemenbreite for belt width 300

Bezeichnung Part no.	Anzahl der Zähne No. of teeth	Aus- führung Type	Material	d _d (mm)	d _a (mm)	D _B (mm)	b ₁ (mm)	B (mm)	D (mm)	A (mm)	Vor- bohrung Pilot bore d (mm)	Fertig- bohrung Finished bore d _{max} (mm)	Gewicht Weight (≈ kg)
16 H 300	16	6F	St	64,68	63,31	71	84	94	46	—	15	28	2,0
18 H 300	18	6F	St	72,77	71,39	79	84	94	54	—	15	32	2,6
19 H 300	19	6F	St	76,81	75,44	83	84	94	58	—	15	34	2,9
20 H 300	20	6F	St	80,85	79,48	87	84	94	62	—	15	35	3,2
21 H 300	21	6F	St	84,89	83,52	91	84	94	67	—	15	38	3,6
22 H 300	22	6F	St	88,94	87,56	93	84	94	70	—	15	41	4,0
24 H 300	24	6F	St	97,02	95,65	103	84	94	75	—	15	45	4,7
26 H 300	26	6CWF	GG	105,11	103,73	111	84	57	60	—	15	35	3,3
28 H 300	28	6CWF	GG	113,19	111,82	119	84	57	60	—	15	35	3,6
30 H 300	30	6CWF	GG	121,28	119,90	127	84	57	70	—	15	40	4,2
32 H 300	32	6CWF	GG	129,36	127,99	135	84	57	70	—	20	40	4,3
36 H 300	36	6CWF	GG	145,53	144,16	152	84	57	80	—	20	45	5,2
40 H 300	40	11AF	GG	161,70	160,33	168	84	55	80	—	20	45	5,6
44 H 300	44	11AF	GG	177,87	176,50	184	84	55	80	—	20	45	5,9
48 H 300	48	11AF	GG	194,04	192,67	200	84	55	85	—	20	48	6,6
60 H 300	60	11A	GG	242,55	241,18	—	86	55	100	—	20	57	9,9
72 H 300	72	11A	GG	291,06	289,69	—	86	55	100	—	20	57	13,0
84 H 300*	84	11A	GG	339,57	338,20	—	86	55	100	—	20	57	15,1
96 H 300*	96	11A	GG	388,08	386,71	—	86	55	100	—	20	57	18,2
120 H 300*	120	11A	GG	485,10	483,73	—	86	65	110	—	24	62	26,0

Type XH – Teilung Pitch 22,225 mm für Riemenbreite for belt width 200

18 XH 200*	18	6CF	GG	127,34	124,55	142	64,4	60	85	18	20	50	5,0
20 XH 200*	20	6CF	GG	141,49	138,69	155	64,4	60	95	18	20	55	6,0
22 XH 200*	22	6CF	GG	155,64	152,84	170	64,4	60	110	18	20	65	7,2
24 XH 200*	24	6CF	GG	169,79	166,69	184	64,4	60	125	18	25	70	8,6
26 XH 200*	26	6CF	GG	183,94	181,14	198	64,4	60	140	18	25	80	10,1
28 XH 200*	28	6CWF	GG	198,08	195,29	212	64,4	60	120	18	25	70	9,6
30 XH 200*	30	6CWF	GG	212,23	209,44	227	64,4	60	120	18	25	70	10,4
32 XH 200*	32	6CWF	GG	226,38	223,59	240	64,4	60	130	18	25	75	11,2
40 XH 200*	40	6CWF	GG	282,98	280,18	297	64,4	60	140	18	25	80	16,0
48 XH 200*	48	6A	GG	339,57	336,78	—	65,0	80	150	—	30	85	18,4
60 XH 200*	60	6A	GG	424,47	421,67	—	65,0	80	150	—	30	85	24,3
72 XH 200*	72	6A	GG	509,36	506,57	—	65,0	80	150	—	40	85	28,1
84 XH 200*	84	6A	GG	594,25	591,46	—	65,0	80	160	—	40	90	31,9
96 XH 200*	96	6A	GG	679,15	676,35	—	65,0	80	160	—	40	90	37,0

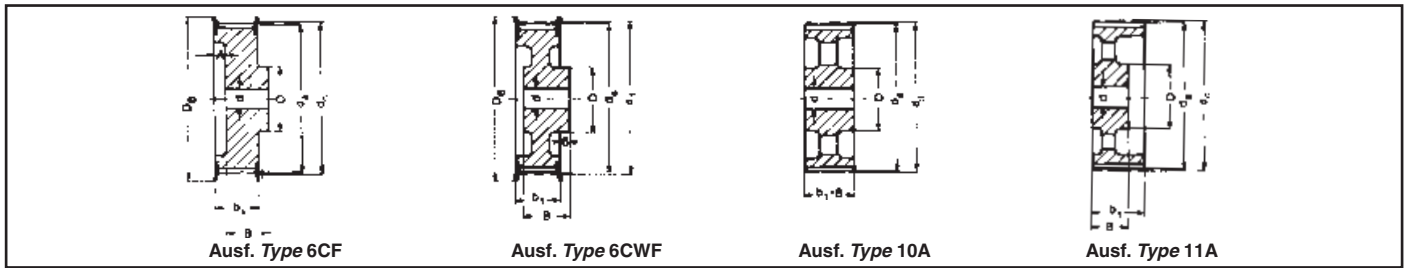

Type XH – Teilung Pitch 22,225 mm für Riemenbreite for belt width 300

Bezeichnung Part no.	Anzahl der Zähne No. of teeth	Aus- führung Type	Material	d _d (mm)	d _a (mm)	D _B (mm)	b ₁ (mm)	B (mm)	D (mm)	A (mm)	Vor- bohrung Pilot bore d (mm)	Fertig- bohrung Finished bore d _{max} (mm)	Gewicht Weight (≈ kg)
18 XH 300*	18	6CF	GG	127,34	124,55	142	91,4	70	85	35	20	50	6,8
20 XH 300*	20	6CF	GG	141,49	138,69	155	91,4	70	95	35	20	55	7,4
22 XH 300*	22	6CF	GG	155,64	152,84	170	91,4	70	110	35	20	65	9,0
24 XH 300*	24	6CF	GG	169,79	166,69	184	91,4	70	125	35	25	70	10,6
26 XH 300*	26	6CF	GG	183,94	181,14	198	91,4	70	140	35	25	80	13,0
28 XH 300*	28	6CWF	GG	198,08	195,29	212	91,4	70	120	35	25	70	12,0
30 XH 300*	30	6CWF	GG	212,23	209,44	227	91,4	70	120	35	25	70	13,0
32 XH 300*	32	6CWF	GG	226,38	223,59	240	91,4	70	130	35	25	75	14,7
40 XH 300*	40	6CWF	GG	282,98	280,18	297	91,4	70	140	35	25	80	19,9
48 XH 300*	48	10A	GG	339,57	336,78	—	92,0	92	150	—	30	85	22,5
60 XH 300*	60	10A	GG	424,47	421,67	—	92,0	92	150	—	30	85	31,5
72 XH 300*	72	10A	GG	509,36	506,57	—	92,0	92	150	—	40	85	36,4
84 XH 300*	84	10A	GG	594,25	591,46	—	92,0	92	160	—	40	90	43,4
96 XH 300*	96	10A	GG	679,15	676,35	—	92,0	92	160	—	40	90	48,5

Type XH – Teilung Pitch 22,225 mm für Riemenbreite for belt width 400

18 XH 400*	18	6CF	GG	127,34	124,55	142	118,4	85	85	47	20	50	8,5
20 XH 400*	20	6CF	GG	141,49	138,69	155	118,4	85	95	47	20	55	9,4
22 XH 400*	22	6CF	GG	155,64	152,84	170	118,4	85	110	47	20	65	11,5
24 XH 400*	24	6CF	GG	169,79	166,69	184	118,4	85	125	47	25	70	13,4
26 XH 400*	26	6CF	GG	183,94	181,14	198	118,4	85	140	47	25	80	15,6
28 XH 400*	28	6CWF	GG	198,08	195,29	212	118,4	85	120	47	25	70	14,5
30 XH 400*	30	6CWF	GG	212,23	209,44	227	118,4	85	120	47	25	70	16,0
32 XH 400*	32	6CWF	GG	226,38	223,59	240	118,4	85	130	47	25	75	18,0
40 XH 400*	40	6CWF	GG	282,98	280,18	297	118,4	85	140	47	25	80	24,0
48 XH 400*	48	11A	GG	339,57	336,78	—	119,0	92	150	—	30	85	30,8
60 XH 400*	60	11A	GG	424,47	421,67	—	119,0	92	150	—	30	85	36,2
72 XH 400*	72	11A	GG	509,36	506,57	—	119,0	92	150	—	40	85	42,7
84 XH 400*	84	11A	GG	594,25	591,46	—	119,0	92	160	—	40	90	49,7
96 XH 400*	96	11A	GG	679,15	676,35	—	119,0	92	160	—	40	90	59,9

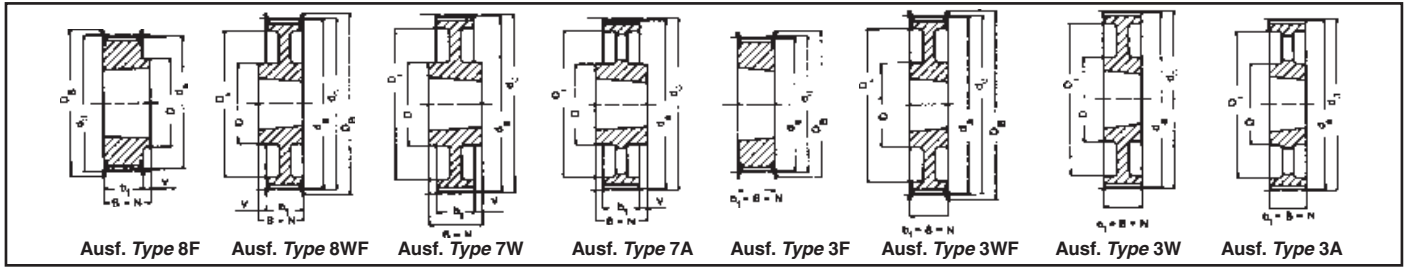

Type L – Teilung Pitch 9,525 mm für Riemenbreite for belt width 050

Bezeichnung Part no.	Anzahl der Zähne No. of teeth	Aus- führung Type	Mate- rial	d _d (mm)	d _a (mm)	D _B (mm)	b ₁ (mm)	B (mm)	N (mm)	V (mm)	Z (mm)	D (mm)	D ₁ (mm)	Taper- Buchse Taper bush	Gewicht ohne Buchse Weight without bush (= kg)
TB 18 L 050	18	8F	St	54,57	53,81	60	19,0	22,0	22,0	3,0	—	44	—	1108	0,2
TB 19 L 050	19	8F	St	57,61	56,84	60	19,0	22,0	22,0	3,0	—	44	—	1108	0,2
TB 20 L 050	20	8F	St	60,64	59,88	66	19,0	22,0	22,0	3,0	—	48	—	1108	0,2
TB 21 L 050	21	8F	St	63,67	62,91	71	19,0	22,0	22,0	3,0	—	48	—	1108	0,3
TB 22 L 050	22	8F	St	66,70	65,94	75	19,0	22,0	22,0	3,0	—	51	—	1108	0,3
TB 23 L 050	23	8F	GG	69,73	68,97	79	19,0	22,0	22,0	3,0	—	54	—	1108	0,4
TB 24 L 050	24	8F	GG	72,77	72,00	79	19,0	22,0	22,0	3,0	—	54	—	1108	0,4
TB 25 L 050	25	8F	GG	75,80	75,04	83	19,0	22,0	22,0	3,0	—	56	—	1108	0,5
TB 26 L 050	26	8F	GG	78,83	78,07	87	19,0	22,0	22,0	3,0	—	60	—	1108	0,5
TB 27 L 050	27	8F	GG	81,86	81,10	87	19,0	22,0	22,0	3,0	—	65	—	1108	0,6
TB 28 L 050	28	8F	GG	84,89	84,13	91	19,0	22,0	22,0	3,0	—	65	—	1108	0,6
TB 30 L 050	30	8F	GG	90,96	90,20	97	19,0	22,0	22,0	3,0	—	70	—	1108	0,8
TB 32 L 050	32	8F	GG	97,02	96,26	103	19,0	22,0	22,0	3,0	—	74	—	1108	0,9
TB 36 L 050	36	8F	GG	109,15	108,39	115	19,0	22,0	22,0	3,0	—	87	—	1108	1,2
TB 40 L 050	40	8F	GG	121,28	120,51	127	19,0	25,0	25,0	6,0	—	97	—	1610	1,5
TB 48 L 050	48	8WF	GG	145,53	144,77	152	19,0	25,0	25,0	6,0	—	88	124	1610	2,3
TB 60 L 050	60	7W	GG	181,91	181,15	—	19,0	25,0	25,0	3,0	—	92	166	1610	2,0
TB 72 L 050	72	7A	GG	218,30	217,53	—	19,0	25,0	25,0	3,0	—	92	202	1610	3,0
TB 84 L 050	84	7A	GG	254,68	253,90	—	19,0	25,0	25,0	3,0	—	92	236	1610	4,0
TB 96 L 050	96	7A	GG	291,06	290,30	—	19,0	32,0	32,0	6,5	—	106	270	2012	5,5
TB 120 L 050	120	7A	GG	363,83	363,07	—	19,0	32,0	32,0	6,5	—	106	343	2012	6,8

Type L – Teilung Pitch 9,525 mm für Riemenbreite for belt width 075

TB 18 L 075	18	3F	St	54,57	53,81	60	25,0	25,0	25,0	—	—	—	—	1108	0,2
TB 19 L 075	19	3F	St	57,61	56,84	60	25,0	25,0	25,0	—	—	—	—	1108	0,3
TB 20 L 075	20	3F	St	60,64	59,88	66	25,0	25,0	25,0	—	—	—	—	1108	0,3
TB 21 L 075	21	3F	St	63,67	62,91	71	25,0	25,0	25,0	—	—	—	—	1108	0,4
TB 22 L 075	22	3F	St	66,70	65,94	75	25,0	25,0	25,0	—	—	—	—	1108	0,4
TB 23 L 075	23	3F	GG	69,73	68,97	79	25,0	25,0	25,0	—	—	—	—	1108	0,4
TB 24 L 075	24	3F	GG	72,77	72,00	79	25,0	25,0	25,0	—	—	—	—	1108	0,5
TB 25 L 075	25	3F	GG	75,80	75,04	83	25,0	25,0	25,0	—	—	—	—	1108	0,6
TB 26 L 075	26	3F	GG	78,83	78,07	87	25,0	25,0	25,0	—	—	—	—	1108	0,6
TB 27 L 075	27	3F	GG	81,86	81,10	87	25,0	25,0	25,0	—	—	—	—	1108	0,7
TB 28 L 075	28	3F	GG	84,89	84,13	91	25,0	25,0	25,0	—	—	—	—	1108	0,7
TB 30 L 075	30	3F	GG	90,96	90,20	97	25,0	25,0	25,0	—	—	—	—	1108	0,9
TB 32 L 075	32	3F	GG	97,02	96,26	103	25,0	25,0	25,0	—	—	—	—	1108	1,0
TB 36 L 075	36	3F	GG	109,15	108,39	115	25,0	25,0	25,0	—	—	—	—	1610	1,2
TB 40 L 075	40	3F	GG	121,28	120,51	127	25,0	25,0	25,0	—	—	—	—	1610	1,7
TB 48 L 075	48	3WF	GG	145,53	144,77	152	25,0	25,0	25,0	—	—	92	124	1610	2,5
TB 60 L 075	60	3W	GG	181,91	181,15	—	25,0	25,0	25,0	—	—	92	166	1610	3,0
TB 72 L 075	72	3A	GG	218,30	217,53	—	25,0	25,0	25,0	—	—	92	202	1610	4,0
TB 84 L 075	84	7A	GG	254,68	253,90	—	25,0	32,0	32,0	3,5	—	106	236	2012	5,2
TB 96 L 075	96	7A	GG	291,06	290,30	—	25,0	32,0	32,0	3,5	—	106	270	2012	6,5
TB 120 L 075	120	7A	GG	363,83	363,07	—	25,0	32,0	32,0	3,5	—	106	343	2012	7,6

St = Stahl Steel
GG = Grauguss Cast iron

Fertigungstechnische Änderungen vorbehalten.
We reserve the right to make technical changes.
Bohrungsdurchmesser d₂ siehe Seite 89.
Bore diameters d₂ see page 89.

Taper-Buchse Taper bush	1108	1610	2012
Bohrung d ₂ (mm) von ... bis ... Bore d ₂ (mm) from ... to ...	10-28	14-42	14-50

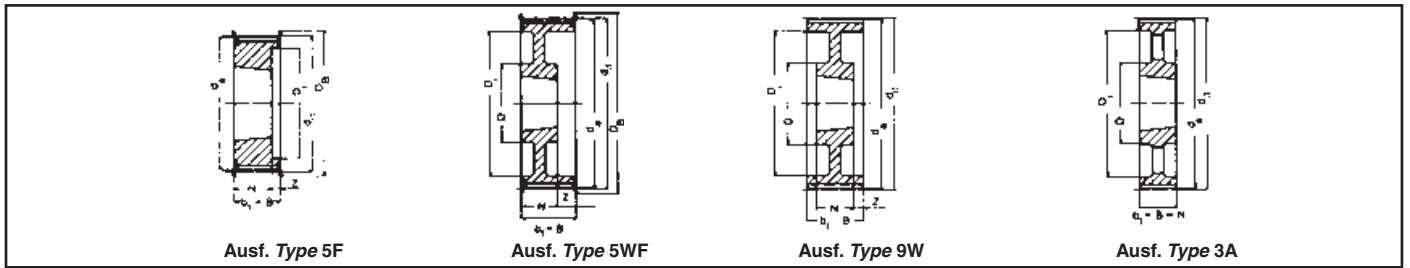

Type L – Teilung Pitch 9,525 mm für Riemenbreite for belt width 100

Bezeichnung Part no.	Anzahl der Zähne No. of teeth	Aus- führung Type	Mate- rial	d_d (mm)	d_a (mm)	D_B (mm)	b_1 (mm)	B (mm)	N (mm)	V (mm)	Z (mm)	D (mm)	D_i (mm)	Taper- Buchse Taper bush	Gewicht ohne Buchse Weight without bush (= kg)
TB 18 L 100	18	5F	St	54,57	53,81	60	31,0	31,0	22,0	—	9,0	—	38	1108	0,2
TB 19 L 100	19	5F	St	57,61	56,84	60	31,0	31,0	22,0	—	9,0	—	38	1108	0,3
TB 20 L 100	20	5F	St	60,64	59,88	66	31,0	31,0	22,0	—	9,0	—	45	1108	0,4
TB 21 L 100	21	5F	St	63,67	62,91	71	31,0	31,0	22,0	—	9,0	—	47	1108	0,4
TB 22 L 100	22	5F	St	66,70	65,94	75	31,0	31,0	22,0	—	9,0	—	51	1108	0,4
TB 23 L 100	23	5F	GG	69,73	68,97	79	32,0	32,0	22,0	—	10,0	—	54	1108	0,5
TB 24 L 100	24	5F	GG	72,77	72,00	79	32,0	32,0	22,0	—	10,0	—	54	1108	0,6
TB 25 L 100	25	5F	GG	75,80	75,04	83	32,0	32,0	22,0	—	10,0	—	56	1108	0,6
TB 26 L 100	26	5F	GG	78,83	78,07	87	32,0	32,0	22,0	—	10,0	—	60	1108	0,7
TB 27 L 100	27	5F	GG	81,86	81,10	87	32,0	32,0	22,0	—	10,0	—	62	1108	0,8
TB 28 L 100	28	5F	GG	84,89	84,13	91	32,0	32,0	22,0	—	10,0	—	65	1108	0,8
TB 30 L 100	30	5F	GG	90,96	90,20	97	32,0	32,0	25,0	—	7,0	—	71	1210	0,9
TB 32 L 100	32	5F	GG	97,02	96,26	103	32,0	32,0	25,0	—	7,0	—	75	1210	1,0
TB 36 L 100	36	5F	GG	109,15	108,39	115	32,0	32,0	25,0	—	7,0	—	89	1610	1,4
TB 40 L 100	40	5F	GG	121,28	120,51	127	32,0	32,0	25,0	—	7,0	—	101	1610	1,7
TB 48 L 100	48	5WF	GG	145,53	144,77	152	32,0	32,0	25,0	—	7,0	92	124	1610	2,7
TB 60 L 100	60	9W	GG	181,91	181,15	—	32,0	32,0	25,0	—	3,5	92	166	1610	2,4
TB 72 L 100	72	3A	GG	218,30	217,53	—	32,0	32,0	32,0	—	—	106	202	2012	4,4
TB 84 L 100	84	3A	GG	254,68	253,90	—	32,0	32,0	32,0	—	—	106	236	2012	6,0
TB 96 L 100	96	3A	GG	291,06	290,30	—	32,0	32,0	32,0	—	—	106	270	2012	7,1
TB 120 L 100	120	3A	GG	363,83	363,07	—	32,0	32,0	32,0	—	—	106	343	2012	8,5

St = Stahl Steel
GG = Grauguss Cast iron

Fertigungstechnische Änderungen vorbehalten.
We reserve the right to make technical changes.
Bohrungsdurchmesser d_2 siehe Seite 89.
Bore diameters d_2 see page 89.

Taper-Buchse Taper bush	1108	1210	1610	2012
Bohrung d_2 (mm) von ... bis ... Bore d_2 (mm) from ... to ...	10-28	11-32	14-42	14-50

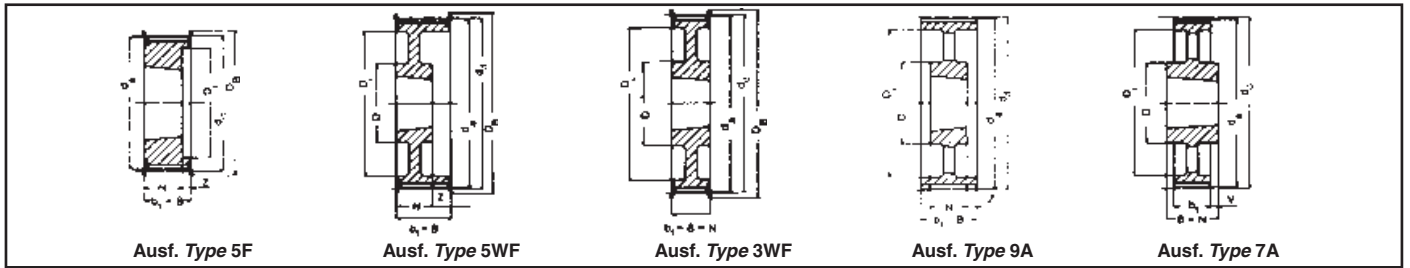

Type H – Teilung Pitch 12,7 mm für Riemenbreite for belt width 100

Bezeichnung Part no.	Anzahl der Zähne No. of teeth	Aus- führung Type	Mate- rial	d _d (mm)	d _a (mm)	D _B (mm)	b ₁ (mm)	B (mm)	N (mm)	V (mm)	Z (mm)	D (mm)	D _i (mm)	Taper- Buchse Taper bush	Gewicht ohne Buchse Weight without bush (= kg)
TB 16 H 100	16	5F	St	64,68	63,31	71	31,0	31,0	22,0	—	9,0	—	45	1108	0,4
TB 18 H 100	18	5F	St	72,77	71,39	79	31,0	31,0	25,0	—	6,0	—	52	1210	0,5
TB 19 H 100	19	5F	St	76,81	75,44	83	31,0	31,0	25,0	—	6,0	—	56	1210	0,6
TB 20 H 100	20	5F	St	80,55	79,48	87	31,0	31,0	25,0	—	6,0	—	60	1210	0,7
TB 21 H 100	21	5F	GG	84,89	83,52	91	32,0	32,0	25,0	—	7,0	—	63	1210	0,8
TB 22 H 100	22	5F	GG	88,94	87,56	93	32,0	32,0	25,0	—	7,0	—	67	1210	0,9
TB 23 H 100	23	5F	GG	92,98	91,61	97	32,0	32,0	25,0	—	7,0	—	71	1610	0,9
TB 24 H 100	24	5F	GG	97,02	95,65	103	32,0	32,0	25,0	—	7,0	—	75	1610	1,0
TB 25 H 100	25	5F	GG	101,06	99,69	106	32,0	32,0	25,0	—	7,0	—	79	1610	1,0
TB 26 H 100	26	5F	GG	105,11	103,73	111	32,0	32,0	25,0	—	7,0	—	83	1610	1,2
TB 27 H 100	27	5F	GG	109,15	107,78	115	32,0	32,0	25,0	—	7,0	—	87	1610	1,3
TB 28 H 100	28	5F	GG	113,19	111,82	119	32,0	32,0	25,0	—	7,0	—	91	1610	1,5
TB 30 H 100	30	5F	GG	121,28	119,90	127	32,0	32,0	25,0	—	7,0	—	99	1610	1,7
TB 32 H 100	32	5WF	GG	129,36	127,99	135	32,0	32,0	25,0	—	7,0	92	108	1610	2,0
TB 36 H 100	36	5WF	GG	145,53	144,16	152	32,0	32,0	25,0	—	7,0	92	124	1610	2,7
TB 40 H 100	40	5WF	GG	161,70	160,33	168	32,0	32,0	25,0	—	7,0	92	140	1610	3,6
TB 44 H 100	44	3WF	GG	177,87	176,50	184	32,0	32,0	32,0	—	—	106	153	2012	3,8
TB 48 H 100	48	3WF	GG	194,04	192,67	200	32,0	32,0	32,0	—	—	106	169	2012	3,2
TB 60 H 100	60	9A	GG	242,55	241,18	—	34,0	34,0	32,0	—	1,0	106	223	2012	4,8
TB 72 H 100	72	9A	GG	291,06	289,69	—	34,0	34,0	32,0	—	1,0	106	270	2012	5,7
TB 84 H 100*	84	9A	GG	339,57	338,20	—	34,0	34,0	32,0	—	1,0	106	318	2012	6,8
TB 96 H 100*	96	7A	GG	388,08	386,71	—	34,0	45,0	45,0	5,5	—	119	366	2517	8,2
TB 120 H 100*	120	7A	GG	485,10	483,73	—	34,0	45,0	45,0	5,5	—	119	462	2517	12,1

Type H – Teilung Pitch 12,7 mm für Riemenbreite for belt width 150

TB 18 H 150	18	5F	St	72,77	71,39	79	45,0	45,0	25,0	—	20,0	—	53	1210	0,6
TB 19 H 150	19	5F	St	76,81	75,44	83	45,0	45,0	25,0	—	20,0	—	56	1210	0,7
TB 20 H 150	20	5F	St	80,55	79,48	87	45,0	45,0	25,0	—	20,0	—	60	1210	0,8
TB 21 H 150	21	5F	GG	84,89	83,52	91	45,0	45,0	25,0	—	20,0	—	64	1210	1,0
TB 22 H 150	22	5F	GG	88,94	87,56	93	45,0	45,0	25,0	—	20,0	—	68	1210	1,2
TB 23 H 150	23	5F	GG	92,98	91,61	97	45,0	45,0	25,0	—	20,0	—	71	1610	1,3
TB 24 H 150	24	5F	GG	97,02	95,65	103	45,0	45,0	25,0	—	20,0	—	74	1610	1,2
TB 25 H 150	25	5F	GG	101,06	99,69	106	45,0	45,0	25,0	—	20,0	—	78	1610	1,2
TB 26 H 150	26	5F	GG	105,11	103,73	111	45,0	45,0	25,0	—	20,0	—	82	1610	1,4
TB 27 H 150	27	5F	GG	109,15	107,78	115	45,0	45,0	25,0	—	20,0	—	87	1610	1,6
TB 28 H 150	28	5F	GG	113,19	111,82	119	45,0	45,0	25,0	—	20,0	—	91	1610	1,8
TB 30 H 150	30	5F	GG	121,28	119,90	127	45,0	45,0	25,0	—	20,0	—	99	1610	2,0
TB 32 H 150	32	5WF	GG	129,36	127,99	135	45,0	45,0	25,0	—	20,0	92	108	1610	2,3
TB 36 H 150	36	5WF	GG	145,53	144,16	152	45,0	45,0	25,0	—	20,0	92	124	1610	3,1
TB 40 H 150	40	5WF	GG	161,70	160,33	168	45,0	45,0	25,0	—	20,0	92	140	1610	4,0
TB 44 H 150	44	5WF	GG	177,87	176,50	184	45,0	45,0	32,0	—	13,0	106	153	2012	4,4
TB 48 H 150	48	5WF	GG	194,04	192,67	200	45,0	45,0	32,0	—	13,0	106	169	2012	4,8
TB 60 H 150	60	9A	GG	242,55	241,18	—	46,0	46,0	32,0	—	7,0	106	223	2012	5,4
TB 72 H 150	72	9A	GG	291,06	289,69	—	46,0	46,0	32,0	—	7,0	106	270	2012	6,5
TB 84 H 150*	84	9A	GG	339,57	338,20	—	46,0	46,0	32,0	—	7,0	106	320	2012	8,4
TB 96 H 150*	96	9A	GG	388,08	386,71	—	46,0	46,0	45,0	—	0,5	119	366	2517	11,0
TB 120 H 150*	120	9A	GG	485,10	483,73	—	46,0	46,0	45,0	—	0,5	119	462	2517	14,8

St = Stahl Steel – GG = Grauguss Cast iron
Fertigungstechnische Änderungen vorbehalten.
We reserve the right to make technical changes.

* Keine Lagerware Non stock items

Bohrungsdurchmesser d₂ siehe Seite 89.
Bore diameters d₂ see page 89.

Taper-Buchse Taper bush	1108	1210	1610	2012	2517
Bohrung d ₂ (mm) von ... bis ... Bore d ₂ (mm) from ... to ...	10-28	11-32	14-42	14-50	16-60

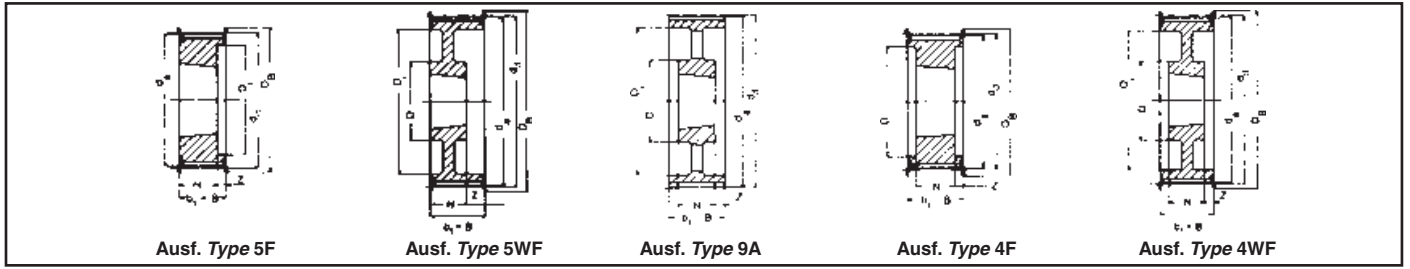

Type H – Teilung Pitch 12,7 mm für Riemenbreite for belt width 200

Bezeichnung Part no.	Anzahl der Zähne No. of teeth	Ausführung Type	Material	d _g (mm)	d _a (mm)	D _B (mm)	b ₁ (mm)	B (mm)	N (mm)	V (mm)	Z (mm)	D (mm)	D ₁ (mm)	Taper-Buchse Taper bush	Gewicht ohne Buchse Weight without bush (= kg)
TB 18 H 200	18	5F	St	72,77	71,39	79	58,0	58,0	25,0	—	33,0	—	52	1210	0,8
TB 19 H 200	19	5F	St	76,81	75,44	83	58,0	58,0	25,0	—	33,0	—	56	1610	0,9
TB 20 H 200	20	5F	St	80,55	79,48	87	58,0	58,0	25,0	—	33,0	—	60	1610	1,0
TB 21 H 200	21	5F	GG	84,89	83,52	91	58,0	58,0	25,0	—	33,0	—	64	1610	1,7
TB 22 H 200	22	5F	GG	88,94	87,56	93	58,0	58,0	25,0	—	33,0	—	68	1610	1,5
TB 23 H 200	23	5F	GG	92,98	91,61	97	58,0	58,0	25,0	—	33,0	—	71	1610	1,8
TB 24 H 200	24	5F	GG	97,02	95,65	103	58,0	58,0	25,0	—	33,0	—	74	1610	1,5
TB 25 H 200	25	5F	GG	101,06	99,69	106	58,0	58,0	25,0	—	33,0	—	78	1610	1,5
TB 26 H 200	26	5F	GG	105,11	103,73	111	58,0	58,0	25,0	—	33,0	—	82	1610	1,8
TB 27 H 200	27	5F	GG	109,15	107,78	115	58,0	58,0	25,0	—	33,0	—	87	1610	1,9
TB 28 H 200	28	5F	GG	113,19	111,82	119	58,0	58,0	25,0	—	33,0	—	91	1610	1,9
TB 30 H 200	30	5F	GG	121,28	119,90	127	58,0	58,0	25,0	—	33,0	—	99	1610	2,3
TB 32 H 200	32	5F	GG	129,36	127,99	135	58,0	58,0	32,0	—	26,0	—	107	2012	3,0
TB 36 H 200	36	5WF	GG	145,53	144,16	152	58,0	58,0	32,0	—	26,0	102	124	2012	3,0
TB 40 H 200	40	5WF	GG	161,70	160,33	168	58,0	58,0	32,0	—	26,0	106	140	2012	3,6
TB 44 H 200	44	5WF	GG	177,87	176,50	184	58,0	58,0	32,0	—	26,0	106	153	2012	4,5
TB 48 H 200	48	5WF	GG	194,04	192,67	200	58,0	58,0	45,0	—	13,0	119	169	2517	4,6
TB 60 H 200	60	9A	GG	242,55	241,18	—	60,0	60,0	45,0	—	7,5	119	223	2517	7,0
TB 72 H 200	72	9A	GG	291,06	289,69	—	60,0	60,0	45,0	—	7,5	119	270	2517	8,0
TB 84 H 200*	84	9A	GG	339,57	338,20	—	60,0	60,0	45,0	—	7,5	119	320	2517	9,0
TB 96 H 200*	96	9A	GG	388,08	386,71	—	60,0	60,0	45,0	—	7,5	119	366	2517	11,5
TB 120 H 200*	120	9A	GG	485,10	483,73	—	60,0	60,0	45,0	—	7,5	119	462	2517	15,4

Type H – Teilung Pitch 12,7 mm für Riemenbreite for belt width 300

TB 20 H 300	20	4F	St	80,55	79,48	87	84,0	84,0	38,0	—	23,0	—	65	1615	1,5
TB 21 H 300	21	4F	GG	84,89	83,52	91	84,0	84,0	38,0	—	23,0	—	66	1615	1,2
TB 22 H 300	22	4F	GG	88,94	87,56	93	84,0	84,0	38,0	—	23,0	—	67	1615	1,6
TB 23 H 300	23	4F	GG	92,98	91,61	97	84,0	84,0	38,0	—	23,0	—	71	1615	1,8
TB 24 H 300	24	4F	GG	97,02	95,65	103	84,0	84,0	38,0	—	23,0	—	75	1615	2,1
TB 25 H 300	25	4F	GG	101,06	99,69	106	84,0	84,0	38,0	—	23,0	—	79	1615	2,0
TB 26 H 300	26	4F	GG	105,11	103,73	111	84,0	84,0	38,0	—	23,0	—	83	1615	2,7
TB 27 H 300	27	4F	GG	109,15	107,78	115	84,0	84,0	32,0	—	26,0	—	87	2012	3,0
TB 28 H 300	28	4F	GG	113,19	111,82	119	84,0	84,0	32,0	—	26,0	—	91	2012	2,4
TB 30 H 300	30	4F	GG	121,28	119,90	127	84,0	84,0	32,0	—	26,0	—	99	2012	2,9
TB 32 H 300	32	4F	GG	129,36	127,99	135	84,0	84,0	45,0	—	19,5	—	107	2517	3,3
TB 36 H 300	36	4F	GG	145,53	144,16	152	84,0	84,0	45,0	—	19,5	—	124	2517	4,5
TB 40 H 300	40	4F	GG	161,70	160,33	168	84,0	84,0	45,0	—	19,5	—	137	2517	6,0
TB 44 H 300	44	4WF	GG	177,87	176,50	184	86,0	86,0	45,0	—	20,5	119	153	2517	6,6
TB 48 H 300	48	4WF	GG	194,04	192,67	200	86,0	86,0	45,0	—	20,5	119	169	2517	7,6
TB 60 H 300	60	9A	GG	242,55	241,18	—	86,0	86,0	45,0	—	20,5	119	223	2517	8,4
TB 72 H 300	72	9A	GG	291,06	289,69	—	86,0	86,0	45,0	—	20,5	119	270	2517	10,4
TB 84 H 300*	84	9A	GG	339,57	338,20	—	86,0	86,0	45,0	—	20,5	119	320	2517	12,5
TB 96 H 300*	96	9A	GG	388,08	386,71	—	86,0	86,0	76,0	—	5,0	150	362	3030	14,2
TB 120 H 300*	120	9A	GG	485,10	483,73	—	86,0	86,0	76,0	—	5,0	150	460	3030	18,8

St = Stahl Steel – GG = Grauguss Cast iron
Fertigungstechnische Änderungen vorbehalten.
We reserve the right to make technical changes.
* Keine Lagerware Non stock items
Bohrungsdurchmesser d₂ siehe Seite 89.
Bore diameters d₂ see page 89.

Taper-Buchse Taper bush	1210	1610	1615	2012	2517	3030
Bohrung d ₂ (mm) von ... bis ... Bore d ₂ (mm) from ... to ...	11-32	14-42	14-42	14-50	16-60	35-75

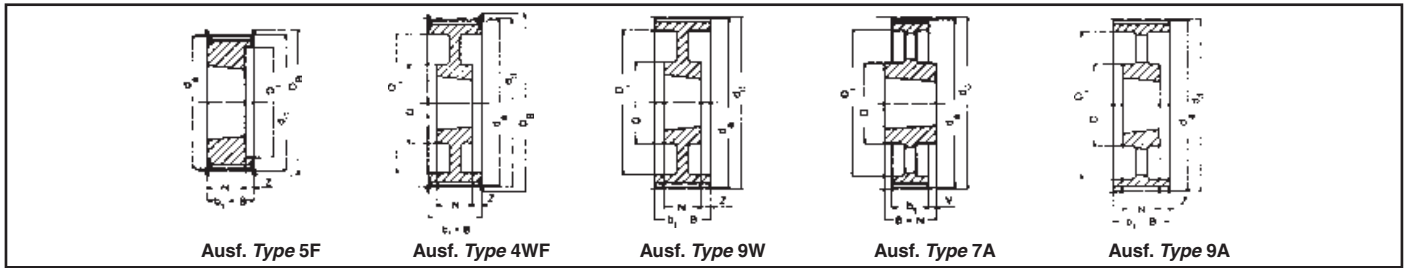

Type XH – Teilung Pitch 22,225 mm für Riemenbreite for belt width 200

Bezeichnung Part no.	Anzahl der Zähne No. of teeth	Aus- führung Type	Mate- rial	d_d (mm)	d_a (mm)	D_B (mm)	b_1 (mm)	B (mm)	N (mm)	V (mm)	Z (mm)	D (mm)	D_i (mm)	Taper- Buchse Taper bush	Gewicht ohne Buchse Weight without bush (= kg)
TB 18 XH 200*	18	5F	GG	127,34	124,55	138	64	64	45	—	20,0	—	95	2517	2,6
TB 20 XH 200*	20	5F	GG	141,49	138,69	154	64	64	45	—	20,0	—	110	2517	3,6
TB 22 XH 200*	22	5F	GG	155,64	152,84	168	64	64	45	—	20,0	—	120	2517	4,8
TB 24 XH 200*	24	5F	GG	169,79	166,69	183	64	64	45	—	20,0	—	135	2517	6,1
TB 26 XH 200*	26	5F	GG	183,94	181,14	198	64	64	45	—	20,0	—	150	2517	7,4
TB 28 XH 200*	28	4WF	GG	198,08	195,29	211	64	64	45	—	10,0	120	165	2517	9,0
TB 30 XH 200*	30	4WF	GG	212,23	209,44	226	64	64	45	—	10,0	120	180	2517	8,6
TB 32 XH 200*	32	4WF	GG	226,38	223,59	240	64	64	45	—	10,0	120	195	2517	9,8
TB 40 XH 200*	40	4WF	GG	282,98	280,18	296	64	64	51	—	6,5	160	245	3020	13,3
TB 48 XH 200*	48	9W	GG	339,57	336,78	—	64	64	51	—	6,5	160	300	3020	19,0

Type XH – Teilung Pitch 22,225 mm für Riemenbreite for belt width 300

TB 18 XH 300*	18	5F	GG	127,34	124,55	138	90	90	45	—	45,0	—	95	2517	3,7
TB 20 XH 300*	20	5F	GG	141,49	138,69	154	90	90	45	—	45,0	—	110	2517	4,7
TB 22 XH 300*	22	5F	GG	155,64	152,84	168	90	90	45	—	45,0	—	120	2517	6,0
TB 24 XH 300*	24	5F	GG	169,79	166,69	183	90	90	45	—	45,0	—	135	2517	7,6
TB 26 XH 300*	26	5F	GG	183,94	181,14	198	90	90	45	—	45,0	—	150	2517	9,8
TB 28 XH 300*	28	5F	GG	198,08	195,29	211	90	90	51	—	39,0	—	165	3020	11,6
TB 30 XH 300*	30	5F	GG	212,23	209,44	226	90	90	51	—	39,0	—	180	3020	11,9
TB 32 XH 300*	32	5F	GG	226,38	223,59	240	90	90	51	—	39,0	—	195	3020	13,8
TB 40 XH 300*	40	4WF	GG	282,98	280,18	296	90	90	51	—	19,5	160	245	3020	19,5
TB 48 XH 300*	48	9W	GG	339,57	336,78	—	90	90	51	—	19,5	160	300	3020	27,0

GG = Grauguss Cast iron

Fertigungstechnische Änderungen vorbehalten.
We reserve the right to make technical changes.

* Keine Lagerware Non stock items

Bohrungsdurchmesser d_2 siehe Seite 89.
Bore diameters d_2 see page 89.

Taper-Buchse Taper bush	2517	3020	3535	4040
Bohrung d_2 (mm) von ... bis ... Bore d_2 (mm) from ... to ...	16-60	25-75	35-90	40-100

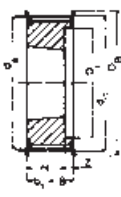

Ausf. Type 5F

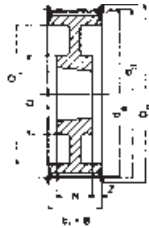

Ausf. Type 4WF

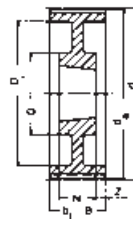

Ausf. Type 9W

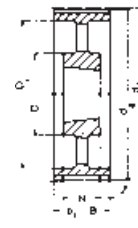

Ausf. Type 9A

Type XH – Teilung Pitch 22,225 mm für Riemenbreite for belt width 400

Bezeichnung Part no.	Anzahl der Zähne No. of teeth	Aus- führung Type	Mate- rial	d_g (mm)	d_a (mm)	D_B (mm)	b_1 (mm)	B (mm)	N (mm)	V (mm)	Z (mm)	D (mm)	D_1 (mm)	Taper- Buchse Taper bush	Gewicht ohne Buchse Weight without bush (= kg)
TB 20 XH 400*	20	5F	GG	141,49	138,69	154	119	119	45	—	74,0	—	110	2517	6,0
TB 22 XH 400*	22	5F	GG	155,64	152,84	168	119	119	45	—	74,0	—	120	2517	7,2
TB 24 XH 400*	24	5F	GG	169,79	166,69	183	119	119	51	—	68,0	—	135	3020	8,4
TB 26 XH 400*	26	5F	GG	183,94	181,14	198	119	119	51	—	68,0	—	150	3020	10,3
TB 28 XH 400*	28	5F	GG	198,08	195,29	211	119	119	51	—	68,0	—	165	3020	12,3
TB 30 XH 400*	30	5F	GG	212,23	209,44	226	119	119	51	—	68,0	—	180	3020	14,3
TB 32 XH 400*	32	5F	GG	226,38	223,59	240	119	119	51	—	68,0	—	195	3020	19,9
TB 40 XH 400*	40	4WF	GG	282,98	280,18	296	119	119	89	—	15,0	190	245	3535	24,6
TB 48 XH 400*	48	9W	GG	339,57	336,78	—	119	119	89	—	15,0	190	300	3535	30,0

GG = Grauguss Cast iron

Fertigungstechnische Änderungen vorbehalten.
We reserve the right to make technical changes.

* Keine Lagerware Non stock items

Bohrungsdurchmesser d_2 siehe Seite 89.
Bore diameters d_2 see page 89.

Taper-Buchse Taper bush	2517	3020	3535	4040
Bohrung d_2 (mm) von ... bis ... Bore d_2 (mm) from ... to ...	16-60	25-75	35-90	40-100

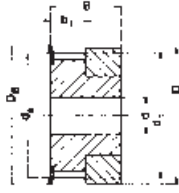

Ausf. Type 1F

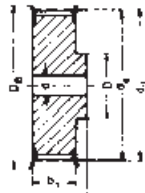

Ausf. Type 6F



Ausf. Type 6

Type 3M – Teilung Pitch 3 mm für Riemenbreite for belt width 6 mm **Keine Lagerware
Non stock items**

Bezeichnung Part no.	Anzahl der Zähne No. of teeth	Aus- führung Type	Material	d _g (mm)	d _a (mm)	D _B (mm)	b ₁ (mm)	B (mm)	D (mm)	Vor- bohrung Pilot bore d (mm)	Fertig- bohrung Finished bore d _{max} (mm)	Gewicht Weight (= kg)
10-3M-6	10	1F	Al	9,55	8,79	13,0	7,2	14,5	13,0	—	3	
12-3M-6	12	1F	Al	11,46	10,70	15,0	7,2	14,5	15,0	—	5	
14-3M-6	14	1F	Al	13,37	12,61	16,0	7,2	14,5	16,0	—	6	
15-3M-6	15	1F	Al	14,32	13,56	17,5	7,2	14,5	17,5	—	6	
16-3M-6	16	6F	Al	15,28	14,52	18,0	9,8	17,5	10,0	4	7	
18-3M-6	18	6F	Al	17,19	16,43	19,5	9,8	17,5	11,0	6	8	
20-3M-6	20	6F	Al	19,10	18,34	23,0	9,8	17,5	13,0	6	9	
21-3M-6	21	6F	Al	20,05	19,29	25,0	9,8	17,5	14,0	6	9	
22-3M-6	22	6F	Al	21,01	20,25	25,0	9,8	17,5	14,0	6	9	
24-3M-6	24	6F	Al	22,92	22,16	25,0	9,8	17,5	14,0	6	9	
26-3M-6	26	6F	Al	24,83	24,07	28,0	9,8	17,5	16,0	6	11	
28-3M-6	28	6F	Al	26,74	25,98	32,0	9,8	17,5	18,0	6	12	
30-3M-6	30	6F	Al	28,65	27,89	32,0	9,8	17,5	20,0	6	14	
32-3M-6	32	6F	Al	30,56	29,80	36,0	9,8	17,5	22,0	6	15	
36-3M-6	36	6F	Al	34,38	33,62	38,0	10,3	18,0	26,0	6	16	
40-3M-6	40	6F	Al	38,20	37,44	42,0	10,3	18,0	28,0	6	18	
44-3M-6	44	6F	Al	42,02	41,26	48,0	10,3	18,0	33,0	6	20	
48-3M-6	48	6	Al	45,84	45,08	—	10,3	18,6	33,0	8	20	
60-3M-6	60	6	Al	57,30	56,54	—	10,3	18,6	33,0	8	20	
72-3M-6	72	6	Al	68,75	67,99	—	10,3	18,6	33,0	8	20	

Type 3M – Teilung Pitch 3 mm für Riemenbreite for belt width 9 mm

10-3M-9	10	1F	Al	9,55	8,79	13,0	10,2	17,5	13,0	—	3	0,004
12-3M-9	12	1F	Al	11,46	10,70	15,0	10,2	17,5	15,0	—	5	0,006
14-3M-9	14	1F	Al	13,37	12,61	16,0	10,2	17,5	16,0	—	6	0,007
15-3M-9	15	1F	Al	14,32	13,56	17,5	10,2	17,5	17,5	—	6	0,008
16-3M-9	16	6F	Al	15,28	14,52	18,0	12,8	20,6	10,0	4	7	0,007
18-3M-9	18	6F	Al	17,19	16,43	19,5	12,8	20,6	11,0	6	8	0,008
20-3M-9	20	6F	Al	19,10	18,34	23,0	12,8	20,6	13,0	6	9	0,010
21-3M-9	21	6F	Al	20,05	19,29	25,0	12,8	20,6	14,0	6	9	0,013
22-3M-9	22	6F	Al	21,01	20,25	25,0	12,8	20,6	14,0	6	9	0,014
24-3M-9	24	6F	Al	22,92	22,16	25,0	12,8	20,6	14,0	6	9	0,016
26-3M-9	26	6F	Al	24,83	24,07	28,0	12,8	20,6	16,0	6	11	0,018
28-3M-9	28	6F	Al	26,74	25,98	32,0	12,8	20,6	18,0	6	12	0,024
30-3M-9	30	6F	Al	28,65	27,89	32,0	12,8	20,6	20,0	6	14	0,028
32-3M-9	32	6F	Al	30,56	29,80	36,0	12,8	20,6	22,0	6	15	0,032
36-3M-9	36	6F	Al	34,38	33,62	38,0	13,4	22,2	26,0	6	16	0,045
40-3M-9	40	6F	Al	38,20	37,44	42,0	13,4	22,2	28,0	6	18	0,055
44-3M-9	44	6F	Al	42,02	41,26	48,0	13,4	22,2	33,0	6	20	0,074
48-3M-9	48	6	Al	45,84	45,08	—	13,4	22,2	33,0	8	20	0,074
60-3M-9	60	6	Al	57,30	56,54	—	13,4	22,2	33,0	8	20	0,106
72-3M-9	72	6	Al	68,75	67,99	—	13,4	22,2	33,0	8	20	0,145

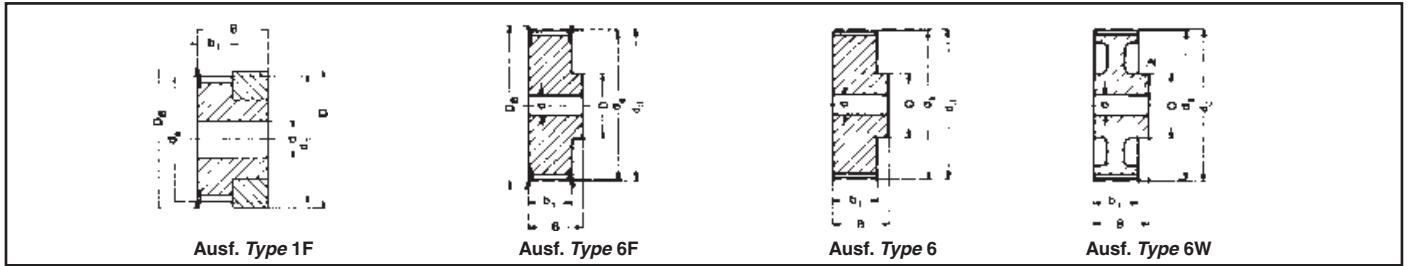

Type 3M – Teilung Pitch 3 mm für Riemenbreite for belt width 15 mm

Bezeichnung Part no.	Anzahl der Zähne No. of teeth	Aus- führung Type	Material	d _d (mm)	d _a (mm)	D _B (mm)	b ₁ (mm)	B (mm)	D (mm)	Vor- bohrung Pilot bore d (mm)	Fertig- bohrung Finished bore d _{max} (mm)	Gewicht Weight (= kg)
10-3M-15	10	1F	Al	9,55	8,79	13,0	17,0	26	13,0	—	3	0,006
12-3M-15	12	1F	Al	11,46	10,70	15,0	17,0	26	15,0	—	5	0,008
14-3M-15	14	1F	Al	13,37	12,61	16,0	17,0	26	16,0	—	6	0,010
15-3M-15	15	1F	Al	14,32	13,56	17,5	17,0	26	17,5	—	6	0,012
16-3M-15	16	6F	Al	15,28	14,52	18,0	19,5	26	10,0	4	7	0,010
18-3M-15	18	6F	Al	17,19	16,43	19,5	19,5	26	11,0	6	8	0,012
20-3M-15	20	6F	Al	19,10	18,34	23,0	19,5	26	13,0	6	9	0,014
21-3M-15	21	6F	Al	20,05	19,29	25,0	19,5	26	14,0	6	9	0,016
22-3M-15	22	6F	Al	21,01	20,25	25,0	19,5	26	14,0	6	9	0,018
24-3M-15	24	6F	Al	22,92	22,16	25,0	19,5	26	14,0	6	9	0,020
26-3M-15	26	6F	Al	24,83	24,07	28,0	19,5	26	16,0	6	11	0,027
28-3M-15	28	6F	Al	26,74	25,98	32,0	19,5	26	18,0	6	12	0,030
30-3M-15	30	6F	Al	28,65	27,89	32,0	19,5	26	20,0	6	14	0,035
32-3M-15	32	6F	Al	30,56	29,80	36,0	19,5	26	22,0	6	15	0,042
36-3M-15	36	6F	Al	34,38	33,62	38,0	20,0	30	26,0	6	16	0,060
40-3M-15	40	6F	Al	38,20	37,44	42,0	20,0	30	28,0	6	18	0,075
44-3M-15	44	6F	Al	42,02	41,26	48,0	20,0	30	33,0	6	20	0,100
48-3M-15	48	6	Al	45,84	45,08	—	20,0	30	33,0	8	20	0,103
60-3M-15	60	6	Al	57,30	56,54	—	20,0	30	33,0	8	20	0,150
72-3M-15	72	6	Al	68,75	67,99	—	20,0	30	33,0	8	20	0,212

Type 5M – Teilung Pitch 5 mm für Riemenbreite for belt width 9 mm

12-5M-9	12	6F	St	19,10	17,96	23	14,5	20,0	13,0	4	7	0,028
14-5M-9	14	6F	St	22,28	21,14	25	14,5	20,0	14,0	6	8	0,034
15-5M-9	15	6F	St	23,87	22,73	28	14,5	20,0	16,0	6	10	0,042
16-5M-9	16	6F	St	25,46	24,32	28	14,5	20,0	16,5	6	10	0,050
18-5M-9	18	6F	St	28,65	27,51	32	14,5	20,0	20,0	6	12	0,070
20-5M-9	20	6F	St	31,83	30,69	36	14,5	22,5	23,0	6	14	0,094
21-5M-9	21	6F	St	33,42	32,28	38	14,5	22,5	24,0	6	14	0,110
22-5M-9	22	6F	St	35,01	33,87	38	14,5	22,5	25,5	6	14	0,118
24-5M-9	24	6F	St	38,20	37,06	42	14,5	22,5	27,0	6	16	0,145
26-5M-9	26	6F	St	41,38	40,24	44	14,5	22,5	30,0	6	18	0,170
28-5M-9	28	6F	St	44,56	43,42	48	14,5	22,5	30,5	6	18	0,200
30-5M-9	30	6F	St	47,75	46,61	51	14,5	22,5	35,0	6	20	0,236
32-5M-9	32	6F	St	50,93	49,79	54	14,5	22,5	38,0	8	22	0,270
36-5M-9	36	6F	St	57,30	56,16	60	14,5	22,5	38,0	8	22	0,324
40-5M-9	40	6F	St	63,66	62,52	71	14,5	22,5	38,0	8	22	0,400
44-5M-9	44	6W	Al	70,03	68,89	—	14,5	25,5	38,0	8	22	0,170
48-5M-9	48	6W	Al	76,39	75,25	—	14,5	25,5	45,0	8	25	0,182
60-5M-9	60	6W	Al	95,49	94,35	—	14,5	25,5	45,0	8	25	0,230
72-5M-9	72	6W	Al	114,59	113,45	—	14,5	25,5	45,0	8	25	0,270

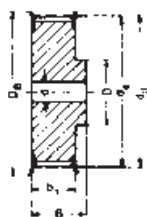

Ausf. Type 6F



Ausf. Type 6W

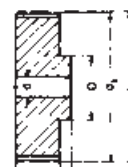

Ausf. Type 6

Type 5M – Teilung Pitch 5 mm für Riemenbreite for belt width 15 mm

Bezeichnung Part no.	Anzahl der Zähne No. of teeth	Aus- führung Type	Material	d _b (mm)	d _a (mm)	D _B (mm)	b ₁ (mm)	B (mm)	D (mm)	Vor- bohrung Pilot bore d (mm)	Fertig- bohrung Finished bore d _{max} (mm)	Gewicht Weight (= kg)
12-5M-15	12	6F	St	19,10	17,96	25	20,5	26	13,0	4	7	0,034
14-5M-15	14	6F	St	22,28	21,14	25	20,5	26	14,0	6	8	0,046
15-5M-15	15	6F	St	23,87	22,73	28	20,5	26	16,0	6	10	0,056
16-5M-15	16	6F	St	25,46	24,32	28	20,5	26	16,5	6	10	0,064
18-5M-15	18	6F	St	28,65	27,51	32	20,5	26	20,0	6	12	0,086
20-5M-15	20	6F	St	31,83	30,69	36	20,5	26	23,0	6	14	0,112
21-5M-15	21	6F	St	33,42	32,28	38	20,5	26	24,0	6	14	0,130
22-5M-15	22	6F	St	35,01	33,87	38	20,5	26	25,5	6	14	0,140
24-5M-15	24	6F	St	38,20	37,06	42	20,5	28	27,0	6	16	0,180
26-5M-15	26	6F	St	41,38	40,24	44	20,5	28	30,0	6	18	0,220
28-5M-15	28	6F	St	44,56	43,42	48	20,5	28	30,5	6	18	0,250
30-5M-15	30	6F	St	47,75	46,61	51	20,5	28	35,0	6	20	0,300
32-5M-15	32	6F	St	50,93	49,79	54	20,5	28	38,0	8	22	0,350
36-5M-15	36	6F	St	57,30	56,16	60	20,5	28	38,0	8	22	0,426
40-5M-15	40	6F	St	63,66	62,52	71	20,5	28	38,0	8	22	0,520
44-5M-15	44	6W	Al	70,03	68,89	—	20,5	30	38,0	8	22	0,225
48-5M-15	48	6W	Al	76,39	75,25	—	20,5	30	38,0	8	25	0,187
60-5M-15	60	6W	Al	95,49	94,35	—	20,5	30	50,0	8	25	0,305
72-5M-15	72	6W	Al	114,59	113,45	—	20,5	30	50,0	8	25	0,375

Type 5M – Teilung Pitch 5 mm für Riemenbreite for belt width 25 mm

12-5M-25	12	6F	St	19,10	17,96	25	30	36	13,0	4	7	0,050
14-5M-25	14	6F	St	22,28	21,14	25	30	36	14,0	6	8	0,070
15-5M-25	15	6F	St	23,87	22,73	28	30	36	16,0	6	10	0,080
16-5M-25	16	6F	St	25,46	24,32	28	30	36	16,5	6	10	0,100
18-5M-25	18	6F	St	28,65	27,51	32	30	36	20,0	6	12	0,120
20-5M-25	20	6F	St	31,83	30,69	36	30	36	23,0	6	14	0,160
21-5M-25	21	6F	St	33,42	32,28	38	30	38	24,0	6	14	0,190
22-5M-25	22	6F	St	35,01	33,87	38	30	38	25,5	6	14	0,210
24-5M-25	24	6F	St	38,20	37,06	42	30	38	27,0	6	16	0,250
26-5M-25	26	6F	St	41,38	40,24	44	30	38	30,0	6	18	0,300
28-5M-25	28	6F	St	44,56	43,42	48	30	38	30,5	6	18	0,350
30-5M-25	30	6F	St	47,75	46,61	51	30	38	35,0	6	20	0,420
32-5M-25	32	6F	St	50,93	49,79	54	30	38	38,0	8	22	0,480
36-5M-25	36	6F	St	57,30	56,16	60	30	38	38,0	8	22	0,590
40-5M-25	40	6F	St	63,66	62,52	71	30	38	38,0	8	22	0,740
44-5M-25	44	6W	Al	70,03	68,89	—	30	40	38,0	8	22	0,320
48-5M-25	48	6W	Al	76,39	75,25	—	30	40	38,0	8	25	0,275
60-5M-25	60	6W	Al	95,49	94,35	—	30	40	50,0	8	25	0,435
72-5M-25	72	6W	Al	114,59	113,45	—	30	40	50,0	8	25	0,525

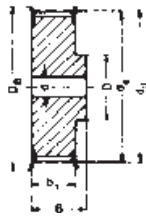

Ausf. Type 6F

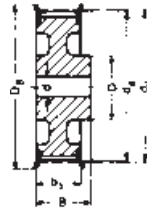

Ausf. Type 6WF

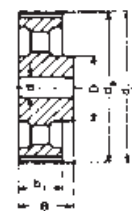

Ausf. Type 6A

Type 8M – Teilung Pitch 8 mm für Riemenbreite for belt width 20 mm

Bezeichnung Part no.	Anzahl der Zähne No. of teeth	Aus- führung Type	Material	d _d (mm)	d _a (mm)	D _B (mm)	b ₁ (mm)	B (mm)	D (mm)	D _i (mm)	Vor- bohrung Pilot bore d (mm)	Fertig- bohrung Finished bore d _{max} (mm)	Gewicht Weight (≈ kg)
22-8M-20	22	6F	St	56,02	54,65	60,0	28	38	43	—	12	30	0,54
24-8M-20	24	6F	St	61,12	59,75	66,0	28	38	45	—	12	30	0,65
26-8M-20	26	6F	St	66,21	64,84	71,0	28	38	50	—	12	35	0,80
28-8M-20	28	6F	St	71,30	70,08	75,0	28	38	50	—	15	35	0,87
30-8M-20	30	6F	St	76,39	75,13	83,0	28	38	55	—	15	35	1,02
32-8M-20	32	6F	St	81,49	80,16	87,0	28	38	60	—	15	40	1,20
34-8M-20	34	6F	St	86,58	85,22	91,0	28	38	70	—	15	45	1,40
36-8M-20	36	6F	St	91,67	90,30	98,5	28	38	70	—	15	45	1,55
38-8M-20	38	6F	St	96,77	95,39	103,0	28	38	75	—	15	45	1,65
40-8M-20	40	6F	GG	101,86	100,49	106,0	28	38	75	—	15	45	1,80
44-8M-20	44	6F	GG	112,05	110,67	119,0	28	38	75	—	15	45	2,10
48-8M-20	48	6F	GG	122,23	120,86	127,0	28	38	75	—	15	45	2,44
56-8M-20	56	6WF	GG	142,60	141,23	148,0	28	38	80	117	15	45	2,60
64-8M-20	64	6WF	GG	162,97	161,60	168,0	28	38	80	137	15	45	2,90
72-8M-20	72	6WF	GG	183,35	181,97	192,0	28	38	80	158	15	45	3,10
80-8M-20	80	6A	GG	203,72	202,35	—	28	38	90	180	15	50	3,80
90-8M-20	90	6A	GG	229,18	227,81	—	28	38	90	204	15	50	4,20
112-8M-20	112	6A	GG	285,21	283,83	—	28	38	90	260	18	50	5,20
144-8M-20	144	6A	GG	366,69	365,32	—	28	38	90	341	20	50	7,50
168-8M-20	168	6A	GG	427,81	426,44	—	28	38	100	402	20	55	10,00
192-8M-20	192	6A	GG	488,92	487,55	—	28	38	100	463	20	55	14,40

Type 8M – Teilung Pitch 8 mm für Riemenbreite for belt width 30 mm

22-8M-30	22	6F	St	56,02	54,65	60,0	38	48	43	—	12	30	0,69
24-8M-30	24	6F	St	61,12	59,75	66,0	38	48	45	—	12	30	0,84
26-8M-30	26	6F	St	66,21	64,84	71,0	38	48	50	—	12	35	1,00
28-8M-30	28	6F	St	71,30	70,08	75,0	38	48	50	—	15	35	1,12
30-8M-30	30	6F	St	76,39	75,13	83,0	38	48	55	—	15	35	1,32
32-8M-30	32	6F	St	81,49	80,16	87,0	38	48	60	—	15	40	1,50
34-8M-30	34	6F	St	86,58	85,22	91,0	38	48	70	—	15	45	1,80
36-8M-30	36	6F	St	91,67	90,30	98,5	38	48	70	—	15	45	1,99
38-8M-30	38	6F	St	96,77	95,39	103,0	38	48	75	—	15	45	2,27
40-8M-30	40	6F	GG	101,86	100,49	106,0	38	48	75	—	15	45	2,40
44-8M-30	44	6F	GG	112,05	110,67	119,0	38	48	75	—	15	45	2,80
48-8M-30	48	6F	GG	122,23	120,86	127,0	38	48	75	—	15	45	3,20
56-8M-30	56	6WF	GG	142,60	141,23	148,0	38	48	90	117	15	50	3,60
64-8M-30	64	6WF	GG	162,97	161,60	168,0	38	48	90	137	15	50	4,30
72-8M-30	72	6WF	GG	183,35	181,97	192,0	38	48	95	158	15	50	4,80
80-8M-30	80	6A	GG	203,72	202,35	—	38	48	100	180	15	55	5,10
90-8M-30	90	6A	GG	229,18	227,81	—	38	48	100	204	15	55	5,70
112-8M-30	112	6A	GG	285,21	283,83	—	38	48	100	260	18	55	6,80
144-8M-30	144	6A	GG	366,69	365,32	—	38	48	100	341	20	55	9,30
168-8M-30	168	6A	GG	427,81	426,44	—	38	48	100	402	20	55	11,40
192-8M-30	192	6A	GG	488,92	487,55	—	38	48	100	463	20	55	16,00

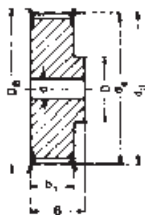

Ausf. Type 6F

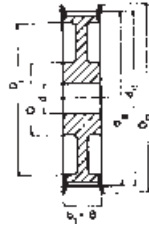

Ausf. Type 10WF



Ausf. Type 10A

Type 8M – Teilung Pitch 8 mm für Riemenbreite for belt width 50 mm

Bezeichnung Part no.	Anzahl der Zähne No. of teeth	Aus- führung Type	Material	d _d (mm)	d _a (mm)	D _B (mm)	b ₁ (mm)	B (mm)	D (mm)	D _i (mm)	Vor- bohrung Pilot bore d (mm)	Fertig- bohrung Finished bore d _{max} (mm)	Gewicht Weight (≈ kg)
22-8M-50	22	6F	St	56,02	54,65	60,0	60	70	43	—	12	30	1,00
24-8M-50	24	6F	St	61,12	59,75	66,0	60	70	45	—	12	30	1,20
26-8M-50	26	6F	St	66,21	64,84	71,0	60	70	50	—	12	35	1,50
28-8M-50	28	6F	St	71,30	70,08	75,0	60	70	50	—	15	35	1,67
30-8M-50	30	6F	St	76,39	75,13	83,0	60	70	55	—	15	35	1,97
32-8M-50	32	6F	St	81,49	80,16	87,0	60	70	60	—	15	40	2,27
34-8M-50	34	6F	St	86,58	85,22	91,0	60	70	70	—	15	45	2,69
36-8M-50	36	6F	St	91,67	90,30	98,5	60	70	70	—	15	45	2,97
38-8M-50	38	6F	St	96,77	95,39	103,0	60	70	75	—	15	45	3,23
40-8M-50	40	6F	GG	101,86	100,49	106,0	60	70	75	—	18	45	3,50
44-8M-50	44	6F	GG	112,05	110,67	119,0	60	70	75	—	18	45	3,90
48-8M-50	48	6F	GG	122,23	120,86	127,0	60	70	80	—	18	45	4,30
56-8M-50	56	10WF	GG	142,60	141,23	148,0	60	60	90	117	18	50	5,00
64-8M-50	64	10WF	GG	162,97	161,60	168,0	60	60	100	137	18	55	5,60
72-8M-50	72	10WF	GG	183,35	181,97	192,0	60	60	100	158	18	55	6,80
80-8M-50	80	10A	GG	203,72	202,35	—	60	60	110	180	18	60	6,90
90-8M-50	90	10A	GG	229,18	227,81	—	60	60	110	204	18	60	8,60
112-8M-50	112	10A	GG	285,21	283,83	—	60	60	110	260	18	60	9,60
144-8M-50	144	10A	GG	366,69	365,32	—	60	60	110	341	20	60	13,80
168-8M-50	168	10A	GG	427,81	426,44	—	60	60	120	402	20	65	16,00
192-8M-50	192	10A	GG	488,92	487,55	—	60	60	130	463	20	70	22,40

Type 8M – Teilung Pitch 8 mm für Riemenbreite for belt width 85 mm

22-8M-85	22	6F	St	56,02	54,65	60,0	95	105	43	—	12	30	1,55
24-8M-85	24	6F	St	61,12	59,75	66,0	95	105	45	—	12	30	1,90
26-8M-85	26	6F	St	66,21	64,84	71,0	95	105	50	—	12	35	2,25
28-8M-85	28	6F	St	71,30	70,08	75,0	95	105	50	—	15	35	2,55
30-8M-85	30	6F	St	76,39	75,13	83,0	95	105	55	—	15	35	3,00
32-8M-85	32	6F	St	81,49	80,16	87,0	95	105	60	—	15	40	3,57
34-8M-85	34	6F	St	86,58	85,22	91,0	95	105	70	—	15	45	4,00
36-8M-85	36	6F	St	91,67	90,30	98,5	95	105	70	—	15	45	4,50
38-8M-85	38	6F	St	96,77	95,39	103,0	95	105	75	—	15	45	4,90
40-8M-85	40	6F	GG	101,86	100,49	106,0	95	105	75	—	18	45	5,20
44-8M-85	44	6F	GG	112,05	110,67	119,0	95	105	75	—	18	45	6,60
48-8M-85	48	6F	GG	122,23	120,86	127,0	95	105	80	—	18	45	7,60
56-8M-85	56	6F	GG	142,60	141,23	148,0	95	105	80	—	20	50	9,80
64-8M-85	64	10WF	GG	162,97	161,60	168,0	95	95	100	137	20	55	10,40
72-8M-85	72	10WF	GG	183,35	181,97	192,0	95	95	110	158	20	60	11,40
80-8M-85	80	10A	GG	203,72	202,35	—	95	95	110	180	20	60	11,10
90-8M-85	90	10A	GG	229,18	227,81	—	95	95	110	204	20	60	13,20
112-8M-85	112	10A	GG	285,21	283,83	—	95	95	110	260	24	60	16,30
144-8M-85*	144	10A	GG	366,69	365,32	—	95	95	120	341	24	65	21,50
168-8M-85*	168	10A	GG	427,81	426,44	—	95	95	120	402	24	65	26,10
192-8M-85*	192	10A	GG	488,92	487,55	—	95	95	130	463	24	70	30,60

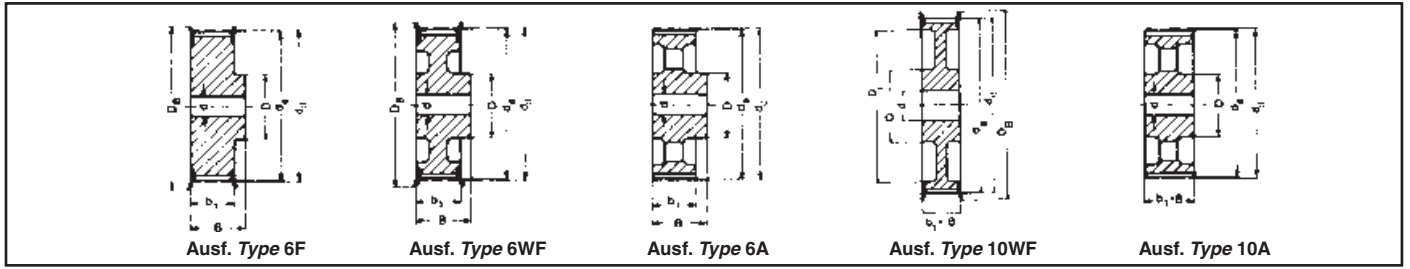

Type 14M – Teilung Pitch 14 mm für Riemenbreite for belt width 40 mm

Bezeichnung Part no.	Anzahl der Zähne No. of teeth	Aus- führung Type	Material	d _d (mm)	d _a (mm)	D _B (mm)	b ₁ (mm)	B (mm)	D (mm)	D _i (mm)	Vor- bohrung Pilot bore d (mm)	Fertig- bohrung Finished bore d _{max} (mm)	Gewicht Weight (≈ kg)
28-14M-40	28	6F	GG	124,78	122,12	127	54	69	100	—	24	60	4,73
29-14M-40	29	6F	GG	129,23	126,57	138	54	69	100	—	24	60	5,09
30-14M-40	30	6F	GG	133,69	130,99	138	54	69	100	—	24	60	5,45
32-14M-40	32	6F	GG	142,60	139,88	154	54	69	100	—	24	70	6,17
34-14M-40	34	6F	GG	151,52	148,79	160	54	69	100	—	24	70	6,88
36-14M-40	36	6F	GG	160,43	157,68	168	54	69	100	—	24	70	7,60
38-14M-40	38	6F	GG	169,34	166,60	183	54	69	120	—	24	70	8,28
40-14M-40	40	6F	GG	178,25	175,49	188	54	69	120	—	24	70	9,26
44-14M-40	44	6F	GG	196,08	193,28	211	54	69	120	—	24	70	10,32
48-14M-40	48	6WF	GG	213,90	211,11	226	54	69	135	172	24	70	11,50
56-14M-40	56	6WF	GG	249,55	246,76	256	54	69	135	207	28	70	13,05
64-14M-40	64	6WF	GG	285,21	282,41	296	54	69	135	242	28	70	14,40
72-14M-40	72	6A	GG	320,86	318,06	—	54	69	135	278	28	70	16,90
80-14M-40	80	6A	GG	356,51	353,71	—	54	69	135	314	28	70	18,50
90-14M-40	90	6A	GG	401,07	398,28	—	54	69	135	358	28	70	20,00
112-14M-40*	112	6A	GG	499,11	496,32	—	54	69	135	456	28	70	26,70
144-14M-40*	144	6A	GG	641,71	638,92	—	54	69	135	600	28	70	35,00
168-14M-40*	168	6A	GG	748,66	745,87	—	54	69	135	706	28	70	44,20
192-14M-40*	192	6A	GG	855,62	852,82	—	54	69	135	813	28	70	52,20
216-14M-40*	216	6A	GG	962,57	959,77	—	54	69	150	920	28	80	60,00

Type 14M – Teilung Pitch 14 mm für Riemenbreite for belt width 55 mm

28-14M-55	28	6F	GG	124,78	122,12	127	70	85	100	—	24	60	5,60
29-14M-55	29	6F	GG	129,23	126,57	138	70	85	100	—	24	60	6,10
30-14M-55	30	6F	GG	133,69	130,99	138	70	85	100	—	24	60	6,60
32-14M-55	32	6F	GG	142,60	139,88	154	70	85	100	—	24	70	7,60
34-14M-55	34	6F	GG	151,52	148,79	160	70	85	100	—	24	70	8,60
36-14M-55	36	6F	GG	160,43	157,68	168	70	85	100	—	24	70	9,60
38-14M-55	38	6F	GG	169,34	166,60	183	70	85	120	—	24	70	10,80
40-14M-55	40	6F	GG	178,25	175,49	188	70	85	120	—	24	70	11,20
44-14M-55	44	6F	GG	196,08	193,28	211	70	85	120	—	24	70	12,50
48-14M-55	48	10WF	GG	213,90	211,11	226	70	70	135	172	24	70	13,70
56-14M-55	56	10WF	GG	249,55	246,76	256	70	70	135	207	28	70	14,50
64-14M-55	64	10WF	GG	285,21	282,41	296	70	70	135	242	28	70	15,60
72-14M-55	72	10A	GG	320,86	318,06	—	70	70	135	278	28	70	18,50
80-14M-55	80	10A	GG	356,51	353,71	—	70	70	135	314	28	70	20,00
90-14M-55	90	10A	GG	401,07	398,28	—	70	70	135	358	28	70	22,60
112-14M-55*	112	10A	GG	499,11	496,32	—	70	70	135	456	28	70	29,50
144-14M-55*	144	10A	GG	641,71	638,92	—	70	70	135	600	28	70	39,00
168-14M-55*	168	10A	GG	748,66	745,87	—	70	70	135	706	28	70	48,50
192-14M-55*	192	10A	GG	855,62	852,82	—	70	70	135	813	28	70	57,80
216-14M-55*	216	10A	GG	962,57	959,77	—	70	70	150	920	28	80	67,00

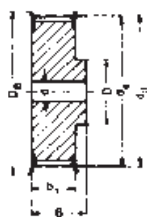

Ausf. Type 6F

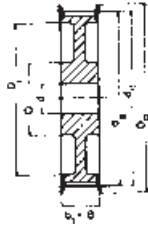

Ausf. Type 10WF



Ausf. Type 10A

Type 14M – Teilung Pitch 14 mm für Riemenbreite for belt width 85 mm

Bezeichnung Part no.	Anzahl der Zähne No. of teeth	Aus- führung Type	Material	d _d (mm)	d _a (mm)	D _B (mm)	b ₁ (mm)	B (mm)	D (mm)	D _i (mm)	Vor- bohrung Pilot bore d (mm)	Fertig- bohrung Finished bore d _{max} (mm)	Gewicht Weight (≈ kg)
28-14M-85	28	6F	GG	124,78	122,12	127	102	117	100	—	24	60	7,70
29-14M-85	29	6F	GG	129,23	126,57	138	102	117	100	—	24	60	8,40
30-14M-85	30	6F	GG	133,69	130,99	138	102	117	100	—	24	60	9,10
32-14M-85	32	6F	GG	142,60	139,88	154	102	117	100	—	24	60	10,50
34-14M-85	34	6F	GG	151,52	148,79	160	102	117	100	—	24	70	11,90
36-14M-85	36	6F	GG	160,43	157,68	168	102	117	100	—	32	70	13,20
38-14M-85	38	6F	GG	169,34	166,60	183	102	117	120	—	32	70	15,15
40-14M-85	40	6F	GG	178,25	175,49	188	102	117	135	—	32	70	17,10
44-14M-85	44	6F	GG	196,08	193,28	211	102	117	135	—	32	70	23,30
48-14M-85	48	6F	GG	213,90	211,11	226	102	117	150	—	32	80	25,00
56-14M-85	56	10WF	GG	249,55	246,76	256	102	102	150	207	32	80	25,00
64-14M-85	64	10WF	GG	285,21	282,41	296	102	102	150	242	32	80	28,20
72-14M-85	72	10A	GG	320,86	318,06	—	102	102	150	278	32	80	28,80
80-14M-85	80	10A	GG	356,51	353,71	—	102	102	150	314	32	80	30,10
90-14M-85	90	10A	GG	401,07	398,28	—	102	102	150	358	32	80	33,00
112-14M-85*	112	10A	GG	499,11	496,32	—	102	102	150	456	32	80	41,80
144-14M-85*	144	10A	GG	641,71	638,92	—	102	102	150	600	32	80	52,40
168-14M-85*	168	10A	GG	748,66	745,87	—	102	102	150	706	32	80	60,30
192-14M-85*	192	10A	GG	855,62	852,82	—	102	102	165	813	32	90	70,20
216-14M-85*	216	10A	GG	962,57	959,77	—	102	102	165	920	32	90	81,00

Type 14M – Teilung Pitch 14 mm für Riemenbreite for belt width 115 mm

28-14M-115	28	6F	GG	124,78	122,12	127	133	148	100	—	32	60	9,20
29-14M-115	29	6F	GG	129,23	126,57	138	133	148	100	—	32	60	10,20
30-14M-115	30	6F	GG	133,69	130,99	138	133	148	100	—	32	60	11,20
32-14M-115	32	6F	GG	142,60	139,88	154	133	148	100	—	32	60	13,20
34-14M-115	34	6F	GG	151,52	148,79	160	133	148	100	—	32	70	14,80
36-14M-115	36	6F	GG	160,43	157,68	168	133	148	120	—	32	70	16,60
38-14M-115	38	6F	GG	169,34	166,60	183	133	148	120	—	32	70	19,20
40-14M-115	40	6F	GG	178,25	175,49	188	133	148	135	—	32	70	22,10
44-14M-115	44	6F	GG	196,08	193,28	211	133	148	140	—	32	80	28,00
48-14M-115	48	6F	GG	213,90	211,11	226	133	148	150	—	32	80	35,00
56-14M-115	56	6F	GG	249,55	246,76	256	133	148	150	—	32	80	44,20
64-14M-115	64	10WF	GG	285,21	282,41	296	133	133	150	242	32	80	36,80
72-14M-115	72	10A	GG	320,86	318,06	—	133	133	150	278	32	80	36,10
80-14M-115	80	10A	GG	356,51	353,71	—	133	133	150	314	32	80	38,60
90-14M-115	90	10A	GG	401,07	398,28	—	133	133	150	358	32	80	41,00
112-14M-115*	112	10A	GG	499,11	496,32	—	133	133	150	456	32	80	54,40
144-14M-115*	144	10A	GG	641,71	638,92	—	133	133	165	600	32	90	67,80
168-14M-115*	168	10A	GG	748,66	745,87	—	133	133	165	706	32	90	75,80
192-14M-115*	192	10A	GG	855,62	852,82	—	133	133	165	813	32	90	88,30
216-14M-115*	216	10A	GG	962,57	959,77	—	133	133	165	920	32	90	98,00

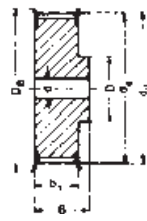

Ausf. Type 6F

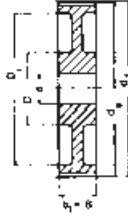

Ausf. Type 10W



Ausf. Type 10A

Type 14M – Teilung Pitch 14 mm für Riemenbreite for belt width 170 mm

Bezeichnung Part no.	Anzahl der Zähne No. of teeth	Aus- führung Type	Material	d _d (mm)	d _a (mm)	D _B (mm)	b ₁ (mm)	B (mm)	D (mm)	D _i (mm)	Vor- bohrung Pilot bore d (mm)	Fertig- bohrung Finished bore d _{max} (mm)	Gewicht Weight (≈ kg)
28-14M-170*	28	6F	GG	124,78	122,12	127	187	202	100	—	32	60	13,80
29-14M-170*	29	6F	GG	129,23	126,57	138	187	202	100	—	32	60	14,20
30-14M-170*	30	6F	GG	133,69	130,99	138	187	202	100	—	32	60	15,60
32-14M-170*	32	6F	GG	142,60	139,88	154	187	202	100	—	32	60	18,10
34-14M-170*	34	6F	GG	151,52	148,79	160	187	202	100	—	32	60	20,40
36-14M-170*	36	6F	GG	160,43	157,68	168	187	202	120	—	32	70	23,50
38-14M-170*	38	6F	GG	169,34	166,60	183	187	202	135	—	32	70	26,50
40-14M-170*	40	6F	GG	178,25	175,49	188	187	202	140	—	32	85	30,10
44-14M-170*	44	6F	GG	196,08	193,28	211	187	202	160	—	32	85	37,80
48-14M-170*	48	6F	GG	213,90	211,11	226	187	202	160	—	32	85	44,50
56-14M-170*	56	6F	GG	249,55	246,76	256	187	202	160	—	32	85	61,00
64-14M-170*	64	6F	GG	285,21	282,41	296	187	202	180	—	32	100	81,00
72-14M-170*	72	10W	GG	320,86	318,06	—	187	187	180	278	32	100	61,40
80-14M-170*	80	10W	GG	356,51	353,71	—	187	187	180	314	32	100	65,00
90-14M-170*	90	10A	GG	401,07	398,28	—	187	187	180	358	38	100	68,00
112-14M-170*	112	10A	GG	499,11	496,32	—	187	187	200	456	38	110	87,50
144-14M-170*	144	10A	GG	641,71	638,92	—	187	187	220	600	38	120	114,80
168-14M-170*	168	10A	GG	748,66	745,87	—	187	187	220	706	38	120	125,00
192-14M-170*	192	10A	GG	855,62	852,82	—	187	187	220	813	38	120	136,40
216-14M-170*	216	10A	GG	962,57	959,77	—	187	187	220	920	38	120	147,00

HTD®-Zahnscheiben Type 20M auf Anfrage
HTD® Pulleys type 20M on request

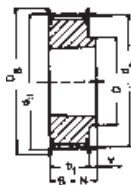

Ausf. Type 8F

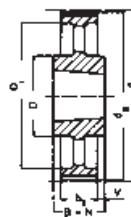

Ausf. Type 7a

Type 5M – Teilung Pitch 5 mm für Riemenbreite for belt width 15 mm

Bezeichnung Part no.	Anzahl der Zähne No. of teeth	Aus- führung Type	Material	d_d (mm)	d_a (mm)	D_B (mm)	b_1 (mm)	B (mm)	N (mm)	V (mm)	Z (mm)	D (mm)	D_1 (mm)	Taper- Buchse Taper bush	Gewicht ohne Buchse Weight without bush (= kg)
TB 34-5M-15	34	8F	St	54,11	52,97	57,0	20,5	22	22	1,5	—	43	—	1008	0,190
TB 36-5M-15	36	8F	St	57,30	56,16	60,0	20,5	22	22	1,5	—	44	—	1108	0,200
TB 38-5M-15	38	8F	St	69,48	59,34	66,0	20,5	22	22	1,5	—	48	—	1108	0,250
TB 40-5M-15	40	8F	St	63,66	62,52	71,0	20,5	22	22	1,5	—	52	—	1108	0,310
TB 44-5M-15	44	8F	St	70,03	68,89	75,0	20,5	22	22	1,5	—	54	—	1108	0,400
TB 48-5M-15	48	8F	St	76,39	75,25	83,0	20,5	25	25	4,5	—	64	—	1210	0,450
TB 56-5M-15	56	8F	GG	89,13	87,99	93,0	20,5	25	25	4,5	—	70	—	1210	0,670
TB 64-5M-15	64	8F	GG	101,86	100,72	106,0	20,5	25	25	4,5	—	78	—	1210	0,960
TB 72-5M-15	72	8F	GG	114,59	113,45	119,0	20,5	25	25	4,5	—	90	—	1610	1,190
TB 80-5M-15	80	8F	GG	127,32	126,18	135,0	20,5	25	25	4,5	—	92	—	1610	1,570
TB 90-5M-15	90	7A	GG	143,24	142,10	—	20,5	25	25	2,3	—	92	—	1610	1,147
TB 112-5M-15	112	7A	GG	178,25	177,11	—	20,5	25	25	2,3	—	92	—	1610	1,940
TB 136-5M-15	136	7A	GG	216,45	215,31	—	20,5	32	32	5,8	—	106	—	2012	3,060
TB 150-5M-15	150	7A	GG	238,73	237,59	—	20,5	32	32	5,8	—	106	—	2012	3,900

GG = Grauguss Cast iron
St = Stahl Steel

Fertigungstechnische Änderungen vorbehalten.
We reserve the right to make technical changes.
Bohrungsdurchmesser d_2 siehe Seite 89.
Bore diameters d_2 see page 89.

Taper-Buchse Taper bush	1008	1108	1210	1610	2012
Bohrung d_2 (mm) von ... bis ... Bore d_2 (mm) from ... to ...	10-25	10-28	11-32	14-42	14-50

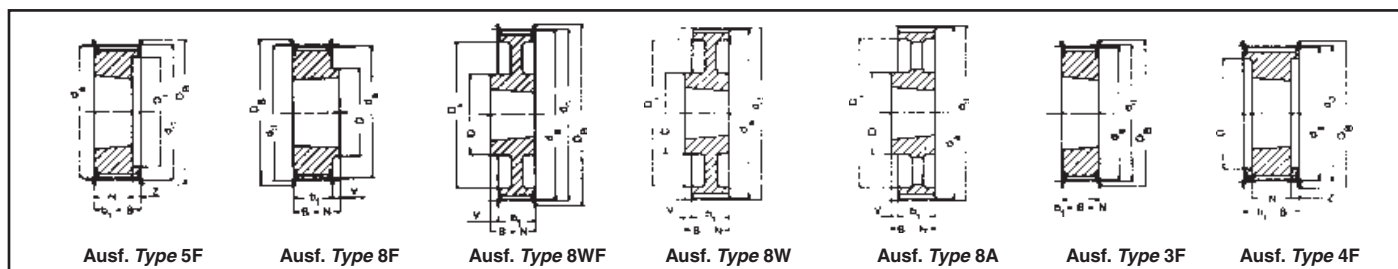

Type 8M – Teilung Pitch 8 mm für Riemenbreite for belt width 20 mm

Bezeichnung Part no.	Anzahl der Zähne No. of teeth	Aus- führung Type	Material	d _i (mm)	d _a (mm)	D _B (mm)	b ₁ (mm)	B (mm)	N (mm)	V (mm)	Z (mm)	D (mm)	D _i (mm)	Taper- Buchse Taper bush	Gewicht ohne Buchse Weight without bush (= kg)
TB 22-8M-20	22	5F	GG	56,02	54,65	60,0	28	28	22	—	6	—	41	1008	0,24
TB 24-8M-20	24	5F	GG	61,12	59,75	66,0	28	28	22	—	6	—	42	1108	0,30
TB 26-8M-20	26	5F	GG	66,21	64,84	71,0	28	28	22	—	6	—	46	1108	0,36
TB 28-8M-20	28	5F	GG	71,30	70,08	75,0	28	28	22	—	6	—	50	1108	0,44
TB 30-8M-20	30	5F	GG	76,39	75,13	83,0	28	28	22	—	6	—	58	1108	0,53
TB 32-8M-20	32	5F	GG	81,49	80,16	87,0	28	28	25	—	3	—	62	1610	0,42
TB 34-8M-20	34	5F	GG	86,58	85,22	91,0	28	28	25	—	3	—	65	1610	0,55
TB 36-8M-20	36	5F	GG	91,67	90,30	98,5	28	28	25	—	3	—	68	1610	0,68
TB 38-8M-20	38	5F	GG	96,77	95,39	103,0	28	28	25	—	3	—	72	1610	0,80
TB 40-8M-20	40	5F	GG	101,86	100,49	106,0	28	28	25	—	3	—	76	1610	1,00
TB 44-8M-20	44	8F	GG	112,05	110,67	119,0	28	32	32	4	—	93	—	2012	1,20
TB 48-8M-20	48	8F	GG	122,23	120,86	127,0	28	32	32	4	—	96	—	2012	1,60
TB 56-8M-20	56	8F	GG	142,60	141,23	148,0	28	32	32	4	—	110	—	2012	2,40
TB 64-8M-20	64	8WF	GG	162,97	161,60	168,0	28	32	32	4	—	110	137	2012	2,70
TB 72-8M-20	72	8WF	GG	183,35	181,97	192,0	28	32	32	4	—	110	158	2012	3,30
TB 80-8M-20	80	8W	GG	203,72	202,35	—	28	32	32	4	—	110	180	2012	3,50
TB 90-8M-20	90	8A	GG	229,18	227,81	—	28	32	32	4	—	110	204	2012	3,65

Type 8M – Teilung Pitch 8 mm für Riemenbreite for belt width 30 mm

TB 22-8M-30	22	5F	GG	56,02	54,65	60,0	38	38	22	—	16	—	41	1008	0,29
TB 24-8M-30	24	5F	GG	61,12	59,75	66,0	38	38	22	—	16	—	42	1108	0,38
TB 26-8M-30	26	5F	GG	66,21	64,84	71,0	38	38	22	—	16	—	46	1108	0,45
TB 28-8M-30	28	5F	GG	71,30	70,08	75,0	38	38	25	—	13	—	50	1210	0,50
TB 30-8M-30	30	3F	GG	76,39	75,13	83,0	38	38	38	—	—	—	—	1615	0,45
TB 32-8M-30	32	3F	GG	81,49	80,16	87,0	38	38	38	—	—	—	—	1615	0,59
TB 34-8M-30	34	3F	GG	86,58	85,22	91,0	38	38	38	—	—	—	—	1615	0,77
TB 36-8M-30	36	3F	GG	91,67	90,30	98,5	38	38	38	—	—	—	—	1615	0,96
TB 38-8M-30	38	3F	GG	96,77	95,39	103,0	38	38	38	—	—	—	—	1615	1,15
TB 40-8M-30	40	3F	GG	101,86	100,49	106,0	38	38	38	—	—	—	—	1615	1,34
TB 44-8M-30	44	4F	GG	112,05	110,67	119,0	38	38	32	—	3	—	91	2012	1,33
TB 48-8M-30	48	4F	GG	122,23	120,86	127,0	38	38	32	—	3	—	95	2012	1,78
TB 56-8M-30	56	4F	GG	142,60	141,23	148,0	38	38	32	—	3	—	117	2012	3,76
TB 64-8M-30	64	8F	GG	162,97	161,60	168,0	38	45	45	7	—	125	—	2517	4,20
TB 72-8M-30	72	8WF	GG	183,35	181,97	192,0	38	45	45	7	—	125	158	2517	4,30
TB 80-8M-30	80	8W	GG	203,72	202,35	—	38	45	45	7	—	125	180	2517	4,60
TB 90-8M-30	90	8A	GG	229,18	227,81	—	38	45	45	7	—	125	204	2517	5,00
TB 112-8M-30	112	8A	GG	285,21	283,83	—	38	45	45	7	—	125	260	2517	6,20
TB 144-8M-30	144	8A	GG	366,69	365,32	—	38	45	45	7	—	125	341	2517	9,00

GG = Grauguss Cast iron

Fertigungstechnische Änderungen vorbehalten.
We reserve the right to make technical changes.

Taper-Buchse Taper bush	1008	1108	1210	1610	1615	2012	2517
Bohrung d ₂ (mm) von ... bis ... Bore d ₂ (mm) from ... to ...	10-25	10-28	11-32	14-42	14-42	14-50	16-60

Bohrungsdurchmesser d₂ siehe Seite 89.
Bore diameters d₂ see page 89.

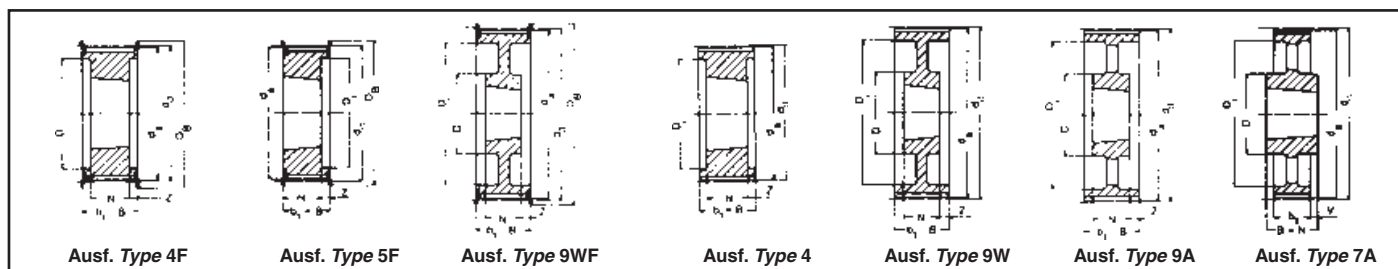

Type 8M – Teilung Pitch 8 mm für Riemenbreite for belt width 50 mm

Bezeichnung Part no.	Anzahl der Zähne No. of teeth	Aus- führung Type	Mate- rial	d _d (mm)	d _a (mm)	D _B (mm)	b ₁ (mm)	B (mm)	N (mm)	V (mm)	Z (mm)	D (mm)	D _i (mm)	Taper- Buchse Taper bush	Gewicht ohne Buchse Weight without bush (= kg)
TB 28-8M-50	28	5F	GG	71,30	70,08	75,0	60	60	25	—	35,0	—	50	1210	0,60
TB 30-8M-50	30	5F	GG	76,39	75,13	83,0	60	60	38	—	22,0	—	58	1615	0,65
TB 32-8M-50	32	5F	GG	81,49	80,16	87,0	60	60	38	—	22,0	—	62	1615	0,82
TB 34-8M-50	34	5F	GG	86,58	85,22	91,0	60	60	38	—	22,0	—	65	1615	1,06
TB 36-8M-50	36	5F	GG	91,67	90,30	98,5	60	60	38	—	22,0	—	68	1615	1,30
TB 38-8M-50	38	5F	GG	96,77	95,39	103,0	60	60	38	—	22,0	—	72	1615	1,60
TB 40-8M-50	40	4F	GG	101,86	100,49	106,0	60	60	32	—	14,0	—	82	2012	1,71
TB 44-8M-50	44	4F	GG	112,05	110,67	119,0	60	60	32	—	14,0	—	91	2012	1,78
TB 48-8M-50	48	4F	GG	122,23	120,86	127,0	60	60	32	—	14,0	—	95	2012	2,30
TB 56-8M-50	56	4F	GG	142,60	141,23	148,0	60	60	45	—	7,5	—	116	2517	3,40
TB 64-8M-50	64	4F	GG	162,97	161,60	168,0	60	60	45	—	7,5	—	137	2517	5,00
TB 72-8M-50	72	9WF	GG	183,35	181,97	192,0	60	60	45	—	7,5	125	158	2517	6,70
TB 80-8M-50	80	4	GG	203,72	202,35	—	60	60	51	—	4,5	—	180	3020	8,80
TB 90-8M-50	90	9W	GG	229,18	227,81	—	60	60	51	—	4,5	170	204	3020	10,00
TB 112-8M-50	112	9W	GG	285,21	283,83	—	60	60	51	—	4,5	170	260	3020	12,00
TB 144-8M-50	144	9A	GG	366,69	365,32	—	60	60	51	—	4,5	170	341	3020	15,20
TB 168-8M-50	168	7A	GG	427,81	426,44	—	60	65	65	—	2,5	170	402	3525	16,40
TB 192-8M-50	192	7A	GG	488,92	487,55	—	60	65	65	—	2,5	170	460	3525	21,80

Type 8M – Teilung Pitch 8 mm für Riemenbreite for belt width 85 mm

TB 34-8M-85	34	4F	GG	86,58	85,22	91,0	95	95	38	—	28,5	—	65	1615	1,43
TB 36-8M-85	36	4F	GG	91,67	90,30	98,5	95	95	38	—	28,5	—	68	1615	1,87
TB 38-8M-85	38	4F	GG	96,77	95,39	103,0	95	95	38	—	28,5	—	72	1615	2,20
TB 40-8M-85	40	4F	GG	101,86	100,49	106,0	95	95	32	—	31,5	—	82	2012	1,78
TB 44-8M-85	44	4F	GG	112,05	110,67	119,0	95	95	32	—	31,5	—	91	2012	2,30
TB 48-8M-85	48	4F	GG	122,23	120,86	127,0	95	95	45	—	25,0	—	100	2517	2,66
TB 56-8M-85	56	4F	GG	142,60	141,23	148,0	95	95	45	—	25,0	—	117	2517	4,45
TB 64-8M-85	64	4F	GG	162,97	161,60	168,0	95	95	45	—	25,0	—	137	2517	6,20
TB 72-8M-85	72	4F	GG	183,35	181,97	192,0	95	95	51	—	22,0	—	158	3020	8,00
TB 80-8M-85	80	4	GG	203,72	202,35	—	95	95	51	—	22,0	—	180	3020	10,00
TB 90-8M-85	90	9W	GG	229,18	227,81	—	95	95	51	—	22,0	170	204	3020	10,80
TB 112-8M-85	112	9W	GG	285,21	283,83	—	95	95	51	—	22,0	170	260	3020	15,00
TB 144-8M-85	144	9A	GG	366,69	365,32	—	95	95	76	—	15,0	170	341	3525	20,00
TB 168-8M-85	168	9A	GG	427,81	426,44	—	95	95	76	—	15,0	170	402	3525	23,00
TB 192-8M-85	192	9A	GG	488,92	487,55	—	95	95	76	—	15,0	170	460	3525	28,50

GG = Grauguss Cast iron

Fertigungstechnische Änderungen vorbehalten.
We reserve the right to make technical changes.

Taper-Buchse Taper bush	1210	1615	2012	2517	3020	3525
Bohrung d ₂ (mm) von ... bis ... Bore d ₂ (mm) from ... to ...	11-32	14-42	14-50	16-60	25-75	35-90

Bohrungsdurchmesser d₂ siehe Seite 89.
Bore diameters d₂ see page 89.

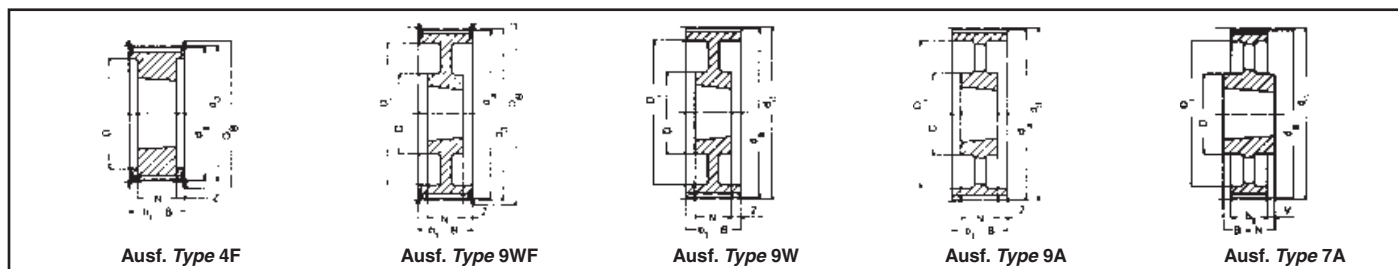

Type 14M – Teilung Pitch 14 mm für Riemenbreite for belt width 40 mm

Bezeichnung Part no.	Anzahl der Zähne No. of teeth	Aus- führung Type	Mate- rial	d _d (mm)	d _a (mm)	D _B (mm)	b ₁ (mm)	B (mm)	N (mm)	V (mm)	Z (mm)	D (mm)	D _i (mm)	Taper- Buchse Taper bush	Gewicht ohne Buchse Weight without bush (= kg)
TB 28-14M-40	28	4F	GG	124,78	122,12	127	54	54	32	—	11,0	—	98	2012	2,00
TB 29-14M-40	29	4F	GG	129,23	126,57	138	54	54	32	—	11,0	—	100	2012	2,38
TB 30-14M-40	30	4F	GG	133,69	130,99	138	54	54	32	—	11,0	—	100	2012	2,65
TB 32-14M-40	32	4F	GG	142,60	139,88	154	54	54	32	—	11,0	—	104	2012	3,40
TB 34-14M-40	34	4F	GG	151,52	148,79	160	54	54	45	—	4,5	—	110	2517	3,87
TB 36-14M-40	36	4F	GG	160,43	157,68	168	54	54	45	—	4,5	—	120	2517	4,80
TB 38-14M-40	38	4F	GG	169,34	166,60	183	54	54	45	—	4,5	—	130	2517	5,40
TB 40-14M-40	40	4F	GG	178,25	175,49	188	54	54	45	—	4,5	—	138	2517	6,00
TB 44-14M-40	44	4F	GG	196,08	193,28	211	54	54	51	—	1,5	—	155	3020	7,80
TB 48-14M-40	48	4F	GG	213,90	211,11	226	54	54	51	—	1,5	—	170	3020	9,40
TB 56-14M-40	56	9WF	GG	249,55	246,76	256	54	54	51	—	1,5	170	208	3020	10,80
TB 64-14M-40	64	9WF	GG	285,21	282,41	296	54	54	51	—	1,5	170	242	3020	13,40
TB 72-14M-40	72	9W	GG	320,86	318,06	—	54	54	51	—	1,5	170	280	3020	15,20
TB 80-14M-40	80	9A	GG	356,51	353,71	—	54	54	51	—	1,5	170	315	3020	16,00
TB 90-14M-40	90	9A	GG	401,07	398,28	—	54	54	51	—	1,5	170	360	3020	17,80
TB 112-14M-40	112	9A	GG	499,11	496,32	—	54	54	51	—	1,5	170	457	3020	25,60
TB 144-14M-40	144	9A	GG	641,71	638,92	—	54	54	51	—	1,5	170	600	3020	32,00
TB 168-14M-40	168	9A	GG	748,66	745,87	—	54	54	51	—	1,5	170	706	3020	44,00
TB 192-14M-40	192	9A	GG	855,62	852,82	—	54	54	51	—	1,5	170	813	3020	49,00
TB 216-14M-40	216	9A	GG	962,57	959,77	—	54	54	51	—	1,5	170	920	3020	55,00

Type 14M – Teilung Pitch 14 mm für Riemenbreite for belt width 55 mm

TB 28-14M-55	28	4F	GG	124,78	122,12	127	70	70	32	—	19,0	—	98	2012	2,20
TB 29-14M-55	29	4F	GG	129,23	126,57	138	70	70	32	—	19,0	—	100	2012	2,74
TB 30-14M-55	30	4F	GG	133,69	130,99	138	70	70	45	—	12,5	—	100	2517	2,70
TB 32-14M-55	32	4F	GG	142,60	139,88	154	70	70	45	—	12,5	—	108	2517	3,66
TB 34-14M-55	34	4F	GG	151,52	148,79	160	70	70	45	—	12,5	—	110	2517	4,55
TB 36-14M-55	36	4F	GG	160,43	157,68	168	70	70	45	—	12,5	—	120	2517	5,20
TB 38-14M-55	38	4F	GG	169,34	166,60	183	70	70	45	—	12,5	—	130	2517	6,20
TB 40-14M-55	40	4F	GG	178,25	175,49	188	70	70	45	—	12,5	—	138	2517	7,00
TB 44-14M-55	44	4F	GG	196,08	193,28	211	70	70	51	—	9,5	—	155	3020	8,60
TB 48-14M-55	48	4F	GG	213,90	211,11	226	70	70	51	—	9,5	—	170	3020	10,40
TB 56-14M-55	56	9WF	GG	249,55	246,76	256	70	70	51	—	9,5	170	208	3020	12,00
TB 64-14M-55	64	9WF	GG	285,21	282,41	296	70	70	51	—	9,5	170	242	3020	14,50
TB 72-14M-55	72	9W	GG	320,86	318,06	—	70	70	51	—	9,5	170	280	3020	16,20
TB 80-14M-55	80	9A	GG	356,51	353,71	—	70	70	51	—	9,5	170	315	3020	17,50
TB 90-14M-55	90	9A	GG	401,07	398,28	—	70	70	51	—	9,5	170	360	3020	20,10
TB 112-14M-55	112	9A	GG	499,11	496,32	—	70	70	51	—	9,5	170	457	3020	28,40
TB 144-14M-55	144	9A	GG	641,71	638,92	—	70	70	51	—	9,5	170	600	3020	36,20
TB 168-14M-55	168	9A	GG	748,66	745,87	—	70	70	51	—	9,5	170	706	3020	49,00
TB 192-14M-55	192	9A	GG	855,62	852,82	—	70	70	51	—	9,5	170	813	3020	53,00
TB 216-14M-55	216	7A	GG	962,57	959,77	—	70	89	89	9,5	—	190	920	3535	65,80

GG = Grauguss Cast iron

Fertigungstechnische Änderungen vorbehalten.
We reserve the right to make technical changes.

Taper-Buchse Taper bush	2012	2517	3020	3535
Bohrung d ₂ (mm) von ... bis ... Bore d ₂ (mm) from ... to ...	14-50	16-60	25-75	35-90

Bohrungsdurchmesser d₂ siehe Seite 89.
Bore diameters d₂ see page 89.

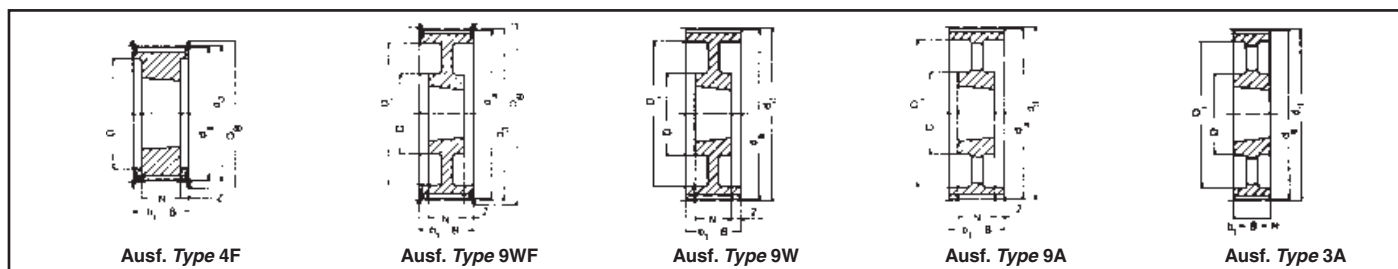

Type 14M – Teilung Pitch 14 mm für Riemenbreite for belt width 85 mm

Bezeichnung Part no.	Anzahl der Zähne No. of teeth	Ausführung Type	Material	d_d (mm)	d_a (mm)	D_B (mm)	b_1 (mm)	B (mm)	N (mm)	V (mm)	Z (mm)	D (mm)	D_i (mm)	Taper-Buchse Taper bush	Gewicht ohne Buchse Weight without bush (= kg)
TB 28-14M-85	28	4F	GG	124,78	122,12	127	102	102	45	—	28,5	—	98	2517	2,70
TB 29-14M-85	29	4F	GG	129,23	126,57	138	102	102	45	—	28,5	—	100	2517	3,40
TB 30-14M-85	30	4F	GG	133,69	130,99	138	102	102	45	—	28,5	—	100	2517	3,75
TB 32-14M-85	32	4F	GG	142,60	139,88	154	102	102	45	—	28,5	—	108	2517	4,80
TB 34-14M-85	34	4F	GG	151,52	148,79	160	102	102	45	—	28,5	—	110	2517	6,00
TB 36-14M-85	36	4F	GG	160,43	157,68	168	102	102	51	—	25,5	—	120	3020	5,80
TB 38-14M-85	38	4F	GG	169,34	166,60	183	102	102	51	—	25,5	—	130	3020	6,80
TB 40-14M-85	40	4F	GG	178,25	175,49	188	102	102	51	—	25,5	—	138	3020	8,00
TB 44-14M-85	44	4F	GG	196,08	193,28	211	102	102	76	—	13,0	—	155	3030	11,80
TB 48-14M-85	48	4F	GG	213,90	211,11	226	102	102	76	—	13,0	—	170	3030	15,10
TB 56-14M-85	56	4F	GG	249,55	246,76	256	102	102	65	—	18,5	190	210	3525	19,00
TB 64-14M-85	64	9WF	GG	285,21	282,41	296	102	102	65	—	18,5	190	242	3525	23,00
TB 72-14M-85	72	9W	GG	320,86	318,06	—	102	102	65	—	18,5	190	280	3525	25,00
TB 80-14M-85	80	9A	GG	356,51	353,71	—	102	102	65	—	18,5	190	315	3525	26,00
TB 90-14M-85	90	9A	GG	401,07	398,28	—	102	102	65	—	18,5	190	360	3525	27,80
TB 112-14M-85	112	9A	GG	499,11	496,32	—	102	102	65	—	18,5	190	457	3525	36,50
TB 144-14M-85	144	9A	GG	641,71	638,92	—	102	102	65	—	18,5	190	600	3525	48,00
TB 168-14M-85	168	9A	GG	748,66	745,87	—	102	102	65	—	18,5	190	706	3525	60,00
TB 192-14M-85	192	3A	GG	855,62	852,82	—	102	102	102	—	—	230	813	4040	86,00
TB 216-14M-85	216	3A	GG	962,57	959,77	—	102	102	102	—	—	230	920	4040	91,50

Type 14M – Teilung Pitch 14 mm für Riemenbreite for belt width 115 mm

TB 28-14M-115	28	4F	GG	124,78	122,12	127	133	133	45	—	44,0	—	98	2517	3,77
TB 29-14M-115	29	4F	GG	129,23	126,57	138	133	133	45	—	44,0	—	100	2517	4,00
TB 30-14M-115	30	4F	GG	133,69	130,99	138	133	133	45	—	44,0	—	100	2517	5,00
TB 32-14M-115	32	4F	GG	142,60	139,88	154	133	133	45	—	44,0	—	108	2517	6,80
TB 34-14M-115	34	4F	GG	151,52	148,79	160	133	133	45	—	44,0	—	110	2517	6,80
TB 36-14M-115	36	4F	GG	160,43	157,68	168	133	133	51	—	41,0	—	120	3020	7,00
TB 38-14M-115	38	4F	GG	169,34	166,60	183	133	133	51	—	41,0	—	130	3020	8,40
TB 40-14M-115	40	4F	GG	178,25	175,49	188	133	133	51	—	41,0	—	140	3020	9,20
TB 44-14M-115	44	4F	GG	196,08	193,28	211	133	133	76	—	28,5	—	155	3030	14,00
TB 48-14M-115	48	4F	GG	213,90	211,11	226	133	133	76	—	28,5	—	170	3030	17,10
TB 56-14M-115	56	4F	GG	249,55	246,76	256	133	133	89	—	22,0	—	210	3535	24,80
TB 64-14M-115	64	9WF	GG	285,21	282,41	296	133	133	89	—	22,0	190	242	3535	27,00
TB 72-14M-115	72	9W	GG	320,86	318,06	—	133	133	89	—	22,0	190	280	3535	29,00
TB 80-14M-115	80	9A	GG	356,51	353,71	—	133	133	89	—	22,0	190	315	3535	32,00
TB 90-14M-115	90	9A	GG	401,07	398,28	—	133	133	89	—	22,0	190	360	3535	36,50
TB 112-14M-115	112	9A	GG	499,11	496,32	—	133	133	89	—	22,0	190	457	3535	46,00
TB 144-14M-115	144	9A	GG	641,71	638,92	—	133	133	102	—	15,5	230	600	4040	68,00
TB 168-14M-115	168	9A	GG	748,66	745,87	—	133	133	102	—	15,5	230	706	4040	82,60
TB 192-14M-115	192	9A	GG	855,62	852,82	—	133	133	102	—	15,5	230	813	4040	96,00
TB 216-14M-115	216	9A	GG	962,57	959,77	—	133	133	102	—	15,5	230	920	4040	107,00

GG = Grauguss Cast iron

Fertigungstechnische Änderungen vorbehalten.
We reserve the right to make technical changes.

Taper-Buchse Taper bush	2517	3020	3030	3525	3535	4040
Bohrung d_2 (mm) von ... bis ... Bore d_2 (mm) from ... to ...	16-60	25-75	35-75	35-90	35-90	40-100

Bohrungsdurchmesser d_2 siehe Seite 89.
Bore diameters d_2 see page 89.

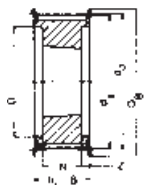

Ausf. Type 4F

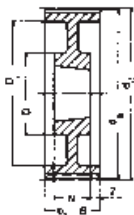

Ausf. Type 9W

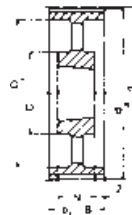

Ausf. Type 9A

Type 14M – Teilung Pitch 14 mm für Riemenbreite for belt width 170 mm

Bezeichnung Part no.	Anzahl der Zähne No. of teeth	Ausführung Type	Material	d_d (mm)	d_a (mm)	D_B (mm)	b_1 (mm)	B (mm)	N (mm)	V (mm)	Z (mm)	D (mm)	D_i (mm)	Taper-Buchse Taper bush	Gewicht ohne Buchse Weight without bush (= kg)
TB 38-14M-170*	38	4F	GG	169,34	166,60	183	187	187	76	—	55,5	—	130	3030	11,70
TB 40-14M-170*	40	4F	GG	178,25	175,49	188	187	187	76	—	55,5	—	140	3030	13,00
TB 44-14M-170*	44	4F	GG	196,08	193,28	211	187	187	89	—	49,0	—	155	3535	15,00
TB 48-14M-170*	48	4F	GG	213,90	211,11	226	187	187	89	—	49,0	—	175	3535	19,00
TB 56-14M-170*	56	4F	GG	249,55	246,76	256	187	187	89	—	49,0	—	210	3535	28,50
TB 64-14M-170*	64	4F	GG	285,21	282,41	296	187	187	102	—	42,5	—	240	4040	41,00
TB 72-14M-170*	72	9W	GG	320,86	318,06	—	187	187	102	—	42,5	230	280	4040	46,90
TB 80-14M-170*	80	9W	GG	356,51	353,71	—	187	187	102	—	42,5	230	315	4040	48,00
TB 90-14M-170*	90	9A	GG	401,07	398,28	—	187	187	102	—	42,5	230	360	4040	52,50
TB 112-14M-170*	112	9A	GG	499,11	496,32	—	187	187	127	—	30,0	265	457	5050	74,50
TB 144-14M-170*	144	9A	GG	641,71	638,92	—	187	187	127	—	30,0	265	600	5050	91,00
TB 168-14M-170*	168	9A	GG	748,66	745,87	—	187	187	127	—	30,0	265	706	5050	116,00
TB 192-14M-170*	192	9A	GG	855,62	852,82	—	187	187	127	—	30,0	265	813	5050	134,00
TB 216-14M-170*	216	9A	GG	962,57	959,77	—	187	187	127	—	30,0	265	920	5050	146,50

**HTD®-Zahnscheiben Type 20M auf Anfrage
 HTD® Pulleys type 20M on request**

GG = Grauguss Cast iron

Fertigungstechnische Änderungen vorbehalten.
 We reserve the right to make technical changes.

* **Keine Lagerware Non stock items**

Bohrungsdurchmesser d_2 siehe Seite 89.
 Bore diameters d_2 see page 89.

Taper-Buchse Taper bush	3030	3535	4040	5050
Bohrung d_2 (mm) von ... bis ... Bore d_2 (mm) from ... to ...	35-75	35-90	40-100	70-125

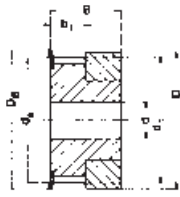

Ausf. Type 1F

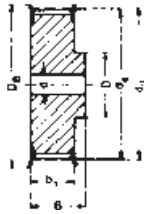

Ausf. Type 6F



Ausf. Type 6

Type T 2,5 – Teilung Pitch 2,5 mm für Riemenbreite for belt width 4 und and 6 mm

Bezeichnung Part no.	Anzahl der Zähne No. of teeth	Aus- führung Type	Material	d_g (mm)	d_a (mm)	D_B (mm)	b_1 (mm)	B (mm)	D (mm)	D_i (mm)	Vor- bohrung Pilot bore d (mm)	Fertig- bohrung Finished bore d_{max} (mm)	Gewicht Weight (≈ kg)
16 T2,5/12-2	12	1F	Al	9,55	9,00	13,0	9	16	12	—	—	3	0,003
16 T2,5/14-2	14	1F	Al	11,14	10,60	15,0	9	16	14	—	—	4	0,004
16 T2,5/15-2	15	1F	Al	11,94	11,40	15,0	9	16	15	—	—	4	0,005
16 T2,5/16-2	16	1F	Al	12,73	12,20	16,0	9	16	16	—	—	5	0,005
16 T2,5/18-2	18	6F	Al	14,32	13,80	17,5	10	16	9,5	—	4	6	0,006
16 T2,5/19-2	19	6F	Al	15,12	14,60	18,0	10	16	9,5	—	4	6	0,007
16 T2,5/20-2	20	6F	Al	15,92	15,40	19,5	10	16	10	—	4	6	0,008
16 T2,5/22-2	22	6F	Al	17,51	17,00	23,0	10	16	10	—	4	6	0,009
16 T2,5/24-2	24	6F	Al	19,10	18,55	23,0	10	16	12	—	4	6	0,012
16 T2,5/25-2	25	6F	Al	19,90	19,35	23,0	10	16	12	—	4	8	0,013
16 T2,5/26-2	26	6F	Al	20,70	20,15	25,0	10	16	13	—	4	8	0,014
16 T2,5/28-2	28	6F	Al	22,28	21,75	25,0	10	16	13	—	4	8	0,016
16 T2,5/30-2	30	6F	Al	23,87	23,35	28,0	10	16	16	—	6	10	0,018
16 T2,5/32-2	32	6F	Al	25,47	24,95	32,0	10	16	16	—	6	10	0,020
16 T2,5/36-2	36	6F	Al	28,65	28,10	36,0	10	16	20	—	6	12	0,026
16 T2,5/40-2	40	6F	Al	31,83	31,30	38,0	10	16	20	—	6	12	0,032
16 T2,5/44-2	44	6F	Al	35,02	34,50	42,0	10	16	24	—	6	14	0,040
16 T2,5/48-0	48	6	Al	38,20	37,70	—	10	16	26	—	6	15	0,048
16 T2,5/60-0	60	6	Al	47,75	47,25	—	10	16	34	—	8	18	0,073

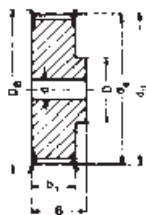

Ausf. Type 6F



Ausf. Type 6

Type T 5 – Teilung Pitch 5 mm für Riemenbreite for belt width 10 mm

Bezeichnung Part no.	Anzahl der Zähne No. of teeth	Aus- führung Type	Material	d _g (mm)	d _a (mm)	D _B (mm)	b ₁ (mm)	B (mm)	D (mm)	D _i (mm)	Vor- bohrung Pilot bore d (mm)	Fertig- bohrung Finished bore d _{max} (mm)	Gewicht Weight (≈ kg)
21 T5/10-2	10	6F	Al	15,92	15,05	19,5	15	21	8	—	—	5	0,012
21 T5/12-2	12	6F	Al	19,01	18,25	23,0	15	21	10	—	—	6	0,016
21 T5/14-2	14	6F	Al	22,29	21,45	25,0	15	21	13	—	—	8	0,019
21 T5/15-2	15	6F	Al	23,88	23,05	28,0	15	21	16	—	6	10	0,021
21 T5/16-2	16	6F	Al	25,47	24,60	32,0	15	21	18	—	6	11	0,025
21 T5/18-2	18	6F	Al	28,65	27,80	32,0	15	21	19	—	6	12	0,031
21 T5/19-2	19	6F	Al	30,25	29,40	36,0	15	21	22	—	6	12	0,036
21 T5/20-2	20	6F	Al	31,83	31,00	36,0	15	21	23	—	6	14	0,038
21 T5/22-2	22	6F	Al	35,12	34,25	38,0	15	21	24	—	6	15	0,046
21 T5/24-2	24	6F	Al	38,21	37,40	42,0	15	21	26	—	6	15	0,054
21 T5/25-2	25	6F	Al	39,80	39,00	44,0	15	21	26	—	6	15	0,058
21 T5/26-2	26	6F	Al	41,47	40,60	44,0	15	21	26	—	6	16	0,062
21 T5/27-2	27	6F	Al	42,98	42,20	48,0	15	21	30	—	8	18	0,064
21 T5/28-2	28	6F	Al	44,62	43,75	48,0	15	21	32	—	8	18	0,071
21 T5/30-2	30	6F	Al	47,76	46,95	51,0	15	21	34	—	8	18	0,075
21 T5/32-2	32	6F	Al	50,94	50,10	54,0	15	21	38	—	8	22	0,088
21 T5/36-2	36	6F	Al	57,31	56,45	63,0	15	21	38	—	8	22	0,114
21 T5/40-2	40	6F	Al	63,66	62,85	66,0	15	21	40	—	8	23	0,138
21 T5/42-2	42	6F	Al	66,87	66,00	71,0	15	21	40	—	8	24	0,180
21 T5/44-0	44	6	Al	70,07	69,20	—	15	21	45	—	8	26	0,185
21 T5/48-0	48	6	Al	76,42	75,55	—	15	21	50	—	8	28	0,200
21 T5/60-0	60	6	Al	95,52	94,65	—	15	21	65	—	8	35	0,307

Type T 5 – Teilung Pitch 5 mm für Riemenbreite for belt width 16 mm

27 T5/10-2	10	6F	Al	15,92	15,05	19,5	21	27	8	—	—	5	0,016
27 T5/12-2	12	6F	Al	19,01	18,25	23,0	21	27	10	—	—	6	0,022
27 T5/14-2	14	6F	Al	22,29	21,45	25,0	21	27	13	—	—	8	0,026
27 T5/15-2	15	6F	Al	23,88	23,05	28,0	21	27	16	—	6	10	0,029
27 T5/16-2	16	6F	Al	25,47	24,60	32,0	21	27	18	—	6	11	0,035
27 T5/18-2	18	6F	Al	28,65	27,80	32,0	21	27	19	—	6	12	0,043
27 T5/19-2	19	6F	Al	30,25	29,40	36,0	21	27	22	—	6	12	0,049
27 T5/20-2	20	6F	Al	31,83	31,00	36,0	21	27	23	—	6	14	0,053
27 T5/22-2	22	6F	Al	35,12	34,25	38,0	21	27	24	—	6	15	0,054
27 T5/24-2	24	6F	Al	38,21	37,40	42,0	21	27	26	—	6	15	0,076
27 T5/25-2	25	6F	Al	39,80	39,00	44,0	21	27	26	—	6	15	0,081
27 T5/26-2	26	6F	Al	41,47	40,60	44,0	21	27	26	—	6	16	0,085
27 T5/27-2	27	6F	Al	42,98	42,20	48,0	21	27	30	—	8	18	0,090
27 T5/28-2	28	6F	Al	44,62	43,75	48,0	21	27	32	—	8	18	0,092
27 T5/30-2	30	6F	Al	47,76	46,95	51,0	21	27	34	—	8	18	0,105
27 T5/32-2	32	6F	Al	50,94	50,10	54,0	21	27	38	—	8	22	0,123
27 T5/36-2	36	6F	Al	57,31	56,45	63,0	21	27	38	—	8	22	0,160
27 T5/40-2	40	6F	Al	63,66	62,85	66,0	21	27	40	—	8	23	0,193
27 T5/42-2	42	6F	Al	66,87	66,00	71,0	21	27	40	—	8	24	0,205
27 T5/44-0	44	6	Al	70,07	69,20	—	21	27	45	—	8	26	0,228
27 T5/48-0	48	6	Al	76,42	75,55	—	21	27	50	—	8	28	0,280
27 T5/60-0	60	6	Al	95,52	94,65	—	21	27	65	—	8	35	0,430

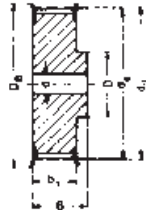

Ausf. Type 6F



Ausf. Type 6

Type T 5 – Teilung Pitch 5 mm für Riemenbreite for belt width 25 mm

Bezeichnung Part no.	Anzahl der Zähne No. of teeth	Aus- führung Type	Material	d _g (mm)	d _a (mm)	D _B (mm)	b ₁ (mm)	B (mm)	D (mm)	D _i (mm)	Vor- bohrung Pilot bore d (mm)	Fertig- bohrung Finished bore d _{max} (mm)	Gewicht Weight (≈ kg)
36 T5/10-2	10	6F	Al	15,92	15,05	19,5	30	36	8	—	—	5	0,023
36 T5/12-2	12	6F	Al	19,01	18,25	23,0	30	36	10	—	—	6	0,031
36 T5/14-2	14	6F	Al	22,29	21,45	25,0	30	36	13	—	—	8	0,037
36 T5/15-2	15	6F	Al	23,88	23,05	28,0	30	36	16	—	6	10	0,041
36 T5/16-2	16	6F	Al	25,47	24,60	32,0	30	36	18	—	6	11	0,050
36 T5/18-2	18	6F	Al	28,65	27,80	32,0	30	36	19	—	6	12	0,061
36 T5/19-2	19	6F	Al	30,25	29,40	36,0	30	36	22	—	6	12	0,070
36 T5/20-2	20	6F	Al	31,83	31,00	36,0	30	36	23	—	6	14	0,076
36 T5/22-2	22	6F	Al	35,12	34,25	38,0	30	36	24	—	6	15	0,080
36 T5/24-2	24	6F	Al	38,21	37,40	42,0	30	36	26	—	8	15	0,109
36 T5/25-2	25	6F	Al	39,80	39,00	44,0	30	36	26	—	8	15	0,116
36 T5/26-2	26	6F	Al	41,47	40,60	44,0	30	36	26	—	8	16	0,120
36 T5/27-2	27	6F	Al	42,98	42,20	48,0	30	36	30	—	8	18	0,128
36 T5/28-2	28	6F	Al	44,62	43,75	48,0	30	36	32	—	8	18	0,135
36 T5/30-2	30	6F	Al	47,76	46,95	51,0	30	36	34	—	8	18	0,150
36 T5/32-2	32	6F	Al	50,94	50,10	54,0	30	36	38	—	8	22	0,176
36 T5/36-2	36	6F	Al	57,31	56,45	63,0	30	36	38	—	8	22	0,230
36 T5/40-2	40	6F	Al	63,66	62,85	66,0	30	36	40	—	8	23	0,276
36 T5/42-2	42	6F	Al	66,87	66,00	71,0	30	36	40	—	8	24	0,284
36 T5/44-0	44	6	Al	70,07	69,20	—	30	36	45	—	8	26	0,315
36 T5/48-0	48	6	Al	76,42	75,55	—	30	36	50	—	8	28	0,400
36 T5/60-0	60	6	Al	95,52	94,65	—	30	36	65	—	8	35	0,614

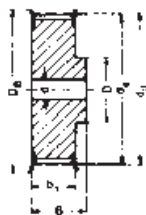

Ausf. Type 6F



Ausf. Type 6

Type T 10 – Teilung Pitch 10 mm für Riemenbreite for belt width 16 mm

Bezeichnung Part no.	Anzahl der Zähne No. of teeth	Aus- führung Type	Material	d _g (mm)	d _a (mm)	D _B (mm)	b ₁ (mm)	B (mm)	D (mm)	D _i (mm)	Vor- bohrung Pilot bore d (mm)	Fertig- bohrung Finished bore d _{max} (mm)	Gewicht Weight (≈ kg)
31 T10/12-2	12	6F	Al	38,20	36,35	42	21	31	28	—	6	16	0,076
31 T10/14-2	14	6F	Al	44,56	42,70	48	21	31	32	—	8	18	0,104
31 T10/15-2	15	6F	Al	47,75	45,90	51	21	31	32	—	8	18	0,116
31 T10/16-2	16	6F	Al	50,93	49,05	54	21	31	35	—	8	20	0,134
31 T10/18-2	18	6F	Al	57,29	55,45	60	21	31	40	—	8	22	0,167
31 T10/19-2	19	6F	Al	60,48	58,60	66	21	31	44	—	8	22	0,184
31 T10/20-2	20	6F	Al	63,66	61,80	66	21	31	46	—	8	24	0,208
31 T10/22-2	22	6F	Al	70,03	68,15	75	21	31	52	—	8	28	0,253
31 T10/24-2	24	6F	Al	76,39	74,55	83	21	31	58	—	8	30	0,288
31 T10/25-2	25	6F	Al	79,58	77,70	83	21	31	60	—	8	30	0,310
31 T10/26-2	26	6F	Al	82,76	80,90	87	21	31	60	—	8	30	0,357
31 T10/27-2	27	6F	Al	85,95	84,10	91	21	31	60	—	8	30	0,364
31 T10/28-2	28	6F	Al	89,13	87,25	93	21	31	60	—	8	30	0,401
31 T10/30-2	30	6F	Al	95,49	93,65	97	21	31	60	—	8	30	0,441
31 T10/32-2	32	6F	Al	101,86	100,00	106	21	31	65	—	10	32	0,493
31 T10/36-2	36	6F	Al	114,59	112,75	119	21	31	70	—	10	35	0,623
31 T10/40-2	40	6F	Al	127,32	125,45	131	21	31	80	—	10	40	0,767
31 T10/44-0	44	6	Al	140,06	138,20	—	21	31	88	—	10	46	0,993
31 T10/48-0	48	6	Al	152,78	150,95	—	21	31	95	—	16	48	1,090
31 T10/60-0	60	6	Al	190,98	189,10	—	21	31	110	—	16	60	1,710

Type T 10 – Teilung Pitch 10 mm für Riemenbreite for belt width 25 mm

40 T10/12-2	12	6F	Al	38,20	36,35	42	30	40	28	—	6	16	0,099
40 T10/14-2	14	6F	Al	44,56	42,70	48	30	40	32	—	8	18	0,134
40 T10/15-2	15	6F	Al	47,75	45,90	51	30	40	32	—	8	18	0,152
40 T10/16-2	16	6F	Al	50,93	49,05	54	30	40	35	—	8	20	0,176
40 T10/18-2	18	6F	Al	57,29	55,45	60	30	40	40	—	8	22	0,224
40 T10/19-2	19	6F	Al	60,48	58,60	66	30	40	44	—	8	22	0,247
40 T10/20-2	20	6F	Al	63,66	61,80	66	30	40	46	—	8	24	0,276
40 T10/22-2	22	6F	Al	70,03	68,15	75	30	40	52	—	8	28	0,337
40 T10/24-2	24	6F	Al	76,39	74,55	83	30	40	58	—	8	30	0,392
40 T10/25-2	25	6F	Al	79,58	77,70	83	30	40	60	—	8	30	0,422
40 T10/26-2	26	6F	Al	82,76	80,90	87	30	40	60	—	8	30	0,477
40 T10/27-2	27	6F	Al	85,95	84,10	91	30	40	60	—	8	30	0,536
40 T10/28-2	28	6F	Al	89,13	87,25	93	30	40	60	—	8	30	0,540
40 T10/30-2	30	6F	Al	95,49	93,65	97	30	40	60	—	8	30	0,640
40 T10/32-2	32	6F	Al	101,86	100,00	106	30	40	65	—	10	32	0,693
40 T10/36-2	36	6F	Al	114,59	112,75	119	30	40	70	—	10	35	0,873
40 T10/40-2	40	6F	Al	127,32	125,45	131	30	40	80	—	10	40	1,067
40 T10/44-0	44	6	Al	140,06	138,20	—	30	40	88	—	10	46	1,350
40 T10/48-0	48	6	Al	152,78	150,95	—	30	40	95	—	16	48	1,516
40 T10/60-0	60	6	Al	190,98	189,10	—	30	40	110	—	16	60	2,339

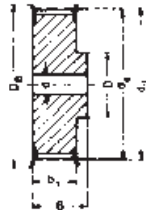

Ausf. Type 6F



Ausf. Type 6

Type T 10 – Teilung Pitch 10 mm für Riemenbreite for belt width 32 mm

Bezeichnung Part no.	Anzahl der Zähne No. of teeth	Aus- führung Type	Material	d _g (mm)	d _a (mm)	D _B (mm)	b ₁ (mm)	B (mm)	D (mm)	D _i (mm)	Vor- bohrung Pilot bore d (mm)	Fertig- bohrung Finished bore d _{max} (mm)	Gewicht Weight (≈ kg)
47 T10/18-2	18	6F	Al	57,29	55,45	60	37	47	40	—	10	22	0,253
47 T10/19-2	19	6F	Al	60,48	58,60	66	37	47	44	—	10	22	0,286
47 T10/20-2	20	6F	Al	63,66	61,80	66	37	47	46	—	12	24	0,322
47 T10/22-2	22	6F	Al	70,03	68,15	75	37	47	52	—	12	28	0,393
47 T10/24-2	24	6F	Al	76,39	74,55	83	37	47	58	—	12	30	0,475
47 T10/25-2	25	6F	Al	79,58	77,70	83	37	47	60	—	12	30	0,527
47 T10/26-2	26	6F	Al	82,76	80,90	87	37	47	60	—	12	30	0,564
47 T10/27-2	27	6F	Al	85,95	84,10	91	37	47	60	—	12	30	0,602
47 T10/28-2	28	6F	Al	89,13	87,25	93	37	47	60	—	12	30	0,642
47 T10/30-2	30	6F	Al	95,49	93,65	97	37	47	60	—	12	30	0,740
47 T10/32-2	32	6F	Al	101,86	100,00	106	37	47	65	—	12	32	0,844
47 T10/36-2	36	6F	Al	114,59	112,75	119	37	47	70	—	16	35	1,083
47 T10/40-2	40	6F	Al	127,32	125,45	131	37	47	80	—	16	40	1,317
47 T10/44-0	44	6	Al	140,06	138,20	—	37	47	88	—	16	46	1,611
47 T10/48-0	48	6	Al	152,78	150,95	—	37	47	95	—	16	48	1,931
47 T10/60-0	60	6	Al	190,98	189,10	—	37	47	110	—	16	60	3,004

Type T 10 – Teilung Pitch 10 mm für Riemenbreite for belt width 50 mm

66 T10/18-2	18	6F	Al	57,29	55,45	60	56	66	40	—	10	22	0,422
66 T10/19-2	19	6F	Al	60,48	58,60	66	56	66	44	—	10	22	0,466
66 T10/20-2	20	6F	Al	63,66	61,80	66	56	66	46	—	12	24	0,520
66 T10/22-2	22	6F	Al	70,03	68,15	75	56	66	52	—	12	28	0,570
66 T10/24-2	24	6F	Al	76,39	74,55	83	56	66	58	—	12	30	0,736
66 T10/25-2	25	6F	Al	79,58	77,70	83	56	66	60	—	12	30	0,766
66 T10/26-2	26	6F	Al	82,76	80,90	87	56	66	60	—	12	30	0,816
66 T10/27-2	27	6F	Al	85,95	84,10	91	56	66	60	—	12	30	0,946
66 T10/28-2	28	6F	Al	89,13	87,25	93	56	66	60	—	12	30	0,960
66 T10/30-2	30	6F	Al	95,49	93,65	97	56	66	60	—	12	30	1,169
66 T10/32-2	32	6F	Al	101,86	100,00	106	56	66	65	—	12	32	1,300
66 T10/36-2	36	6F	Al	114,59	112,75	119	56	66	70	—	16	35	1,637
66 T10/40-2	40	6F	Al	127,32	125,45	131	56	66	80	—	16	40	1,999
66 T10/44-0	44	6	Al	140,06	138,20	—	56	66	88	—	16	46	2,357
66 T10/48-0	48	6	Al	152,78	150,95	—	56	66	95	—	16	48	2,830
66 T10/60-0	60	6	Al	190,98	189,10	—	56	66	110	—	16	60	4,366

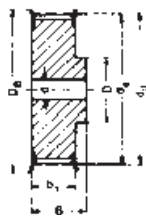

Ausf. Type 6F



Ausf. Type 6

Type AT 5 – Teilung Pitch 5 mm für Riemenbreite for belt width 10 mm

Bezeichnung Part no.	Anzahl der Zähne No. of teeth	Aus- führung Type	Material	d _d (mm)	d _a (mm)	D _B (mm)	b ₁ (mm)	B (mm)	D (mm)	Vor- bohrung Pilot bore d (mm)	Fertig- bohrung Finished bore d _{max} (mm)	Gewicht Weight (≈ kg)
21 AT 5/12-2	12	6F	Al	19,01	17,85	23,0	15	21	10	—	6	0,016
21 AT 5/14-2	14	6F	Al	22,29	21,05	25,0	15	21	13	—	8	0,019
21 AT 5/15-2	15	6F	Al	23,88	22,65	28,0	15	21	16	6	10	0,021
21 AT 5/16-2	16	6F	Al	25,47	24,20	32,0	15	21	18	6	11	0,025
21 AT 5/18-2	18	6F	Al	28,65	27,40	32,0	15	21	19	6	12	0,031
21 AT 5/19-2	19	6F	Al	30,25	29,00	36,0	15	21	22	6	12	0,036
21 AT 5/20-2	20	6F	Al	31,83	30,60	36,0	15	21	23	6	14	0,038
21 AT 5/22-2	22	6F	Al	35,12	33,85	38,0	15	21	24	6	15	0,046
21 AT 5/24-2	24	6F	Al	38,21	37,00	42,0	15	21	26	6	15	0,054
21 AT 5/25-2	25	6F	Al	39,80	38,60	44,0	15	21	26	6	15	0,058
21 AT 5/26-2	26	6F	Al	41,47	40,20	44,0	15	21	26	6	16	0,062
21 AT 5/27-2	27	6F	Al	42,98	41,80	48,0	15	21	30	8	18	0,064
21 AT 5/28-2	28	6F	Al	44,62	43,35	48,0	15	21	32	8	18	0,071
21 AT 5/30-2	30	6F	Al	47,76	46,55	51,0	15	21	34	8	18	0,075
21 AT 5/32-2	32	6F	Al	50,94	49,70	54,0	15	21	38	8	22	0,088
21 AT 5/36-2	36	6F	Al	57,31	56,05	63,0	15	21	38	8	22	0,114
21 AT 5/40-2	40	6F	Al	63,66	62,45	66,0	15	21	40	8	23	0,138
21 AT 5/42-2	42	6F	Al	66,87	65,60	71,0	15	21	40	8	24	0,180
21 AT 5/44-0	44	6	Al	70,07	68,80	—	15	21	45	8	26	0,185
21 AT 5/48-0	48	6	Al	76,42	75,15	—	15	21	50	8	28	0,200
21 AT 5/60-0	60	6	Al	95,52	94,25	—	15	21	65	8	35	0,307

Type AT 5 – Teilung Pitch 5 mm für Riemenbreite for belt width 16 mm

27 AT 5/12-2	12	6F	Al	19,01	17,85	23,0	21	27	10	—	6	0,022
27 AT 5/14-2	14	6F	Al	22,29	21,05	25,0	21	27	13	—	8	0,026
27 AT 5/15-2	15	6F	Al	23,88	22,65	28,0	21	27	16	6	10	0,029
27 AT 5/16-2	16	6F	Al	25,47	24,20	32,0	21	27	18	6	11	0,035
27 AT 5/18-2	18	6F	Al	28,65	27,40	32,0	21	27	19	6	12	0,043
27 AT 5/19-2	19	6F	Al	30,25	29,00	36,0	21	27	22	6	12	0,049
27 AT 5/20-2	20	6F	Al	31,83	30,60	36,0	21	27	23	6	14	0,053
27 AT 5/22-2	22	6F	Al	35,12	33,85	38,0	21	27	24	6	15	0,054
27 AT 5/24-2	24	6F	Al	38,21	37,00	42,0	21	27	26	6	15	0,076
27 AT 5/25-2	25	6F	Al	39,80	38,60	44,0	21	27	26	6	15	0,081
27 AT 5/26-2	26	6F	Al	41,47	40,20	44,0	21	27	26	6	16	0,085
27 AT 5/27-2	27	6F	Al	42,98	41,80	48,0	21	27	30	8	18	0,090
27 AT 5/28-2	28	6F	Al	44,62	43,35	48,0	21	27	32	8	18	0,092
27 AT 5/30-2	30	6F	Al	47,76	46,55	51,0	21	27	34	8	18	0,105
27 AT 5/32-2	32	6F	Al	50,94	49,70	54,0	21	27	38	8	22	0,123
27 AT 5/36-2	36	6F	Al	57,31	56,05	63,0	21	27	38	8	22	0,160
27 AT 5/40-2	40	6F	Al	63,66	62,45	66,0	21	27	40	8	23	0,193
27 AT 5/42-2	42	6F	Al	66,87	65,60	71,0	21	27	40	8	24	0,205
27 AT 5/44-0	44	6	Al	70,07	68,80	—	21	27	45	8	26	0,228
27 AT 5/48-0	48	6	Al	76,42	75,15	—	21	27	50	8	28	0,280
27 AT 5/60-0	60	6	Al	95,52	94,25	—	21	27	65	8	35	0,430

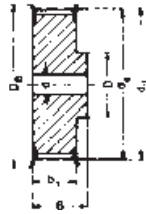

Ausf. Type 6F



Ausf. Type 6

Type AT 5 – Teilung Pitch 5 mm für Riemenbreite for belt width 25 mm

Bezeichnung Part no.	Anzahl der Zähne No. of teeth	Aus- führung Type	Material	d_d (mm)	d_a (mm)	D_B (mm)	b_1 (mm)	B (mm)	D (mm)	Vor- bohrung Pilot bore d (mm)	Fertig- bohrung Finished bore d_{max} (mm)	Gewicht Weight (= kg)
36 AT 5/12-2	12	6F	Al	19,01	17,85	23,0	30	36	10	—	6	0,031
36 AT 5/14-2	14	6F	Al	22,29	21,05	25,0	30	36	13	—	8	0,037
36 AT 5/15-2	15	6F	Al	23,88	22,65	28,0	30	36	16	6	10	0,041
36 AT 5/16-2	16	6F	Al	25,47	24,20	32,0	30	36	18	6	11	0,050
36 AT 5/18-2	18	6F	Al	28,65	27,40	32,0	30	36	19	6	12	0,061
36 AT 5/19-2	19	6F	Al	30,25	29,00	36,0	30	36	22	6	12	0,070
36 AT 5/20-2	20	6F	Al	31,83	30,60	36,0	30	36	23	6	14	0,076
36 AT 5/22-2	22	6F	Al	35,12	33,85	38,0	30	36	24	6	15	0,080
36 AT 5/24-2	24	6F	Al	38,21	37,00	42,0	30	36	26	8	15	0,109
36 AT 5/25-2	25	6F	Al	39,80	38,60	44,0	30	36	26	8	15	0,116
36 AT 5/26-2	26	6F	Al	41,47	40,20	44,0	30	36	26	8	16	0,120
36 AT 5/27-2	27	6F	Al	42,98	41,80	48,0	30	36	30	8	18	0,128
36 AT 5/28-2	28	6F	Al	44,62	43,35	48,0	30	36	32	8	18	0,135
36 AT 5/30-2	30	6F	Al	47,76	46,55	51,0	30	36	34	8	18	0,150
36 AT 5/32-2	32	6F	Al	50,94	49,70	54,0	30	36	38	8	22	0,176
36 AT 5/36-2	36	6F	Al	57,31	56,05	63,0	30	36	38	8	22	0,230
36 AT 5/40-2	40	6F	Al	63,66	62,45	66,0	30	36	40	8	23	0,276
36 AT 5/42-2	42	6F	Al	66,87	65,60	71,0	30	36	40	8	24	0,284
36 AT 5/44-0	44	6	Al	70,07	68,80	—	30	36	45	8	26	0,315
36 AT 5/48-0	48	6	Al	76,42	75,15	—	30	36	50	8	28	0,400
36 AT 5/60-0	60	6	Al	95,52	94,25	—	30	36	65	8	35	0,614

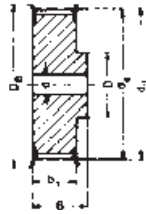

Ausf. Type 6F



Ausf. Type 6

Type AT 10 – Teilung Pitch 10 mm für Riemenbreite for belt width 16 mm

Bezeichnung Part no.	Anzahl der Zähne No. of teeth	Aus- führung Type	Material	d _d (mm)	d _a (mm)	D _B (mm)	b ₁ (mm)	B (mm)	D (mm)	Vor- bohrung Pilot bore d (mm)	Fertig- bohrung Finished bore d _{max} (mm)	Gewicht Weight (≈ kg)
31 AT 10/15-2	15	6F	Al	47,75	45,90	51	21	31	32	8	18	0,116
31 AT 10/16-2	16	6F	Al	50,93	49,05	54	21	31	35	8	20	0,134
31 AT 10/18-2	18	6F	Al	57,29	55,45	60	21	31	40	8	22	0,167
31 AT 10/19-2	19	6F	Al	60,48	58,60	66	21	31	44	8	22	0,184
31 AT 10/20-2	20	6F	Al	63,66	61,80	66	21	31	46	8	24	0,208
31 AT 10/22-2	22	6F	Al	70,03	68,15	75	21	31	52	8	28	0,253
31 AT 10/24-2	24	6F	Al	76,39	74,55	83	21	31	58	8	30	0,288
31 AT 10/25-2	25	6F	Al	79,58	77,70	83	21	31	60	8	30	0,310
31 AT 10/26-2	26	6F	Al	82,76	80,90	87	21	31	60	8	30	0,357
31 AT 10/27-2	27	6F	Al	85,95	84,10	91	21	31	60	8	30	0,364
31 AT 10/28-2	28	6F	Al	89,13	87,25	93	21	31	60	8	30	0,401
31 AT 10/30-2	30	6F	Al	95,49	93,65	97	21	31	60	8	30	0,441
31 AT 10/32-2	32	6F	Al	101,86	100,00	106	21	31	65	10	32	0,493
31 AT 10/36-2	36	6F	Al	114,59	112,75	119	21	31	70	10	35	0,623
31 AT 10/40-2	40	6F	Al	127,32	125,45	131	21	31	80	10	40	0,767
31 AT 10/44-0	44	6	Al	140,06	138,20	—	21	31	88	10	46	0,993
31 AT 10/48-0	48	6	Al	152,78	150,95	—	21	31	95	16	48	1,090
31 AT 10/60-0	60	6	Al	190,98	189,10	—	21	31	110	16	60	1,710

Type AT 10 – Teilung Pitch 10 mm für Riemenbreite for belt width 25 mm

40 AT 10/15-2	15	6F	Al	47,75	45,90	51	30	40	32	8	18	0,152
40 AT 10/16-2	16	6F	Al	50,93	49,05	54	30	40	35	8	20	0,176
40 AT 10/18-2	18	6F	Al	57,29	55,45	60	30	40	40	8	22	0,224
40 AT 10/19-2	19	6F	Al	60,48	58,60	66	30	40	44	8	22	0,247
40 AT 10/20-2	20	6F	Al	63,66	61,80	66	30	40	46	8	24	0,276
40 AT 10/22-2	22	6F	Al	70,03	68,15	75	30	40	52	8	28	0,337
40 AT 10/24-2	24	6F	Al	76,39	74,55	83	30	40	58	8	30	0,392
40 AT 10/25-2	25	6F	Al	79,58	77,70	83	30	40	60	8	30	0,422
40 AT 10/26-2	26	6F	Al	82,76	80,90	87	30	40	60	8	30	0,477
40 AT 10/27-2	27	6F	Al	85,95	84,10	91	30	40	60	8	30	0,536
40 AT 10/28-2	28	6F	Al	89,13	87,25	93	30	40	60	8	30	0,540
40 AT 10/30-2	30	6F	Al	95,49	93,65	97	30	40	60	8	30	0,640
40 AT 10/32-2	32	6F	Al	101,86	100,00	106	30	40	65	10	32	0,693
40 AT 10/36-2	36	6F	Al	114,59	112,75	119	30	40	70	10	35	0,873
40 AT 10/40-2	40	6F	Al	127,32	125,45	131	30	40	80	10	40	1,067
40 AT 10/44-0	44	6	Al	140,06	138,20	—	30	40	88	10	46	1,350
40 AT 10/48-0	48	6	Al	152,78	150,95	—	30	40	95	16	48	1,516
40 AT 10/60-0	60	6	Al	190,98	189,10	—	30	40	110	16	60	2,339

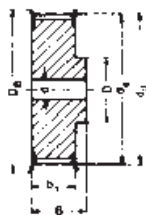

Ausf. Type 6F



Ausf. Type 6

Type AT 10 – Teilung Pitch 10 mm für Riemenbreite for belt width 32 mm

Bezeichnung Part no.	Anzahl der Zähne No. of teeth	Aus- führung Type	Material	d _d (mm)	d _a (mm)	D _B (mm)	b ₁ (mm)	B (mm)	D (mm)	Vor- bohrung Pilot bore d (mm)	Fertig- bohrung Finished bore d _{max} (mm)	Gewicht Weight (= kg)
47 AT 10/18-2	18	6F	Al	57,29	55,45	60	37	47	40	10	22	0,253
47 AT 10/19-2	19	6F	Al	60,48	58,60	66	37	47	44	10	22	0,286
47 AT 10/20-2	20	6F	Al	63,66	61,80	66	37	47	46	12	24	0,322
47 AT 10/22-2	22	6F	Al	70,03	68,15	75	37	47	52	12	28	0,393
47 AT 10/24-2	24	6F	Al	76,39	74,55	83	37	47	58	12	30	0,475
47 AT 10/25-2	25	6F	Al	79,58	77,70	83	37	47	60	12	30	0,527
47 AT 10/26-2	26	6F	Al	82,76	80,90	87	37	47	60	12	30	0,564
47 AT 10/27-2	27	6F	Al	85,95	84,10	91	37	47	60	12	30	0,602
47 AT 10/28-2	28	6F	Al	89,13	87,25	93	37	47	60	12	30	0,642
47 AT 10/30-2	30	6F	Al	95,49	93,65	97	37	47	60	12	30	0,740
47 AT 10/32-2	32	6F	Al	101,86	100,00	106	37	47	65	12	32	0,844
47 AT 10/36-2	36	6F	Al	114,59	112,75	119	37	47	70	16	35	1,083
47 AT 10/40-2	40	6F	Al	127,32	125,45	131	37	47	80	16	40	1,317
47 AT 10/44-0	44	6	Al	140,06	138,20	—	37	47	88	16	46	1,611
47 AT 10/48-0	48	6	Al	152,78	150,95	—	37	47	95	16	48	1,931
47 AT 10/60-0	60	6	Al	190,98	189,10	—	37	47	110	16	60	3,004

Type AT 10 – Teilung Pitch 10 mm für Riemenbreite for belt width 50 mm

66 AT 10/18-2	18	6F	Al	57,29	55,45	60	56	66	40	10	22	0,422
66 AT 10/19-2	19	6F	Al	60,48	58,60	66	56	66	44	10	22	0,466
66 AT 10/20-2	20	6F	Al	63,66	61,80	66	56	66	46	12	24	0,520
66 AT 10/22-2	22	6F	Al	70,03	68,15	75	56	66	52	12	28	0,570
66 AT 10/24-2	24	6F	Al	76,39	74,55	83	56	66	58	12	30	0,736
66 AT 10/25-2	25	6F	Al	79,58	77,70	83	56	66	60	12	30	0,766
66 AT 10/26-2	26	6F	Al	82,76	80,90	87	56	66	60	12	30	0,816
66 AT 10/27-2	27	6F	Al	85,95	84,10	91	56	66	60	12	30	0,946
66 AT 10/28-2	28	6F	Al	89,13	87,25	93	56	66	60	12	30	0,960
66 AT 10/30-2	30	6F	Al	95,49	93,65	97	56	66	60	12	30	1,169
66 AT 10/32-2	32	6F	Al	101,86	100,00	106	56	66	65	12	32	1,300
66 AT 10/36-2	36	6F	Al	114,59	112,75	119	56	66	70	16	35	1,637
66 AT 10/40-2	40	6F	Al	127,32	125,45	131	56	66	80	16	40	1,999
66 AT 10/44-0	44	6	Al	140,06	138,20	—	56	66	88	16	46	2,357
66 AT 10/48-0	48	6	Al	152,78	150,95	—	56	66	95	16	48	2,830
66 AT 10/60-0	60	6	Al	190,98	189,10	—	56	66	110	16	60	4,366

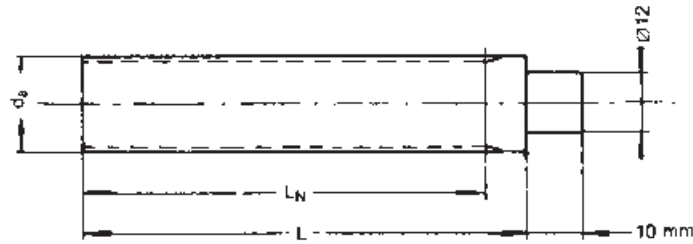

Type XL – Teilung Pitch 5,08 mm (1/5")

Bezeichnung Part no.	Anzahl der Zähne No. of teeth	Material	d _g (mm)	d _a (mm)	L _N (mm)	L (mm)
10 XL 125	10	St	16,17	15,66	125	140
11 XL 125	11	St	17,79	17,28	125	140
12 XL 125	12	St	19,40	18,89	125	140
13 XL 125	13	St	21,02	20,51	125	140
14 XL 132	14	St	22,64	22,13	132	140
15 XL 132	15	St	24,26	23,75	132	140
16 XL 140	16	St	25,87	25,36	140	140
17 XL 140	17	St	27,49	26,98	140	140
18 XL 140	18	St	29,11	28,60	140	140
19 XL 140	19	St	30,72	30,21	140	140
20 XL 140	20	St	32,34	31,83	140	140
21 XL 160	21	St	33,96	33,45	160	160
22 XL 160	22	St	35,57	35,06	160	160
23 XL 160	23	St	37,19	36,68	160	160
24 XL 160	24	St	38,81	38,30	160	160
25 XL 160	25	St	40,43	39,92	160	160
26 XL 160	26	St	42,04	41,53	160	160
27 XL 160	27	St	43,66	43,15	160	160
28 XL 160	28	St	45,28	44,77	160	160
29 XL 160	29	St	46,89	46,38	160	160
30 XL 160	30	St	48,51	48,00	160	160
32 XL 160	32	Al	51,74	51,23	160	160
33 XL 160	33	Al	53,36	52,76	160	160
34 XL 160	34	Al	54,98	54,47	160	160
35 XL 160	35	Al	56,60	56,09	160	160
36 XL 160	36	Al	58,21	57,70	160	160
38 XL 160	38	Al	61,45	60,94	160	160
39 XL 160	39	Al	63,06	62,55	160	160
40 XL 160	40	Al	64,68	64,17	160	160
41 XL 160	41	Al	66,30	65,79	160	160
42 XL 160	42	Al	67,91	67,40	160	160
43 XL 160	43	Al	69,53	69,02	160	160
44 XL 160	44	Al	71,15	70,64	160	160
48 XL 160	48	Al	77,62	77,11	160	160
56 XL 160	56	Al	90,55	90,04	160	160
60 XL 160	60	Al	97,02	96,51	160	160
72 XL 160	72	Al	116,43	115,92	160	160

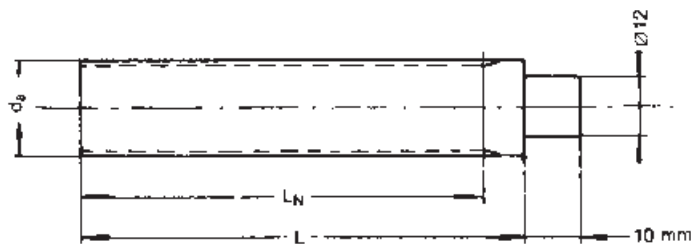

Type L – Teilung *Pitch* 9,525 mm ($\frac{3}{8}$ ")

Bezeichnung Part no.	Anzahl der Zähne No. of teeth	Material	d_g (mm)	d_a (mm)	L_N (mm)	L (mm)
10 L 140	10	St	30,32	29,56	140	140
11 L 140	11	St	33,35	32,59	140	140
12 L 160	12	St	36,38	35,62	160	160
13 L 160	13	St	39,41	38,65	160	160
14 L 160	14	St	42,45	41,68	160	160
15 L 160	15	St	45,48	44,72	160	160
16 L 160	16	St	48,51	47,75	160	160
17 L 160	17	St	51,54	50,78	160	160
18 L 160	18	St	54,57	53,81	160	160
19 L 160	19	St	57,61	56,84	160	160
20 L 160	20	St	60,64	59,88	160	160
21 L 160	21	St	63,67	62,91	160	160
22 L 160	22	St	66,70	65,94	160	160
23 L 160	23	St	69,73	68,97	160	160
24 L 160	24	St	72,77	72,00	160	160
27 L 160	27	St	81,86	81,10	160	160
30 L 160	30	St	90,96	90,20	160	160

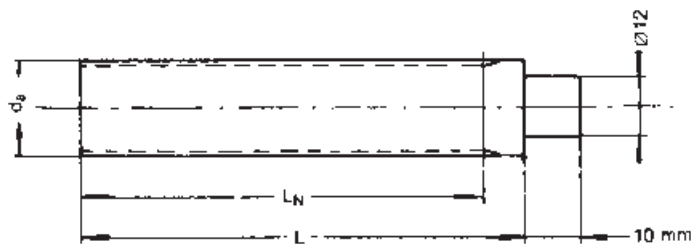

Type T 5 – Teilung Pitch 5 mm

Bezeichnung Part no.	Anzahl der Zähne No. of teeth	Material	d _d (mm)	d _a (mm)	L _N (mm)	L (mm)
125 T 5- 10	10	Al	15,92	15,05	125	140
125 T 5- 11	11	Al	17,51	16,65	125	140
125 T 5- 12	12	Al	19,01	18,25	125	140
125 T 5- 13	13	Al	20,70	19,85	125	140
132 T 5- 14	14	Al	22,29	21,45	132	140
132 T 5- 15	15	Al	23,88	23,05	132	140
140 T 5- 16	16	Al	25,47	24,60	140	140
140 T 5- 17	17	Al	27,06	26,20	140	140
140 T 5- 18	18	Al	28,65	27,80	140	140
140 T 5- 19	19	Al	30,25	29,40	140	140
160 T 5- 20	20	Al	31,83	31,00	160	160
160 T 5- 21	21	Al	33,43	32,70	160	160
160 T 5- 22	22	Al	35,12	34,25	160	160
160 T 5- 23	23	Al	36,62	35,85	160	160
160 T 5- 24	24	Al	38,21	37,40	160	160
160 T 5- 25	25	Al	39,80	39,00	160	160
160 T 5- 26	26	Al	41,47	40,60	160	160
160 T 5- 27	27	Al	42,98	42,20	160	160
160 T 5- 28	28	Al	44,62	43,75	160	160
160 T 5- 29	29	Al	46,17	45,35	160	160
160 T 5- 30	30	Al	47,76	46,95	160	160
160 T 5- 32	32	Al	50,94	50,10	160	160
160 T 5- 34	34	Al	54,13	53,25	160	160
160 T 5- 35	35	Al	55,72	54,85	160	160
160 T 5- 36	36	Al	57,31	56,45	160	160
160 T 5- 37	37	Al	58,90	58,06	160	160
160 T 5- 38	38	Al	60,50	59,65	160	160
160 T 5- 40	40	Al	63,66	62,85	160	160
160 T 5- 42	42	Al	66,87	66,00	160	160
160 T 5- 44	44	Al	70,07	69,20	160	160
160 T 5- 45	45	Al	71,64	70,80	160	160
160 T 5- 46	46	Al	73,23	72,40	160	160
160 T 5- 48	48	Al	76,42	75,55	160	160
160 T 5- 50	50	Al	79,60	78,75	160	160
160 T 5- 60	60	Al	95,52	94,65	160	160
160 T 5- 72	72	Al	114,62	113,75	160	160
160 T 5- 80	80	Al	127,36	126,48	160	160
160 T 5- 90	90	Al	143,28	142,40	160	160
160 T 5-100	100	Al	159,20	158,31	160	160

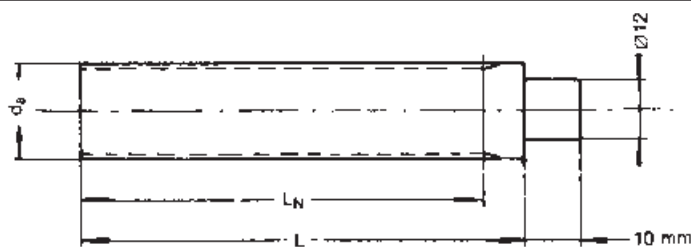

Type T 10 – Teilung Pitch 10 mm

Bezeichnung Part no.	Anzahl der Zähne No. of teeth	Material	d_g (mm)	d_a (mm)	L_N (mm)	L (mm)
140 T 10-10	10	Al	31,83	29,98	140	140
140 T 10-11	11	Al	35,01	33,16	140	140
140 T 10-12	12	Al	38,20	36,35	140	140
140 T 10-13	13	Al	41,38	39,50	140	140
160 T 10-14	14	Al	44,56	42,70	160	160
160 T 10-15	15	Al	47,75	45,90	160	160
160 T 10-16	16	Al	50,93	49,05	160	160
160 T 10-17	17	Al	54,11	52,25	160	160
160 T 10-18	18	Al	57,29	55,45	160	160
160 T 10-19	19	Al	60,48	58,60	160	160
160 T 10-20	20	Al	63,66	61,60	160	160
160 T 10-21	21	Al	66,84	65,00	160	160
160 T 10-22	22	Al	70,03	68,15	160	160
160 T 10-23	23	Al	73,20	71,35	160	160
160 T 10-24	24	Al	76,39	74,55	160	160
160 T 10-26	26	Al	82,76	80,90	160	160
160 T 10-28	28	Al	89,13	87,25	160	160
160 T 10-30	30	Al	95,49	93,65	160	160
160 T 10-32	32	Al	101,86	100,00	160	160
160 T 10-34	34	Al	108,22	106,40	160	160
160 T 10-36	36	Al	114,59	112,75	160	160
160 T 10-38	38	Al	120,95	119,10	160	160
160 T 10-40	40	Al	127,32	125,45	160	160
160 T 10-45	45	Al	143,24	141,40	160	160
160 T 10-48	48	Al	152,78	150,95	160	160
160 T 10-60	60	Al	190,98	189,10	160	160
160 T 10-72	72	Al	229,18	227,29	160	160



optibelt TN Anschraubnaben – Bolt on hubs												
Bezeichnung Part no.	Material	Taper- Buchse Taper bush	D _A (mm)	D _T (mm)	D + 0/- 0,1 (mm)	D _K (mm)	B (mm)	b (mm)	Z (mm)	B _M (mm)	d (mm)	Gewicht o. Buchse Weight without bush (≈ kg)
SM 12	GG	1210	180	135	90	75	25	6,5	2,5	11,5	6 x 7,5	1,5
SM 16	GG	1615	200	150	110	85	38	7,5	2,5	12,5	6 x 7,5	3,0
SM 20	GG	2012	270	190	140	110	32	8,5	2,5	13,5	6 x 9,5	
SM 25	GG	2517	340	240	170	125	45	9,5	2,5	14,5	8 x 11,5	7,6
SM 30-1	GG	3020	430	300	220	160	51	13,5	2,5	18,5	8 x 13,5	16,6
SM 30-2	GG	3020	485	340	250	160	51	13,5	2,5	18,5	8 x 13,5	20,5

optibelt TN Einschweißnaben Type WM – Weld on hubs type WM										
Bezeichnung Part no.	Material	Taper- Buchse Taper bush	D _A (mm)	D + 0/- 0,05 (mm)	D _K (mm)	B + 0,5/- 0,05 (mm)	b ₁ (mm)	b ₂ (mm)	Gewicht ohne Buchse Weight without bush (≈ kg)	
WM 1210	St	1210	70	60	58	25	9	10	0,3	
WM 1615	St	1615	83	70	68	38	16	11	0,6	
WM 2012	St	2012	95	90	88	32	12	12	0,7	
WM 2517	St	2517	127	110	108	44	19	13	1,8	
WM 3030	St	3030	152	130	125	76	25	19	3,5	
WM 3535	St	3535	184	155	151	89	32	25	10,0	
WM 4040	St	4040	225	195	187	102	32	32	13,2	
WM 4545	St	4545	254	220	213	115	38	38	20,1	
WM 5050	St	5050	276	242	228	127	38	38	25,4	

optibelt TN Einschweißnaben Type WH – Weld on hubs type WH										
Bezeichnung Part no.	Material	Taper- Buchse Taper bush	D _A (mm)	D + 0/- 0,05 (mm)	D _K (mm)	B + 0,5/- 0,05 (mm)	b ₁ (mm)	b ₂ (mm)	Gewicht ohne Buchse Weight without bush (≈ kg)	
WH 1210	St	1210	70	65	64,5	25	9	10	0,3	
WH 1610	St	1610	80	75	74,5	25	9	10		
WH 2012	St	2012	95	90	89,5	32	12	12		
WH 2517	St	2517	115	110	109,5	44	19	15		
WH 3020	St	3020	145	140	139,5	50	19	15	2,7	
WH 3525	St	3525	190	180	179,5	65	25	25		
WH 3535	St	3535	190	180	179,5	89	32	25	10,0	
WH 4040	St	4040	200	190	189,5	101	32	30		
WH 4545	St	4545	210	200	199,5	115	40	30		
WH 5050	St	5050	230	220	219,5	127	40	35		

Taper-Buchse Taper bush	1210	1610	1615	2012	2517	3020	3030	3525	3535	4040	4545	5050
Bohrung d ₂ (mm) von ... bis ... Bore d ₂ (mm) from ... to ...	11-32	14-42	14-42	14-50	16-60	25-75	35-75	35-90	35-90	40-100	44-110	70-125

Bohrungsdurchmesser d₂ siehe Seite 89.
Bore diameters d₂ see page 89.

Weitere Abmessungen auf Anfrage.
Further sizes on request.

GG = Grauguss
GG = Cast iron

St = Stahl
St = Steel

Fertigungstechnische Änderungen vorbehalten.
We reserve the right to make technical changes.

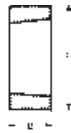

Bezeichnung Part No.	Material	Taper- Buchse Taper bush	D (mm)	B (mm)	Nut- querschnitt Keyway dimensions b x h (mm)	minimaler Nabendurchmesser der Scheibe Minimum hub diameter			Gewicht ohne Buchse Weight without bush (≈ kg)
						Material			
						GG	GGG	St	
1008 AM 1008 BM	St St	1008 1008	45 45	22 22	5 x 2,5	71 75	62 67	56 60	0,1 0,1
1210 AM 1210 BM	St St	1210 1210	60 60	25 25	6 x 3	86 92	79 86	73 83	0,2 0,2
1610 AM 1610 BM	St St	1610 1610	70 70	25 25	10 x 4	95 102	89 95	83 89	0,3 0,3
1615 AM 1615 BM	St St	1615 1615	70 70	38 38	10 x 4	95 102	89 95	83 89	0,4 0,4
2517 AM 2517 BM	St St	2517 2517	105 105	45 45	16 x 4	143 149	133 140	121 127	1,0 1,0
3030 AM 3030 BM	St St	3030 3030	130 130	76 76	20 x 5	178 187	165 175	156 159	2,5 2,5
3535 AM 3535 BM	St St	3535 3535	160 160	89 89	22 x 5	222 232	203 213	191 200	5,2 5,2
4040 AM 4040 BM	St St	4040 4040	185 185	102 102	24 x 5	273 283	248 257	229 238	8,0 8,0

St = Stahl Steel GG = Grauguss Cast iron GGG = Globularer Grauguss Spheroidal graphite cast iron AM = ohne Keilnut without keyway BM = mit Keilnut with keyway

Taper-Buchse Taper bush	1008	1210	1610	1615	2517	3030	3535	4040
Bohrung d ₂ (mm) von ... bis ... Bore d ₂ (mm) from ... to ...	10-25	11-32	14-42	14-42	16-60	35-75	35-90	40-100

Bohrungsdurchmesser d₂ siehe Seite 89. Bore diameters d₂ see page 89. Weitere Abmessungen auf Anfrage. Further sizes on request. Fertigungstechnische Änderungen vorbehalten. We reserve the right to make technical changes.

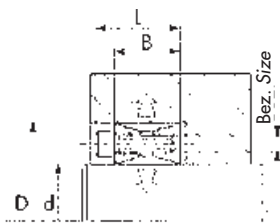

Type CE01

Bezeichnung Part no.	Abmessung Dimension				Schrauben Screws			Bei Anzugsmoment M _s übertragbar With tightening torque M _s applied		Flächen- pressung Pressure		Gewicht Weight
								Drehmoment Torque	Axialkraft Axial force	Welle Shaft	Nabe Hub	
	d	D	B	L	Bezeichnung Part no.	Anzahl No.	Anzugs- moment Tightening torque M _s	M	F	P _w	P _N	
	(mm)	(mm)	(mm)	(mm)		Stück Each	(N _m)	(N _m)	(K _N)	(N/ mm ²)	(N/ mm ²)	
CE01- 18	18	47	20	26	M 6 x 18	8	16	250	28	240	92	0,210
CE01- 19	19	47	20	26	M 6 x 18	8	16	260	28	225	92	0,210
CE01- 20	20	47	20	26	M 6 x 18	8	16	280	28	215	92	0,210
CE01- 22	22	47	20	26	M 6 x 18	8	16	310	28	195	92	0,200
CE01- 24	24	50	20	26	M 6 x 18	8	16	330	28	180	87	0,222
CE01- 25	25	50	20	26	M 6 x 18	8	16	350	28	175	87	0,220
CE01- 28	28	55	20	26	M 6 x 18	12	16	580	42	230	118	0,266
CE01- 30	30	55	20	26	M 6 x 18	12	16	630	42	215	118	0,254
CE01- 32	32	60	20	26	M 6 x 18	12	16	670	42	200	110	0,302
CE01- 35	35	60	20	26	M 6 x 18	12	16	730	42	185	110	0,282
CE01- 38	38	65	20	26	M 6 x 18	15	16	990	52	215	125	0,328
CE01- 40	40	65	20	26	M 6 x 18	15	16	1040	52	200	125	0,318
CE01- 42	42	75	24	32	M 8 x 22	12	38	1600	76	240	140	0,560
CE01- 45	45	75	24	32	M 8 x 22	12	38	1700	76	225	140	0,528
CE01- 48	48	80	24	32	M 8 x 22	12	38	1800	76	210	120	0,590
CE01- 50	50	80	24	32	M 8 x 22	12	38	1900	76	200	130	0,560
CE01- 55	55	85	24	32	M 8 x 22	15	38	2600	95	230	150	0,622
CE01- 60	60	90	24	32	M 8 x 22	15	38	2850	95	210	140	0,660
CE01- 65	65	95	24	32	M 8 x 22	15	38	3100	95	195	130	0,798
CE01- 70	70	110	28	38	M10 x 25	15	75	5350	150	240	160	1,238
CE01- 75	75	115	28	38	M10 x 25	15	75	5730	150	225	150	1,294
CE01- 80	80	120	28	38	M10 x 25	15	75	6100	150	210	140	1,364
CE01- 85	85	125	28	38	M10 x 25	15	75	6500	150	200	140	1,428
CE01- 90	90	130	28	38	M10 x 25	15	75	6900	150	185	130	1,482
CE01- 95	95	135	28	38	M10 x 25	18	75	8700	180	210	150	1,568
CE01-100	100	145	30	42	M12 x 30	15	130	11200	220	230	160	2,154
CE01-110	110	155	30	42	M12 x 30	15	130	12300	220	205	150	2,306
CE01-120	120	165	30	42	M12 x 30	16	130	14300	240	200	150	2,486
CE01-130	130	180	38	50	M12 x 35	20	130	19400	300	180	130	3,586
CE01-140	140	190	38	50	M12 x 35	22	130	23000	330	180	140	3,810
CE01-150	150	200	38	50	M12 x 35	24	130	26900	360	185	140	4,084
CE01-160	160	210	38	50	M12 x 35	26	130	31000	390	190	150	4,360
CE01-170	170	225	44	58	M14 x 40	22	200	36300	430	175	140	5,700
CE01-180	180	235	44	58	M14 x 40	24	200	42000	470	180	140	6,000
CE01-190	190	250	52	66	M14 x 45	28	200	51800	550	165	130	8,000
CE01-200	200	260	52	66	M14 x 45	30	200	58300	590	165	130	8,200
CE01-220*	220	285	56	72	M16 x 50	26	300	74100	680	160	130	11,000
CE01-240*	240	305	56	72	M16 x 50	30	300	93200	780	170	140	12,300
CE01-260*	260	325	56	72	M16 x 50	34	300	114500	890	180	150	13,000
CE01-280*	280	355	66	84	M18 x 60	32	410	141000	1000	160	130	19,000
CE01-300*	300	375	66	84	M18 x 60	36	410	170000	1140	165	140	20,200
CE01-320*	320	405	78	98	M20 x 70	36	590	235500	1500	170	140	30,600
CE01-340*	340	425	78	98	M20 x 70	36	590	250000	1500	160	130	30,800
CE01-360*	360	455	90	112	M22 x 80	36	790	329000	1800	160	130	43,200
CE01-380*	380	475	90	112	M22 x 80	36	790	346400	1800	150	120	45,000
CE01-400*	400	495	90	112	M22 x 80	36	790	365000	1800	145	120	46,800

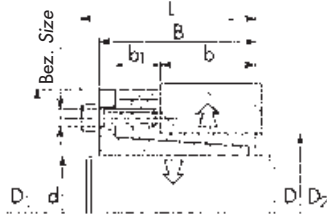

Type CE02

Bezeichnung Part no.	Abmessung Dimension								Schrauben Screws			Bei Anzugsmoment M _s übertragbar With tightening torque M _s applied		Flächen- pressung Pressure		Gewicht Weight		
	d	D	D ₁	D ₂	b	b ₁	B	L	Bezeichnung Part no.	Anzahl No.	Anzugs- moment Tightening torque M _s	Drehmoment Torque	Axialkraft Axial force	Welle Shaft	Nabe Hub			
												M	F				P _W	P _N
												(N _m)	(K _N)				(N/ mm ²)	(N/ mm ²)
(mm)	(mm)	(mm)	(mm)	(mm)	(mm)	(mm)	(mm)		Stück Each	(N _m)	(K _N)	(N/ mm ²)	(N/ mm ²)	(kg)				
CE02- 6*	6	14	25	23	9	9,5	21,5	24,5	M 3 x 10	4	2	14	4,8	103	95	0,080		
CE02- 8*	8	15	27	24	12	10,0	25,0	29,0	M 4 x 10	3	5	28	7,0	104	101	0,100		
CE02- 10*	10	16	29	26	14	8,5	26,0	30,0	M 4 x 10	4	5	46	9,0	110	108	0,120		
CE02- 12	12	18	32	28	14	8,5	26,0	30,0	M 4 x 10	4	5	55	9,0	88	96	0,140		
CE02- 14	14	23	38	33	14	8,5	26,0	30,0	M 4 x 10	4	5	64	9,0	75	75	0,150		
CE02- 15	15	24	45	40	16	12,5	36,0	42,0	M 6 x 16	4	15	150	19,0	102	132	0,209		
CE02- 16	16	24	45	40	16	12,5	36,0	42,0	M 6 x 16	4	15	150	19,0	96	132	0,218		
CE02- 18	18	26	47	43	18	13,0	38,0	44,0	M 6 x 18	4	17	200	23,0	102	129	0,226		
CE02- 19	19	27	49	44	18	13,0	38,0	44,0	M 6 x 18	4	17	210	23,0	97	125	0,248		
CE02- 20	20	28	49	44	18	13,0	38,0	44,0	M 6 x 18	4	17	220	23,0	92	120	0,248		
CE02- 22	22	32	54	49	25	13,0	45,0	51,0	M 6 x 18	4	17	250	23,0	69	76	0,325		
CE02- 24	24	34	56	51	25	13,0	45,0	51,0	M 6 x 18	4	17	270	23,0	63	71	0,344		
CE02- 25	25	34	56	51	25	13,0	45,0	51,0	M 6 x 18	4	17	280	23,0	61	71	0,332		
CE02- 28	28	39	61	56	25	13,0	45,0	51,0	M 6 x 18	6	17	500	34,0	81	93	0,410		
CE02- 30	30	41	62	57	25	13,0	45,0	51,0	M 6 x 18	6	17	520	34,0	76	89	0,414		
CE02- 32	32	43	65	59	30	13,0	50,0	56,0	M 6 x 18	8	17	730	46,0	84	94	0,478		
CE02- 35	35	47	69	64	30	13,0	50,0	56,0	M 6 x 18	8	17	800	46,0	77	86	0,546		
CE02- 38	38	50	72	67	30	13,0	50,0	56,0	M 6 x 18	8	17	900	46,0	71	81	0,580		
CE02- 40	40	53	75	70	30	13,0	50,0	56,0	M 6 x 18	8	17	900	46,0	67	76	0,626		
CE02- 42	42	55	78	73	40	17,0	65,0	73,0	M 8 x 22	8	41	1800	84,0	89	101	0,880		
CE02- 45	45	59	85	79	40	17,0	65,0	73,0	M 8 x 22	8	41	1900	84,0	84	94	1,028		
CE02- 48	48	62	87	82	45	17,0	70,0	78,0	M 8 x 22	8	41	2000	84,0	72	79	0,980		
CE02- 50	50	65	92	85	45	17,0	70,0	78,0	M 8 x 22	10	41	2600	105,0	87	95	1,270		
CE02- 55	55	71	98	92	50	17,0	75,0	83,0	M 8 x 22	10	41	2900	105,0	73	78	1,480		
CE02- 60	60	77	104	98	50	17,0	75,0	83,0	M 8 x 22	10	41	3100	105,0	67	72	1,658		
CE02- 65	65	84	111	105	50	17,0	75,0	83,0	M 8 x 22	10	41	3400	105,0	62	66	1,922		
CE02- 70	70	90	119	114	60	20,0	91,0	101,0	M10 x 25	10	83	5800	170,0	91	82	2,936		
CE02- 75	75	95	126	120	60	20,0	91,0	101,0	M10 x 25	10	83	6200	170,0	70	77	2,290		
CE02- 80	80	100	131	125	65	20,0	96,0	106,0	M10 x 25	12	83	7800	200,0	74	81	3,342		
CE02- 85	85	106	137	131	65	20,0	96,0	106,0	M10 x 25	12	83	8500	200,0	70	77	3,622		
CE02- 90	90	112	143	137	65	20,0	96,0	106,0	M10 x 25	15	83	11200	250,0	83	91	3,956		
CE02- 95*	95	120	153	146	65	20,0	96,0	106,0	M10 x 25	15	83	11800	250,0	78	85	4,460		
CE02-100*	100	125	162	155	65	24,0	102,0	114,0	M12 x 30	12	145	14600	300,0	82	95	6,000		



Type CE03

Bezeichnung Part no.	Abmessung Dimension							Bei Anzugsmoment M_s übertragbar With tightening torque M_s applied		Flächen- pressung Pressure		Ges. Axialkraft der Spann- schrauben Total axial force on the tension screws	Gewicht Weight
	d	D	L	Z				Drehmoment Torque	Axialkraft Axial force	Welle Shaft	Nabe Hub		
				1	2	3	4						
				(mm)	(mm)	(mm)	(mm)						
CE03- 6*	6	9	4,5	3	3	3	4	2	0,8	96	65	4	0,001
CE03- 8*	8	11	4,5	3	3	3	4	5	1,0	108	80	6	0,001
CE03- 10*	10	13	4,5	3	3	3	4	10	2,0	112	100	16	0,002
CE03- 12*	12	15	4,5	3	3	3	4	11	2,0	111	90	16	0,002
CE03- 14	14	18	6,3	3	4	4	5	22	3,0	112	90	26	0,004
CE03- 15	15	19	6,3	3	4	4	5	25	3,0	112	90	27	0,004
CE03- 16	16	20	6,3	3	4	4	5	26	3,0	112	90	27	0,005
CE03- 17	17	21	6,3	3	4	4	5	30	3,0	112	90	27	0,006
CE03- 18	18	22	6,3	3	4	4	5	33	3,0	112	90	33	0,006
CE03- 19	19	24	6,3	3	4	4	5	40	4,0	112	90	33	0,006
CE03- 20	20	25	6,3	3	4	4	5	44	4,0	112	90	33	0,008
CE03- 22	22	26	6,3	3	4	4	5	50	4,0	100	90	34	0,010
CE03- 24	24	28	6,3	3	4	4	5	68	6,0	114	100	34	0,006
CE03- 25	25	30	6,3	3	4	4	5	75	6,0	120	100	37	0,010
CE03- 28	28	32	6,3	3	4	4	5	90	6,0	111	100	40	0,008
CE03- 30	30	35	6,3	3	4	4	5	100	7,0	111	100	40	0,012
CE03- 32	32	36	6,3	3	4	4	5	120	7,0	111	100	40	0,010
CE03- 35	35	40	7,0	3	4	4	5	160	9,0	111	100	50	0,015
CE03- 38	38	44	7,0	4	5	5	6	190	10,0	111	100	60	0,020
CE03- 40	40	45	8,0	4	5	5	6	230	11,0	111	100	70	0,020
CE03- 42	42	48	8,0	4	5	5	6	260	12,0	111	100	70	0,025
CE03- 45	45	52	10,0	4	5	5	6	390	17,0	111	100	110	0,039
CE03- 48	48	55	10,0	4	5	5	6	430	18,0	111	100	110	0,042
CE03- 50	50	57	10,0	4	5	5	6	470	19,0	111	100	110	0,044
CE03- 55	55	62	10,0	4	5	5	6	580	21,0	111	100	120	0,048
CE03- 60	60	68	12,0	4	5	6	7	840	28,0	111	100	160	0,072
CE03- 65	65	73	12,0	4	5	6	7	1000	30,0	111	100	160	0,078
CE03- 70	70	79	14,0	4	5	6	7	1300	38,0	111	100	200	0,112
CE03- 75	75	84	14,0	4	5	6	7	1500	41,0	111	100	220	0,120
CE03- 80	80	91	17,0	5	6	7	8	2100	54,0	111	100	300	0,190
CE03- 85*	85	96	17,0	5	6	7	8	2300	56,0	111	100	310	0,200
CE03- 90	90	101	17,0	5	6	7	8	2700	61,0	111	100	320	0,212
CE03- 95*	95	106	17,0	5	6	7	8	3500	73,0	111	100	380	0,230
CE03-100	100	114	21,0	5	6	8	9	4200	84,0	111	100	440	0,376
CE03-110*	110	124	21,0	5	6	8	9	4300	86,0	111	90	450	0,410
CE03-120*	120	134	21,0	5	6	8	9	5100	88,0	111	90	460	0,450
CE03-130*	130	148	28,0	6	7	9	11	8100	125,0	111	90	650	0,828
CE03-140*	140	158	28,0	6	7	9	11	9400	135,0	111	90	690	0,898
CE03-150*	150	168	28,0	6	7	9	11	11000	145,0	111	90	720	0,973



Type CE04

Bezeichnung Part no.	Abmessung Dimension				Schrauben Screws			Bei Anzugsmoment M_s übertragbar With tightening torque M_s applied		Flächen- pressung Pressure		Gewicht Weight
	d	D	B	L	Bezeichnung Part no.	Anzahl No.	Anzugs- moment Tightening torque M_s	Drehmoment Torque	Axialkraft Axial force	Welle Shaft	Nabe Hub	
								M	F	P_W	P_N	
								(N _m)	(K _N)	(N/mm ²)	(N/mm ²)	
(mm)	(mm)	(mm)	(mm)		Stück Each	(N _m)	(N _m)	(K _N)	(N/mm ²)	(N/mm ²)	(kg)	
CE04- 20	20	47	42	48	M 6 x 25	6	17	530	52	190	110	0,384
CE04- 22	22	47	42	48	M 6 x 25	6	17	580	52	170	110	0,366
CE04- 24	24	50	42	48	M 6 x 25	6	17	630	52	160	100	0,410
CE04- 25	25	50	42	48	M 6 x 25	6	17	660	52	150	100	0,402
CE04- 28	28	55	42	48	M 6 x 25	6	17	740	52	130	100	0,482
CE04- 30	30	55	42	48	M 6 x 25	6	17	790	52	130	100	0,458
CE04- 32	32	60	42	48	M 6 x 25	8	17	1180	70	160	120	0,520
CE04- 35	35	60	42	48	M 6 x 25	8	17	1230	70	140	120	0,510
CE04- 38	38	65	42	48	M 6 x 25	8	17	1300	70	130	110	0,600
CE04- 40	40	65	42	48	M 6 x 25	8	17	1400	70	125	110	0,568
CE04- 42	42	75	50	58	M 8 x 30	6	41	2000	100	130	120	1,020
CE04- 45	45	75	50	58	M 8 x 30	6	41	2200	100	125	120	0,934
CE04- 48	48	80	50	58	M 8 x 30	8	41	3200	130	155	150	1,050
CE04- 50	50	80	50	58	M 8 x 30	8	41	3300	130	150	150	1,008
CE04- 55	55	85	50	58	M 8 x 30	8	41	3600	130	135	140	1,124
CE04- 60	60	90	50	58	M 8 x 30	8	41	3900	130	125	130	1,210
CE04- 65	65	95	50	58	M 8 x 30	8	41	4200	130	115	120	1,234
CE04- 70	70	110	60	70	M10 x 30	8	83	7500	210	150	130	2,306
CE04- 75*	75	115	60	70	M10 x 30	8	83	8000	210	140	130	2,466
CE04- 80	80	120	60	70	M10 x 30	8	83	8500	210	130	120	2,588
CE04- 85*	85	125	60	70	M10 x 30	10	83	11400	270	155	150	2,700
CE04- 90	90	130	60	70	M10 x 30	10	83	12000	270	145	140	2,832
CE04-100	100	145	68	80	M12 x 35	8	145	15000	300	130	120	3,936
CE04-110*	110	155	68	80	M12 x 35	8	145	16500	300	120	110	4,300
CE04-120*	120	165	68	80	M12 x 35	10	145	22500	370	135	130	4,600
CE04-130*	130	180	68	80	M12 x 35	12	145	29300	450	150	140	5,500
CE04-140*	140	190	76	90	M14 x 40	10	210	32200	460	130	125	6,700
CE04-150*	150	200	76	90	M14 x 40	12	210	41400	550	145	140	7,000
CE04-160*	160	210	76	90	M14 x 40	12	210	44100	550	135	130	7,500
CE04-170*	170	225	76	90	M14 x 40	14	210	54700	640	150	150	8,700
CE04-180*	180	235	76	90	M14 x 40	14	210	57900	640	140	140	9,200



Type CE05

Bezeichnung Part no.	Abmessung Dimension				Schrauben Screws			Bei Anzugsmoment M_s übertragbar With tightening torque M_s applied		Flächen- pressung Pressure		Gewicht Weight
	d	D	B	L	Bezeichnung Part no.	Anzahl No.	Anzugs- moment Tightening torque M_s	Drehmoment Torque	Axialkraft Axial force	Welle Shaft	Nabe Hub	
								M	F	P_W	P_N	
								(N _m)	(K _N)	(N/mm ²)	(N/mm ²)	
(mm)	(mm)	(mm)	(mm)	Stück Each	(N _m)	(N _m)	(K _N)	(N/mm ²)	(N/mm ²)	(kg)		
CE05- 20	20	47	28	34	M 6 x 20	6	14	410	41	218	137	0,260
CE05- 22	22	47	28	34	M 6 x 20	6	14	450	41	198	137	0,250
CE05- 24*	24	50	28	34	M 6 x 20	6	14	490	41	182	128	0,276
CE05- 25	25	50	28	34	M 6 x 20	6	14	510	41	175	128	0,268
CE05- 28*	28	55	28	34	M 6 x 20	6	14	570	41	156	117	0,322
CE05- 30	30	55	28	34	M 6 x 20	6	14	610	41	145	117	0,304
CE05- 32*	32	60	28	34	M 6 x 20	8	14	880	54	182	143	0,370
CE05- 35	35	60	28	34	M 6 x 20	8	14	960	54	166	143	0,344
CE05- 38*	38	65	28	34	M 6 x 20	8	14	1040	54	153	132	0,408
CE05- 40	40	65	28	34	M 6 x 20	8	14	1090	54	145	132	0,378
CE05- 42*	42	75	33	41	M 8 x 25	8	35	2200	105	201	186	0,630
CE05- 45	45	75	33	41	M 8 x 25	8	35	2360	105	207	186	0,630
CE05- 48*	48	80	33	41	M 8 x 25	8	35	2520	105	194	174	0,680
CE05- 50	50	80	33	41	M 8 x 25	8	35	2620	105	186	174	0,686
CE05- 55*	55	85	33	41	M 8 x 25	8	35	2890	105	169	164	0,720
CE05- 60	60	90	33	41	M 8 x 25	8	35	3150	105	155	155	0,794
CE05- 65*	65	95	33	41	M 8 x 25	8	35	3410	105	143	174	0,842
CE05- 70*	70	110	40	50	M10 x 30	8	70	5990	170	180	172	1,534
CE05- 75*	75	115	40	50	M10 x 30	8	70	6420	170	168	165	1,634
CE05- 80*	80	120	40	50	M10 x 30	8	70	6850	170	158	158	1,722
CE05- 85*	95	125	40	50	M10 x 30	10	70	9090	210	186	189	1,834
CE05- 90*	90	130	40	50	M10 x 30	10	70	9630	210	175	182	1,900
CE05-100*	100	145	44	56	M12 x 30	8	115	11900	240	158	168	2,618
CE05-110*	110	155	44	56	M12 x 30	8	115	13090	240	144	157	2,788
CE05-120*	120	165	44	56	M12 x 30	9	115	16060	270	148	166	3,600
CE05-130*	130	180	52	64	M12 x 30	12	115	23200	360	152	155	4,410
CE05-140*	140	190	54	68	M14 x 40	9	185	25500	360	138	150	4,920
CE05-150*	150	200	54	68	M14 x 40	10	185	30300	400	143	158	5,200
CE05-160*	160	210	54	68	M14 x 40	12	185	38800	490	161	181	5,600
CE05-180*	180	235	64	78	M14 x 40	12	185	43700	490	119	125	8,500
CE05-200*	200	260	64	78	M14 x 40	15	185	60700	610	134	141	9,600

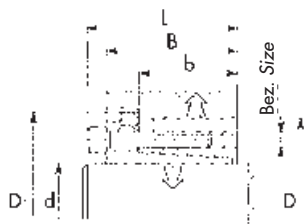

Type CE06

Bezeichnung Part no.	Abmessung Dimension						Schrauben Screws			Bei Anzugsmoment M _s übertragbar With tightening torque M _s applied		Flächen- pressung Pressure		Gewicht Weight
	d	D	D ₁	b	B	L	Bezeichnung Part no.	Anzahl No.	Anzugs- moment Tightening torque M _s	Drehmoment	Axialkraft	Welle	Nabe	
										Torque	Axial force	Shaft	Hub	
										M	F	P _W	P _N	
(mm)	(mm)	(mm)	(mm)	(mm)	(mm)		Stück Each	(N _m)	(N _m)	(K _N)	(N/mm ²)	(N/mm ²)	(kg)	
CE06- 20	20	47	53	31,0	42	48	M 6 x 25	6	17	320	33	116	70	0,416
CE06- 22	22	47	53	31,0	42	48	M 6 x 25	6	17	360	33	105	70	0,398
CE06- 24	24	50	56	31,0	42	48	M 6 x 25	6	17	390	33	97	70	0,442
CE06- 25	25	50	56	31,0	42	48	M 6 x 25	6	17	400	33	93	70	0,434
CE06- 28	28	55	61	31,0	42	48	M 6 x 25	6	17	450	33	83	60	0,516
CE06- 30	30	55	61	31,0	42	48	M 6 x 25	6	17	490	33	77	60	0,492
CE06- 32	32	60	66	31,0	42	48	M 6 x 25	8	17	690	43	97	70	0,560
CE06- 35	35	60	66	31,0	42	48	M 6 x 25	8	17	750	43	88	70	0,548
CE06- 38	38	65	71	31,0	42	48	M 6 x 25	8	17	820	43	81	70	0,650
CE06- 40	40	65	71	31,0	42	48	M 6 x 25	8	17	860	43	77	70	0,608
CE06- 42	42	75	81	36,0	50	58	M 8 x 30	6	41	1250	60	82	70	1,090
CE06- 45	45	75	81	36,0	50	58	M 8 x 30	6	41	1340	60	77	70	1,004
CE06- 48	48	80	86	36,0	50	58	M 8 x 30	8	41	1910	80	96	90	1,100
CE06- 50	50	80	86	36,0	50	58	M 8 x 30	8	41	1990	80	92	90	1,074
CE06- 55	55	85	91	36,0	50	58	M 8 x 30	8	41	2200	80	84	90	1,204
CE06- 60	60	90	96	36,0	50	58	M 8 x 30	8	41	2400	80	77	80	1,292
CE06- 65	65	95	101	36,0	50	58	M 8 x 30	8	41	2600	80	71	70	1,308
CE06- 70	70	110	119	46,0	60	70	M10 x 30	8	83	4600	130	92	80	2,440
CE06- 75*	75	115	124	46,0	60	70	M10 x 30	8	83	4930	130	86	80	2,596
CE06- 80	80	120	129	46,0	60	70	M10 x 30	8	83	5200	130	81	70	2,730
CE06- 85*	85	125	134	46,0	60	70	M10 x 30	10	83	7000	165	95	90	2,800
CE06- 90	90	130	139	46,0	60	70	M10 x 30	10	83	7400	165	90	80	2,986
CE06-100	100	145	155	52,0	68	80	M12 x 35	8	145	9700	190	84	80	4,136
CE06-110*	110	155	165	52,0	68	80	M12 x 35	8	145	10680	190	77	70	4,500
CE06-120*	120	165	175	52,0	68	80	M12 x 35	10	145	14500	240	88	90	4,800
CE06-130*	130	180	188	52,0	68	80	M12 x 35	12	145	18900	290	97	100	5,800
CE06-140*	140	190	199	58,5	76	90	M14 x 40	10	230	22800	325	91	90	7,000
CE06-150*	150	200	209	58,5	76	90	M14 x 40	12	230	29300	390	102	100	7,300
CE06-160*	160	210	219	58,5	76	90	M14 x 40	12	230	31300	390	95	100	7,800
CE06-170*	170	225	234	58,5	76	90	M14 x 40	14	230	38800	460	105	110	9,600
CE06-180*	180	235	244	58,5	76	90	M14 x 40	14	230	41000	460	99	100	9,000

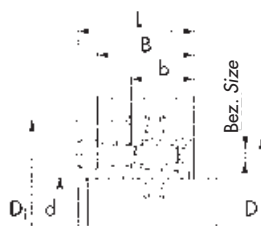

Type CE07

Bezeichnung Part no.	Abmessung Dimension						Schrauben Screws			Bei Anzugsmoment M _s übertragbar With tightening torque M _s applied		Flächen- pressung Pressure		Gewicht Weight
	d	D	D ₁	b	B	L	Bezeichnung Part no.	Anzahl No.	Anzugs- moment Tightening torque M _s	Drehmoment	Axialkraft	Welle	Nabe	
										Torque	Axial force	Shaft	Hub	
										M	F	P _W	P _N	
(mm)	(mm)	(mm)	(mm)	(mm)	(mm)		Stück Each	(N _m)	(N _m)	(K _N)	(N/mm ²)	(N/mm ²)	(kg)	
CE07- 20	20	47	56	22	28	34	M 6 x 20	6	17	320	32	171	100	0,280
CE07- 22	22	47	56	22	28	34	M 6 x 20	6	17	350	32	156	100	0,270
CE07- 24	24	50	59	22	28	34	M 6 x 20	6	17	390	32	143	100	0,310
CE07- 25	25	50	59	22	28	34	M 6 x 20	6	17	400	32	137	100	0,304
CE07- 28	28	55	64	22	28	34	M 6 x 20	6	17	450	32	122	90	0,362
CE07- 30	30	55	64	22	28	34	M 6 x 20	6	17	490	32	114	90	0,346
CE07- 32	32	60	69	22	28	34	M 6 x 20	8	17	700	43	143	110	0,420
CE07- 35	35	60	69	22	28	34	M 6 x 20	8	17	760	43	131	110	0,390
CE07- 38	38	65	74	22	28	34	M 6 x 20	8	17	820	43	120	100	0,454
CE07- 40	40	65	74	22	28	34	M 6 x 20	8	17	870	43	114	100	0,446
CE07- 42	42	75	84	25	33	41	M 8 x 25	6	41	1700	80	168	140	0,440
CE07- 45	45	75	84	25	33	41	M 8 x 25	6	41	1800	80	157	140	0,696
CE07- 48	48	80	89	25	33	41	M 8 x 25	8	41	1900	80	147	130	0,800
CE07- 50	50	80	89	25	33	41	M 8 x 25	8	41	2000	80	141	130	0,756
CE07- 55	55	85	91	25	33	41	M 8 x 25	8	41	2200	80	128	120	0,850
CE07- 60	60	90	99	25	33	41	M 8 x 25	8	41	2400	80	117	120	0,900
CE07- 65	65	95	104	25	33	41	M 8 x 25	8	41	2600	80	108	110	0,934
CE07- 70	70	110	119	30	40	50	M10 x 30	8	83	4600	130	138	130	1,670
CE07- 75	75	115	124	30	40	50	M10 x 30	8	83	5000	130	129	130	1,760
CE07- 80	80	120	129	30	40	50	M10 x 30	8	83	5300	130	121	120	1,868
CE07- 85	85	125	134	30	40	50	M10 x 30	10	83	7000	160	142	150	1,966
CE07- 90	90	130	139	30	40	50	M10 x 30	10	83	7400	160	135	140	2,046
CE07-100	100	145	154	32	44	56	M12 x 30	8	145	9700	200	129	140	2,830
CE07-110	110	155	164	32	44	56	M12 x 30	8	145	10700	200	117	130	3,100
CE07-120	120	165	174	32	44	56	M12 x 30	9	145	13100	220	121	140	3,284
CE07-130	130	180	189	40	52	64	M12 x 30	12	145	19000	290	124	130	4,600
CE07-140*	140	190	199	40	54	68	M14 x 40	9	230	20500	300	111	120	4,980
CE07-150*	150	200	209	40	54	68	M14 x 40	10	230	24500	330	115	130	5,200
CE07-160*	160	210	219	40	54	68	M14 x 40	12	230	31300	390	130	150	5,600
CE07-180*	180	235	244	50	64	78	M14 x 40	12	230	35000	390	96	100	8,500
CE07-200*	200	260	269	50	64	78	M14 x 40	15	230	49000	500	108	110	9,600

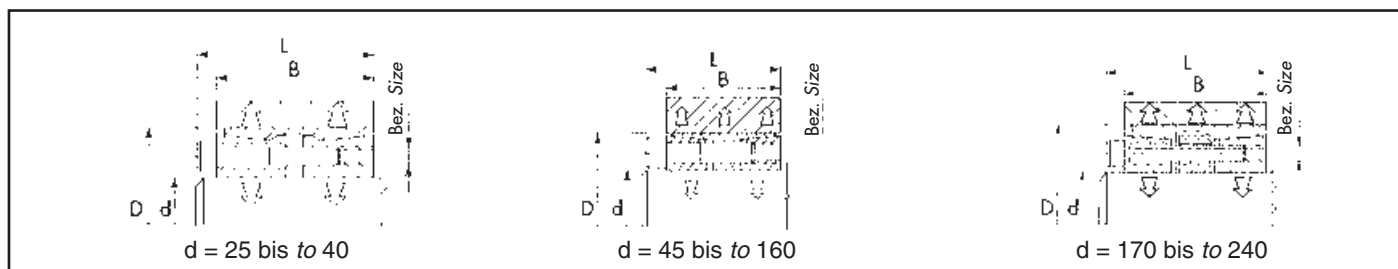

Type CE08												
Bezeichnung Part no.	Abmessung Dimension				Schrauben Screws			Bei Anzugsmoment M_s übertragbar With tightening torque M_s applied		Flächen- pression Pressure		Gewicht Weight
	d	D	B	L	Bezeichnung Part no.	Anzahl No.	Anzugs- moment Tightening torque M_s	Drehmoment Torque	Axialkraft Axial force	Welle Shaft	Nabe Hub	
								M	F	P_W	P_N	
								(N _m)	(K _N)	(N/mm ²)	(N/mm ²)	
(mm)	(mm)	(mm)	(mm)		Stück Each	(N _m)	(N _m)	(K _N)	(N/mm ²)	(N/mm ²)	(kg)	
CE08- 25*	25	50	45	51	M 6 x 35	6	17	700	55	157	80	0,415
CE08- 30*	30	55	45	51	M 6 x 35	8	17	1200	70	175	90	0,464
CE08- 35*	35	60	45	51	M 6 x 35	8	17	1400	70	150	90	0,526
CE08- 40*	40	65	45	51	M 6 x 35	10	17	2000	90	164	100	0,550
CE08- 45	45	75	45	53	M 8 x 35	8	41	3200	140	216	130	0,768
CE08- 50	50	80	64	72	M 8 x 55	8	41	3600	140	165	80	1,326
CE08- 55*	55	85	64	72	M 8 x 55	8	41	4000	140	150	80	1,430
CE08- 60	60	90	64	72	M 8 x 55	10	41	5400	170	171	90	1,524
CE08- 65*	65	95	64	72	M 8 x 55	10	41	5800	170	158	90	2,000
CE08- 70	70	110	78	88	M10 x 60	10	83	10300	280	199	100	2,932
CE08- 75*	75	115	78	88	M10 x 60	10	83	11000	280	186	100	3,100
CE08- 80	80	120	78	88	M10 x 60	12	83	14000	340	209	110	3,300
CE08- 85*	85	125	78	88	M10 x 60	12	83	15000	340	197	110	3,400
CE08- 90	90	130	78	88	M10 x 60	12	83	16000	340	186	100	3,600
CE08- 95*	95	135	78	88	M10 x 60	12	83	17000	340	176	100	4,000
CE08-100	100	145	100	112	M12 x 80	12	145	26000	500	198	100	6,000
CE08-110*	110	155	100	112	M12 x 80	12	145	29000	500	180	100	6,000
CE08-120*	120	165	100	112	M12 x 80	14	145	36400	600	192	110	6,000
CE08-130*	130	180	116	130	M14 x 90	12	230	45400	700	174	100	10,100
CE08-140*	140	190	116	130	M14 x 90	14	230	57000	800	189	110	10,500
CE08-150*	150	200	116	130	M14 x 90	16	230	70000	900	201	120	11,000
CE08-160*	160	210	116	130	M14 x 90	16	230	75000	900	189	110	12,000
CE08-170*	170	225	146	162	M16 x 110	14	355	95000	1100	168	100	17,000
CE08-180*	180	235	146	162	M16 x 110	15	355	115000	1200	182	110	18,400
CE08-190*	190	250	146	162	M16 x 110	16	355	121500	1200	172	100	21,400
CE08-200*	200	260	146	162	M16 x 110	16	355	128000	1200	163	100	21,800

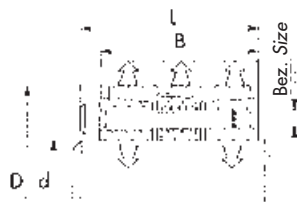

Type CE09

Bezeichnung Part no.	Abmessung Dimension				Schrauben Screws			Bei Anzugsmoment M_s übertragbar With tightening torque M_s applied		Flächen- pressung Pressure		Gewicht Weight
	d	D	B	L	Bezeichnung Part no.	Anzahl No.	Anzugs- moment Tightening torque M_s	Drehmoment Torque	Axialkraft Axial force	Welle Shaft	Nabe Hub	
								M	F	P_W	P_N	
(mm)	(mm)	(mm)	(mm)		Stück Each	(N _m)	(N _m)	(K _N)	(N/mm ²)	(N/ mm ²)	(kg)	
CE09- 45*	45	75	64	72	M 8 x 55	8	41	3200	120	210	125	1,000
CE09- 50*	50	80	78	86	M 8 x 65	8	41	3550	120	140	65	1,500
CE09- 60	60	90	78	86	M 8 x 65	10	41	5330	150	146	75	2,000
CE09- 70	70	110	102	112	M10 x 90	10	83	10260	250	147	75	4,000
CE09- 80*	80	120	102	112	M10 x 90	12	83	14000	300	154	85	5,000
CE09- 90*	90	130	102	112	M10 x 90	12	83	15800	300	137	75	6,000
CE09-100*	100	145	122	134	M12 x 110	12	145	26000	450	149	85	7,000



Type CE10

Bezeichnung Part no.	Abmessung Dimension					Schrauben Screws			Bei Anzugsmoment M_s übertragbar With tightening torque M_s applied		Flächen- pressung Pressure		Gewicht Weight
									Drehmoment Torque	Axialkraft Axial force	Welle Shaft	Nabe Hub	
	d	D	D ₁	B	L	Bezeichnung Part no.	Anzahl No.	Anzugs- moment Tightening torque M_s	M	F	P _W	P _N	
	(mm)	(mm)	(mm)	(mm)	(mm)		Stück Each	(N _m)	(N _m)	(K _N)	(N/mm ²)	(N/mm ²)	
CE10-14	14	25	32	6,5	16,5	M20 x 1,5	1	65	37	6	171	73	0,052
CE10-15	15	25	32	6,5	16,5	M20 x 1,5	1	65	40	6	159	73	0,050
CE10-16	16	25	32	6,5	16,5	M20 x 1,5	1	65	42	6	149	73	0,048
CE10-18	18	30	38	7,0	17,0	M25 x 1,5	1	85	65	8	168	80	0,080
CE10-19	19	30	38	7,0	17,0	M25 x 1,5	1	95	60	7	136	70	0,078
CE10-20	20	30	38	7,0	17,0	M25 x 1,5	1	110	70	8	149	80	0,074
CE10-24	24	35	45	7,0	17,0	M30 x 1,5	1	155	100	10	147	80	0,100
CE10-25	25	35	45	7,0	17,0	M30 x 1,5	1	160	110	10	146	90	0,092
CE10-28	28	40	52	8,0	20,0	M35 x 1,5	1	200	140	11	126	70	0,140
CE10-30	30	40	52	8,0	20,0	M35 x 1,5	1	240	170	14	138	80	0,130
CE10-32	32	45	58	9,0	22,0	M40 x 1,5	1	320	210	15	135	80	0,170
CE10-35	35	45	58	9,0	22,0	M40 x 1,5	1	320	230	15	123	80	0,168
CE10-40	40	50	64	9,0	23,0	M45 x 1,5	1	440	330	19	132	90	0,216
CE10-45	45	55	70	10,0	25,5	M50 x 1,5	1	550	440	23	127	90	0,266
CE10-50*	50	60	75	10,0	25,5	M55 x 1,5	1	660	530	25	125	90	0,278
CE10-60*	60	70	85	12,0	29,5	M65 x 1,5	1	900	830	32	112	80	0,390

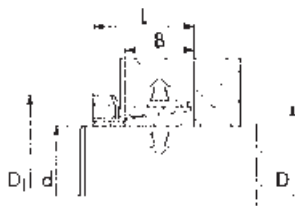

Type CE11

Bezeichnung Part no.	Abmessung Dimension					Schrauben Screws			Bei Anzugsmoment M_s übertragbar With tightening torque M_s applied		Flächen- pressung Pressure		Gewicht Weight
	d	D	D ₁	B	L	Bezeichnung Part no.	Anzahl No.	Anzugs- moment Tightening torque M_s	Drehmoment Torque	Axialkraft Axial force	Welle Shaft	Nabe Hub	
									M	F	P _W	P _N	
									(N _m)	(K _N)	(N/mm ²)	(N/mm ²)	
(mm)	(mm)	(mm)	(mm)	(mm)	Stück Each	(N _m)	(N _m)	(K _N)	(N/mm ²)	(N/mm ²)	(kg)		
CE11-14	14	25	32	17	29	M20 x 1,5	1	90	90	15	145	80	0,080
CE11-15	15	25	32	17	29	M20 x 1,5	1	90	100	15	136	80	0,074
CE11-16	16	25	32	17	29	M20 x 1,5	1	70	80	12	99	60	0,072
CE11-18	18	30	38	18	31	M25 x 1,5	1	190	200	25	179	110	0,120
CE11-19	19	30	38	18	31	M25 x 1,5	1	150	170	20	134	90	0,114
CE11-20	20	30	38	18	31	M25 x 1,5	1	110	130	15	93	60	0,104
CE11-24	24	35	45	22	35	M30 x 1,5	1	230	270	26	112	80	0,162
CE11-25	25	35	45	22	35	M30 x 1,5	1	170	200	19	80	60	0,150
CE11-28	28	40	52	22	35	M35 x 1,5	1	390	460	38	141	110	0,214
CE11-30	30	40	52	22	35	M35 x 1,5	1	240	300	24	63	70	0,192
CE11-32	32	45	58	27	42	M40 x 1,5	1	320	420	31	80	70	0,280
CE11-35	35	45	58	28	42	M40 x 1,5	1	320	460	31	70	60	0,270
CE11-40	40	50	64	28	44	M45 x 1,5	1	440	640	37	75	70	0,330
CE11-45	45	55	70	28	45	M50 x 1,5	1	550	760	40	71	60	0,386
CE11-50	50	60	75	28	46	M50 x 1,5	1	660	930	44	70	60	0,408
CE11-60	60	70	85	28	52	M65 x 1,5	1	1050	1500	59	79	70	0,550

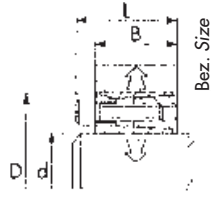

Type CE12

Bezeichnung Part no.	Abmessung Dimension				Schrauben Screws			Bei Anzugsmoment M_s übertragbar With tightening torque M_s applied		Flächen- pressung Pressure		Gewicht Weight
	d	D	B	L	Bezeichnung Part no.	Anzahl No.	Anzugs- moment Tightening torque M_s	Drehmoment	Axialkraft	Welle	Nabe	
								Torque	Axial force	Shaft	Hub	
								M	F	P_W	P_N	
(mm)	(mm)	(mm)	(mm)		Stück Each	(N _m)	(N _m)	(K _N)	(N/mm ²)	(N/ mm ²)	(kg)	
CE12-16*	16	32	17,0	21,0	M4 x 14	4	5	80	13	134	68	0,070
CE12-18*	18	40	18,0	24,0	M6 x 15	4	17	180	24	119	100	0,122
CE12-19*	19	41	18,0	24,0	M6 x 15	4	17	190	24	215	100	0,126
CE12-20*	20	42	18,0	24,0	M6 x 15	4	17	200	24	204	100	0,130
CE12-22*	22	44	18,0	24,0	M6 x 15	4	17	220	24	186	90	0,138
CE12-24*	24	46	18,0	24,0	M6 x 15	6	17	360	36	170	130	0,150
CE12-25*	25	47	18,0	24,0	M6 x 15	6	17	380	36	245	130	0,160
CE12-28*	28	50	18,0	24,0	M6 x 15	6	17	420	36	219	120	0,165
CE12-30*	30	52	18,0	24,0	M6 x 15	6	17	450	36	204	120	0,174
CE12-32*	32	54	18,0	24,0	M6 x 15	6	17	480	36	191	110	0,184
CE12-35*	35	57	21,5	27,5	M6 x 15	6	17	520	36	139	90	0,242
CE12-40*	40	62	21,5	27,5	M6 x 15	8	17	600	36	122	80	0,272
CE12-45*	45	73	28,0	36,0	M8 x 22	8	41	1700	90	84	130	0,514
CE12-50*	50	78	28,0	36,0	M8 x 22	8	41	1840	90	187	120	0,570
CE12-60*	60	88	28,0	36,0	M8 x 22	8	41	2200	90	156	100	0,644

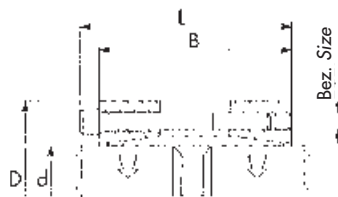

Type CE13

Bezeichnung Part no.	Abmessung Dimension				Schrauben Screws			Bei Anzugsmoment M_s übertragbar With tightening torque M_s applied		Flächen- pressung Pressure		Gewicht Weight
	d	D	B	L	Bezeichnung Part no.	Anzahl No.	Anzugs- moment Tightening torque M_s	Drehmoment Torque	Axialkraft Axial force	Welle Shaft	Nabe Hub	
								M	F	P_W	P_N	
								(N _m)	(K _N)	(N/mm ²)	(N/mm ²)	
(mm)	(mm)	(mm)	(mm)		Stück Each	(N _m)	(N _m)	(K _N)	(N/mm ²)	(N/mm ²)	(kg)	
CE13-15*	15	45	50	56	M 6 x 45	4	17	150	18	81		0,378
CE13-16*	16	45	50	56	M 6 x 45	4	17	160	18	76		0,370
CE13-18*	18	50	50	56	M 6 x 45	4	17	180	18	68		0,450
CE13-19*	19	50	50	56	M 6 x 45	4	17	190	18	64		0,444
CE13-20*	20	50	50	56	M 6 x 45	4	17	200	18	61		0,436
CE13-24*	24	55	60	66	M 6 x 55	6	17	360	27	63		0,632
CE13-25*	25	55	60	66	M 6 x 55	6	17	380	27	60		0,616
CE13-28*	28	60	60	66	M 6 x 55	6	17	370	24	46		0,752
CE13-30*	30	60	60	66	M 6 x 55	6	17	400	24	43		0,712
CE13-35*	35	75	75	83	M 8 x 70	4	41	640	32	41		1,328
CE13-40*	40	75	75	83	M 8 x 70	4	41	730	32	36		1,188
CE13-45*	45	85	85	93	M 8 x 80	6	41	1200	48	41		1,716
CE13-50*	50	90	85	93	M 8 x 80	6	41	1340	48	37		1,884
CE13-60*	60	100	85	93	M 8 x 80	8	41	2200	64	41		2,174
CE13-70*	70	115	100	110	M10 x 80	6	83	3200	80	38		4,000

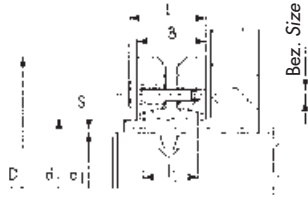

Type CE14

Bezeichnung Part no.	Abmessung Dimension							Schrauben Screws			Bei Anzugsmoment M _s übertragbar With tightening torque M _s applied		Flächen- pressung Pressure		Gewicht Weight
	d	d ₁	D	B	L	l ₁	S	Bez. Size	Anzahl No.	Anzugs- moment Tightening torque M _s	Drehmoment Torque	Axialkraft Axial force	Welle Shaft	Nabe Hub	
											M	F	P _w	P _N	
											(N _m)	(K _N)	(N/ mm ²)	(N/ mm ²)	
(mm)	(mm)	(mm)	(mm)	(mm)	(mm)	(mm)		Stück Each	(N _m)	(K _N)	(N/ mm ²)	(N/ mm ²)	(kg)		
CE14- 24*	24	19	50	19	23,0	14	0,017	M5	6	4	180	26	140	280	0,184
		20									27	170	280		
		21									29	200	280		
CE14- 30*	30	24	60	21	25,0	16	0,017	M5	6	4	310	26	200	300	0,288
		25									27	205	300		
		26									28	220	300		
CE14- 36*	36	28	72	23	27,0	18	0,017	M6	6	12	460	50	235	360	0,468
		30									54	240	360		
		31									58	260	360		
CE14- 44*	44	32	80	25	29,0	20	0,032	M6	8	12	630	65	225	350	0,590
		35									74	240	350		
		36									77	255	350		
CE14- 50*	50	38	90	27	31,0	22	0,032	M6	8	12	940	79	180	285	0,794
		40									85	200	285		
		42									90	220	285		
CE14- 55*	55	42	100	30	34,0	23	0,032	M6	8	12	1200	80	155	250	1,104
		45									90	180	250		
		48									100	200	250		
CE14- 62*	62	48	110	30	34,0	23	0,032	M6	10	12	1800	100	190	270	1,312
		50									110	195	270		
		52									120	210	270		
CE14- 68*	68	50	115	30	34,0	23	0,038	M6	10	12	2000	100	140	250	1,304
		55									110	175	250		
		60									120	210	250		
CE14- 75*	75	55	138	33	38,0	25	0,048	M8	8	30	2500	120	190	300	1,700
		60									140	220	300		
		65									150	250	300		
CE14- 80*	80	60	145	32	38,0	25	0,048	M8	8	30	3200	120	185	280	2,540
		65									140	210	280		
		70									160	240	280		
CE14- 90*	90	65	155	39	45,0	30	0,048	M8	10	30	4700	170	180	260	3,300
		70									190	200	260		
		75									210	220	260		
CE14-100*	100	70	170	44	49,5	34	0,048	M8	12	30	6900	180	165	250	4,410
		75									220	185	250		
		80									240	190	250		
CE14-110*	110	75	185	50	57,0	39	0,048	M10	10	59	7200	230	160	260	5,900
		80									250	170	260		
		85									260	185	260		
CE14-115*	115	80	188	50	57,0	39	0,048	M10	10	59	8500	210	150	245	9,000
		85									240	170	245		
		90									270	180	245		
CE14-125*	125	85	215	54	61,0	42	0,056	M10	12	59	11000	300	160	260	8,600
		90									320	180	260		
		95									350	190	260		
CE14-130*	130	90	215	52	59,0	42	0,056	M10	12	59	13700	300	160	250	8,700
		95									330	180	250		
		100									360	190	250		

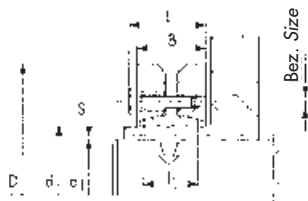

Type CE14

Bezeichnung Part no.	Abmessung Dimension							Schrauben Screws			Bei Anzugsmoment M _s übertragbar With tightening torque M _s applied		Flächen- pressung Pressure		Gewicht Weight
	d	d ₁	D	B	L	l ₁	S	Bez. Size	Anzahl No.	Anzugs- moment Tightening torque M _s	Drehmoment Torque	Axialkraft Axial force	Welle Shaft	Nabe Hub	
											M	F	P _w	P _N	
											(N _m)	(K _N)	(N/ mm ²)	(N/ mm ²)	
(mm)	(mm)	(mm)	(mm)	(mm)	(mm)	(mm)	Stück Each	(N _m)	(N _m)	(K _N)	(N/ mm ²)	(N/ mm ²)	(kg)		
CE14-140*	140	95	230	60	68,0	46	0,056	M12	10	100	15000	360	170	260	10,000
		100									17000	400	185	260	
		105									20000	420	195	260	
CE14-155*	155	105	263	62	70,0	50	0,069	M12	12	100	20000	390	180	255	11,500
		110									23000	420	190	255	
		115									26000	450	200	255	
CE14-165*	165	115	290	68	78,0	56	0,069	M16	8	250	36000	630	195	265	20,600
		120									39000	660	200	265	
		125									44000	700	210	265	
CE14-175*	175	125	300	68	78,0	56	0,079	M16	8	250	40000	650	185	250	21,400
		130									44000	680	190	250	
		135									49000	720	200	250	
CE14-185*	185	135	330	86	96,0	71	0,079	M16	10	250	55000	815	175	230	33,400
		140									60000	875	185	230	
		145									65000	896	190	230	
CE14-195*	195	140	350	86	96,0	71	0,079	M16	12	250	66000	950	210	265	38,000
		150									76000	1000	220	265	
		155									82000	1100	230	265	
CE14-220*	220	160	370	104	114,0	88	0,079	M16	15	250	95000	1200	190	235	54,000
		165									102000	1300	195	235	
		170									110000	1300	200	235	
CE14-240*	240	170	405	109	122,0	92	0,079	M20	12	490	120000	1500	210	260	67,000
		180									140000	1600	220	260	
		190									160000	1700	225	260	
CE14-260*	260	190	430	120	133,0	103	0,090	M20	14	490	165000	1700	205	250	82,000
		200									185000	1900	220	250	
		210									205000	2000	225	250	

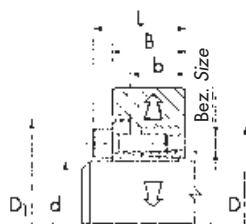

Type CE16

Bezeichnung Part no.	Abmessung Dimension						Schrauben Screws			Bei Anzugsmoment M _s übertragbar With tightening torque M _s applied		Flächen- pressung Pressure		Gewicht Weight (kg)
	d	D	D ₁	b	B	L	Bezeichnung Part no.	Anzahl No. Stück Each	Anzugs- moment Tightening torque M _s (N _m)	Drehmoment Torque	Axialkraft Axial force	Welle Shaft	Nabe Hub	
										M	F	P _W	P _N	
										(N _m)	(K _N)	(N/ mm ²)	(N/ mm ²)	
CE16-14x55*	14	55	62	23	31	39	M8 x 25	4	41	287	41	311	103	0,480
CE16-16x55*	16	55	62	23	31	39	M8 x 25	4	41	329	41	272	103	0,460
CE16-18x55*	18	55	62	23	31	39	M8 x 25	4	41	370	41	242	103	0,450
CE16-19x55*	19	55	62	23	31	39	M8 x 25	4	41	390	41	229	103	0,440
CE16-20x55*	20	55	62	23	31	39	M8 x 25	4	41	410	41	218	103	0,440
CE16-22x55*	22	55	62	23	31	39	M8 x 25	4	41	451	41	198	103	0,420
CE16-24x55*	24	55	62	23	31	39	M8 x 25	4	41	492	41	182	103	0,410
CE16-25x55*	25	55	62	23	31	39	M8 x 25	4	41	513	41	174	103	0,410
CE16-28x55*	28	55	62	23	31	39	M8 x 25	4	41	575	41	156	103	0,390
CE16-30x55*	30	55	62	23	31	39	M8 x 25	4	41	616	41	145	103	0,370
CE16-24x65*	24	65	72	23	31	39	M8 x 25	5	41	616	51	227	111	0,600
CE16-25x65*	25	65	72	23	31	39	M8 x 25	5	41	641	51	218	111	0,600
CE16-28x65*	28	65	72	23	31	39	M8 x 25	5	41	718	51	194	111	0,580
CE16-30x65*	30	65	72	23	31	39	M8 x 25	5	41	770	51	182	111	0,570
CE16-32x65*	32	65	72	23	31	39	M8 x 25	5	41	821	51	170	111	0,540
CE16-35x65*	35	65	72	23	31	39	M8 x 25	5	41	898	51	156	111	0,520
CE16-38x65*	38	65	72	23	31	39	M8 x 25	5	41	975	51	143	111	0,480
CE16-40x65*	40	65	72	23	31	39	M8 x 25	5	41	1026	51	136	111	0,460
CE16-30x80*	30	80	88	26	34	42	M8 x 25	7	41	1077	72	227	108	1,040
CE16-32x80*	32	80	88	26	34	42	M8 x 25	7	41	1150	72	213	108	1,000
CE16-35x80*	35	80	88	26	34	42	M8 x 25	7	41	1257	72	194	108	0,960
CE16-38x80*	38	80	88	26	34	42	M8 x 25	7	41	1364	72	179	108	0,930
CE16-40x80*	40	80	88	26	34	42	M8 x 25	7	41	1436	72	170	108	0,900
CE16-42x80*	42	80	88	26	34	42	M8 x 25	7	41	1509	72	162	108	0,900
CE16-45x80*	45	80	88	26	34	42	M8 x 25	7	41	1616	72	151	108	0,870
CE16-48x80*	48	80	88	26	34	42	M8 x 25	7	41	1723	72	142	108	0,850
CE16-50x80*	50	80	88	26	34	42	M8 x 25	7	41	1796	72	136	108	0,820

Allgemeine Information

General Information



Power Transmission

optibelt

optibelt S=C PLUS

optibelt Super X-POWER M=S optibelt SUPER TX M=S

Optibelt S=C PLUS – Kraftübertragung für Perfektionisten

Zwanzig Jahre ständigen Weiterentwickelns ließen ihn zu einem Keilriemen heranreifen, der präziser nicht sein kann. Die Formel S=C PLUS wurde Synonym für absolute Satzverwendbarkeit. Weltweit arbeiten Maschinen jeder Kategorie mit dem Optibelt S=C PLUS. Überall dort, wo besondere Ansprüche gestellt werden.

Warum das so ist, zeigt unter anderem die unten stehende Toleranzübersicht.

Optibelt Super X-POWER M=S und Optibelt SUPER TX M=S – die Leistungsträger

Auch diese Produkte sind uneingeschränkt satzverwendbar. Wie beim S=C PLUS sorgen das hochpräzise Herstellungsverfahren und die ausgereifte Materialtechnologie für geringste Toleranzen. Optibelt Super X-POWER M=S und SUPER TX M=S erfüllen alle weltweit gültigen Normen für Keilriemensätze.

Toleranz-Vergleich Optibelt S=C PLUS contra DIN bzw. RMA/MPTA

Hochleistungs-Schmalkeilriemen DIN 7753 Teil 1	Richtlänge L_d (mm)	S=C PLUS Toleranzen (mm)	Zulässige DIN-Toleranzen
Profil SPZ von 1212 bis 4500 mm L_d Profil SPA von 1207 bis 4500 mm L_d Profil SPB von 1250 bis 10000 mm L_d Profil SPC von 2000 bis 10000 mm L_d	> 1200 ≤ 2000 > 2000 ≤ 5000 > 5000 ≤ 8000 > 8000 ≤ 10000	± 2 ± 2 ± 4 ± 6	12 bis 20 mm 20 bis 50 mm 50 bis 80 mm 80 bis 100 mm

Klassische Keilriemen DIN 2215	Keilriemenlänge (mm)	S=C plus Toleranzen (mm)	Zulässige DIN-Toleranzen (mm)
Profil Z/10 von 1550 bis 4500 mm L_d Profil A/13 von 1200 bis 10000 mm L_d Profil B/17 von 1200 bis 10000 mm L_d Profil 20 von 1250 bis 10000 mm L_d Profil C/22 von 1200 bis 10000 mm L_d Profil 25 von 1400 bis 10000 mm L_d Profil D/32 von 2000 bis 10000 mm L_d Profil E/40 von 3000 bis 10000 mm L_d	> 1200 ≤ 1600 > 1600 ≤ 2000 > 2000 ≤ 2500 > 2500 ≤ 3150 > 3150 ≤ 4000 > 4000 ≤ 5000 > 5000 ≤ 6300 > 6300 ≤ 8000 > 8000 ≤ 10000	± 2 ± 2 ± 2 ± 2 ± 2 ± 2 ± 4 ± 4 ± 6	+ 23 / -11 + 27 / -13 + 31 / -16 + 37 / -18 + 44 / -22 + 52 / -26 + 63 / -32 + 77 / -38 + 93 / -46

Hochleistungs-Schmalkeilriemen USA-Standard RMA/MPTA

Profil 3V/ 9N von 3V 500 bis 3V 1400
Profil 5V/15N von 5V 500 bis 5V 3550
Profil 8V/25N von 8V 1000 bis 8V 3750

Das extrem günstige Verhältnis zwischen Norm- und Optibelt Toleranzen gilt auch für diese Profile. Genauere Daten entnehmen Sie bitte unseren technischen Unterlagen.

Das sind Ihre Vorteile:

- | | |
|--|----------------------------------|
| + geringste Toleranzen –
uneingeschränkt satzverwendbar | + reduzierte Vibrationen |
| + energiesparender Betrieb | + verlängerte Wartungsintervalle |
| | + längere Lebensdauer |

= optibelt Keilriemen

optibelt S=C PLUS optibelt Super X-POWER M=S optibelt SUPER TX M=S

Optibelt S=C PLUS – Power Transmission for perfectionists

Twenty years of continuous development have made a V-belt which cannot be more precise. The expression S=C PLUS has become a synonym for absolute use in matched sets. Machines of every kind are equipped worldwide with Optibelt S=C PLUS, in every location where specific requirements are demanded.

Why this is so is shown by the following tolerance list.

Optibelt Super X-POWER M=S

and Optibelt SUPER TX M=S – the bearer of performance

All belts are unrestrictedly usable in matched sets. As for the S=C PLUS the highly precise manufacturing process and the matured material technology provide for closest tolerances. Optibelt Super X-POWER M=S and SUPER TX M=S meets all valid standards worldwide for V-belt sets.

Comparison of tolerance of Optibelt S=C PLUS versus BS, DIN and RMA/MPTA Standards

Wedge belts to BS 3790 and DIN 7753 Part 1	V-belt datum length L_d (mm)	S=C PLUS tolerances (mm)	Acceptable DIN-tolerances (mm)
Section SPZ from 1212 up to 4500 mm L_d	> 1200 ≤ 2000	± 2	12 to 20 mm
Section SPA from 1207 up to 4500 mm L_d	> 2000 ≤ 5000	± 2	20 to 50 mm
Section SPB from 1250 up to 10000 mm L_d	> 5000 ≤ 8000	± 4	50 to 80 mm
Section SPC from 2000 up to 10000 mm L_d	> 8000 ≤ 10000	± 6	80 to 100 mm

V-belts to BS 3790 and DIN 2215	V-belt length (mm)	S=C PLUS tolerances (mm)	Acceptable DIN-tolerances (mm)
Section Z/10 from 1550 up to 4500 mm L_d	> 1200 ≤ 1600	± 2	+ 23 / -11
Section A/13 from 1200 up to 10000 mm L_d	> 1600 ≤ 2000	± 2	+ 27 / -13
Section B/17 from 1200 up to 10000 mm L_d	> 2000 ≤ 2500	± 2	+ 31 / -16
Section 20 from 1250 up to 10000 mm L_d	> 2500 ≤ 3150	± 2	+ 37 / -18
Section C/22 from 1200 up to 10000 mm L_d	> 3150 ≤ 4000	± 2	+ 44 / -22
Section 25 from 1400 up to 10000 mm L_d	> 4000 ≤ 5000	± 2	+ 52 / -26
Section D/32 from 2000 up to 10000 mm L_d	> 5000 ≤ 6300	± 4	+ 63 / -32
Section E/40 from 3000 up to 10000 mm L_d	> 6300 ≤ 8000	± 4	+ 77 / -38
	> 8000 ≤ 10000	± 6	+ 93 / -46

Wedge belts to USA Standard RMA/MPTA	
Section 3V/ 9N from 3V 500 up to 3V 1400 Section 5V/15N from 5V 500 up to 5V 3550 Section 8V/25N from 8V 1000 up to 8V 3750	The extremely positive ratio between standard and Optibelt tolerances is also applicable to these sections. Please take exact data from our technical literature.

These are your advantages:

- + Closest tolerances – unrestricted use in matched sets
- + Energy saving operation
- + Reduced vibration
- + Extended maintenance intervals
- + Longer belt life

= optibelt V-Belts

Allgemeine Information

Sämtliche Optibelt Keilriemen werden entsprechend den Anforderungen, für die sie ausgelegt sind, aus sorgfältig zusammengestellten Grundstoffen unter Anwendung kontinuierlich weiterentwickelter technischer Verfahren hergestellt.

Die ständige Kontrolle der Produktion, aufwändige Labortests und die gewissenhafte Prüfung der verwendeten Rohstoffe garantieren einen gleich bleibend hohen Qualitätsstandard, den Sie von jedem Optibelt Antriebselement erwarten können. Funktionssicherheit und Lebensdauer stehen dabei im Mittelpunkt aller Kriterien.

Eigenschaften

Ölbeständig

Die Ölbeständigkeit mindert den schädigenden Einfluss von Mineralölen und -fetten, sofern diese Stoffe nicht ständig und in größeren Mengen mit den Keilriemen in Berührung kommen. Tierische und pflanzliche Fette sowie wasserlösliche Kühl- und Schneidöle bewirken auf jeden Fall eine Beeinträchtigung der Lebensdauer. Bei höheren Konzentrationen empfehlen wir den Einsatz unserer speziellen Sonderausführung.

Hitzebeständig

Die Hitzebeständigkeit lässt Umgebungstemperaturen bis ca. +70 °C zu. Höhere Temperaturen führen zum frühzeitigen Altern und Verspröden der Keilriemen. Daher empfehlen wir in solchen Fällen unsere Sonderausführung XHR bzw. flankenoffene Keilriemen (Super X-POWER).

Kältebeständig

Serienmäßige Optibelt Keilriemen sind kältebeständig bis
 – 40 °C für ummantelte Keilriemen und
 – 30 °C für flankenoffene Keilriemen.
 In Grenzbereichen sind praktische Erprobungen erforderlich.

Elektrisch leitfähig

Der Einsatz von elektrisch leitfähigen Keilriemen erfordert eine Überprüfung der vorgeschriebenen Eigenschaften gemäß ISO 1813. Mit unserem Abnahmeprüfzeugnis nach EN 10204 „3.1.B“ weisen wir die elektrische Leitfähigkeit nach.

Für den Mehraufwand berechnen wir einen Aufpreis von 20%. Wir empfehlen dringend, elektrisch leitfähige Keilriemen stets gesondert zu bestellen.

Zwischenlängen

können bei ummantelten Keilriemen gefertigt werden. Im Längenbereich bis 1800 mm prüfen wir auf Anfrage die Liefermöglichkeit. Voraussetzung ist die Abnahme produktionsbedingter Mindestmengen. Wir behalten uns Mehr- oder Minderlieferungen vor.

Die Einhaltung von Sondertoleranzen wird nach Aufwand berechnet.

Sonderausführungen

Beispiele von Sonderausführungen, die gegen Aufpreis geliefert werden können:

laufruhig selektiert – LR	20 %
extra ölbeständig	50 %
extra hitzebeständig – XHR	20 %
Keilriemen mit Auflage – PKR	200 %

Aufpreise für Sonderausführungen anderer Art als oben aufgeführt bitten wir anzufragen.

Sonderausführungen (ummantelte Keilriemen)

Bei Unterschreitung der Standard-Abnahmemenge (3 Produktionssätze) werden Aufpreise für Mindermengen berechnet.

Es gilt folgende Regelung:

2 Produktionssätze:	20 % Aufpreis
1 Produktionssatz:	40 % Aufpreis

Für einige Sonderausführungen können je nach Konstruktion und Längenbereich Mindest-Abnahmemengen notwendig sein, die von den profilbezogenen Angaben abweichen.

Mehrrillige Antriebe

erfordern die Bestellung von Keilriemensätzen, die den Norm-Vorschriften entsprechend ausgemessen sein müssen; es sei denn, Sie verwenden Optibelt S=C PLUS oder Super X-POWER M=S Keilriemen. Bei Ausfall eines Keilriemens muss der gesamte Satz erneuert werden.

Abkürzungen

L_i	= Innenlänge
L_a	= Außenlänge
L_w/L_p	= Wirklänge
L_d	= Richtlänge (Datum length)
Richtlänge L_d	= Wirklänge L_w/L_p

Verkaufshilfen

Gegen Erstattung eines Kostenbeitrages liefern wir Ihnen:

Riemenvorspannungs-Messgeräte

zur Ermittlung der korrekten Vorspannung an Riemenantrieben

Messlatte

zur Ermittlung der Länge von Keilriemen bis 2500 mm

Technische Handbücher

zur Antriebsberechnung

Beratung und Antriebsberechnung

Unsere Ingenieure der Fachabteilung Anwendungstechnik unterstützen Sie gerne bei Ihren Verkaufsbemühungen.

Standard-Bündelungen für Optibelt Keilriemen

Profil	bis 2300 mm (nicht geschlungen)	bis 5000 mm (3 Ringe/Stück)	ab 5000 mm (5 Ringe/Stück)
SPZ; XPZ; 3V/9N; 3VX	25 Stück	10 Stück	—
SPA; XPA	25 Stück	10 Stück	—
SPB; XPB; 5V/15N; 5VX	10 Stück	10 Stück	5 Stück
SPC; XPC	10 Stück	5 Stück	3 Stück
8V/25N	—	1 Stück	1 Stück
5	25 Stück	—	—
Y/6	25 Stück	—	—
8	25 Stück	—	—
Z/10; ZX/X10	25 Stück	10 Stück	—
A/13; AX/X13	25 Stück	10 Stück	10 Stück
B/17; BX/X17	10 Stück	10 Stück	5 Stück
20	10 Stück	5 Stück	3 Stück
C/22; CX/X22	10 Stück	5 Stück	3 Stück
25	10 Stück	5 Stück	3 Stück
D/32	1 Stück	1 Stück	1 Stück
E/40	—	1 Stück	1 Stück

General Information

All Optibelt V-belts are manufactured with carefully chosen raw materials utilising continually updated manufacturing methods.

The modernisation of production processes, large scale laboratory testing, and the careful control of the basic materials will guarantee a consistent quality for every Optibelt power transmission component.

Product function, efficiency and durability are of major importance to Optibelt.

Characteristics

Oil resistant

The oil resistant cover of the belt protects it from contamination by mineral oil / grease splash. Contamination by animal or vegetable oil or water solvent cutting oil will reduce belt life. In extreme cases the use of our special construction is recommended.

Heat resistant

Standard construction Optibelts will operate in ambient temperatures up to +70 °C / +158 °F.

Higher ambient temperatures will lead to premature ageing and subsequent belt failure. In this case our special construction XHR or Super X-POWER is recommended.

Cold resistant

Standard construction Optibelt V-belts will perform satisfactorily in ambient temperatures down to

–40 °C / –40 °F for wrapped construction and

–30 °C / –22 °F for raw edge construction.

Under critical conditions practical tests are necessary.

Anti static

In order to comply with product safety requirements the specific anti static properties of any V-belts must be tested to ISO 1813. A test certificate will be issued and a 20% surcharge will be applied.

Anti static V-belts should be specified separately to ensure that the correct certification is carried out.

Intermediate lengths

can be produced for wrapped V-belts except for lengths of up to 1800 mm, where we have to check our possibilities on request. A minimum quantity for each length is required. We reserve the right of over- and under supplies.

The compliance with special tolerances is charged on a time and material basis.

Special Constructions

The following are examples of surcharges applicable to special constructions.

Smooth running – LR	20 %
Extra oil resistant	50 %
Extra heat resistant – XHR	20 %
V-belts with patterned top surface – PKR	200 %

Prices for other constructions on request. Observance of special tolerances will be charged according to actual cost.

Non standard lengths and special constructions for wrapped V-belts

In the event that fewer production sets than normal are required for a particular special construction wrapped belt (normal 3 production sets) then the following surcharges apply:

2 production sets	20% surcharge
1 production set	40% surcharge

Please note that minimum production set quantities may vary for certain special construction belts. If in doubt ask your Optibelt contact.

Multiple Belt Drives

Requirements for drives using sets of belts often demand belt measurement to form the sets. Optibelt S=C PLUS and Super X-POWER M=S belts do not require belt measurement or re-measurement to form sets.

Abbreviations

L_i	= Inside length
L_a	= Outside length
L_w/L_p	= Pitch length
L_d	= Datum length

Datum length L_d = Pitch length L_w/L_p

Technical Accessories

The following are available at a nominal charge:

Measuring gauges

for approximate length measurement of V-belts up to 2500 mm.

Tension gauges

for the setting of the correct static tension of V-belts.

Technical Manuals

for drive design.

Advice and Drive Design

Our Applications Engineers are always available to give advice and to design drives. This service is free of charge.

Standard bundle quantities for Optibelt V-belts

Section	up to 2300 mm (not coiled)	up to 5000 mm (3 coils = 1 piece)	over 5000 mm (5 coils = 1 piece)
SPZ; XPZ; 3V/9N; 3VX	25 pieces	10 pieces	—
SPA; XPA	25 pieces	10 pieces	—
SPB; XPB; 5V/15N; 5VX	10 pieces	10 pieces	5 pieces
SPC; XPC	10 pieces	5 pieces	3 pieces
8V/25N	—	1 piece	1 piece
5	25 pieces	—	—
Y/6	25 pieces	—	—
8	25 pieces	—	—
Z/10; ZX/X10	25 pieces	10 pieces	—
A/13; AX/X13	25 pieces	10 pieces	10 pieces
B/17; BX/X17	10 pieces	10 pieces	5 pieces
20	10 pieces	5 pieces	3 pieces
C/22; CX/X22	10 pieces	5 pieces	3 pieces
25	10 pieces	5 pieces	3 pieces
D/32	1 piece	1 piece	1 piece
E/40	—	1 piece	1 piece

BQ = Bundle quantity

Umrechnungswerte

Optibelt SK und Optibelt RED POWER II Hochleistungs-Schmalkeilriemen DIN 7753 Teil 1 / ISO 4184

Profil	Querschnitt b x h ≈	Untere Riemen- breite b _u ≈	Richt- breite b _d	Riemenlängen				Empfohlener Mindest- Scheibendurchmesser (mm)	Meter- gewicht (≈ kg/m)	
				Nenn- länge	Außenlänge L _a	Richtlänge L _d	Innenlänge L _i			
SPZ	9,7 x 8	4,2	8,5	Richt- länge L _d	L _a ≈ L _d + 13 L _a ≈ L _i + 51	—	L _i ≈ L _d - 38 L _i ≈ L _a - 51	Richt- durch- messer d _d	63	0,074
SPA	12,7 x 10	5,8	11,0		L _a ≈ L _d + 18 L _a ≈ L _i + 63	—	L _i ≈ L _d - 45 L _i ≈ L _a - 63		90	0,123
SPB	16,3 x 13	7,3	14,0		L _a ≈ L _d + 22 L _a ≈ L _i + 82	—	L _i ≈ L _d - 60 L _i ≈ L _a - 82		140	0,195
SPC	22,0 x 18	9,6	19,0		L _a ≈ L _d + 30 L _a ≈ L _i + 113	—	L _i ≈ L _d - 83 L _i ≈ L _a - 113		224	0,377

Optibelt SK und Optibelt RED POWER II Hochleistungs-Schmalkeilriemen USA-Standard RMA/MPTA

3V/9N	9,0 x 8	4,2	—	Außen- länge L _a	—	L _d ≈ L _a - 4*	L _i ≈ L _a - 42	Außen- durch- messer d _a	63	0,074
5V/15N	15,0 x 13	7,3	—		—	L _d ≈ L _a - 11*	L _i ≈ L _a - 71		140	0,195
8V/25N	25,0 x 23	9,6	—		—	—	L _i ≈ L _a - 120		315	0,575

* Der Umrechnungswert L_d auf L_a wird angewendet, wenn ein Profil nach DIN 7753 Teil 1 bzw. ISO 4184 durch ein entsprechendes Profil nach RMA/MPTA ausgetauscht werden soll.

Optibelt Super X-POWER M=S Schmalkeilriemen – flankenoffen, formgezahnt – DIN 7753 Teil 1

XPZ	9,7 x 8	4,2	8,5	Richt- länge L _d	L _a ≈ L _d + 13 L _a ≈ L _i + 51	—	L _i ≈ L _d - 38 L _i ≈ L _a - 51	Richt- durch- messer d _d	56	0,065
XPA	12,7 x 10	5,8	11,0		L _a ≈ L _d + 18 L _a ≈ L _i + 63	—	L _i ≈ L _d - 45 L _i ≈ L _a - 63		71	0,111
XPB	16,3 x 13	7,3	14,0		L _a ≈ L _d + 22 L _a ≈ L _i + 82	—	L _i ≈ L _d - 60 L _i ≈ L _a - 82		112	0,183
XPC	22,0 x 18	9,6	19,0		L _a ≈ L _d + 30 L _a ≈ L _i + 113	—	L _i ≈ L _d - 83 L _i ≈ L _a - 113		180	0,340

Optibelt Super X-POWER M=S Schmalkeilriemen – flankenoffen, formgezahnt – USA-Standard RMA/MPTA

3VX/9NX	9,0 x 8	4,2	—	Außen- länge L _a	—	L _d ≈ L _a - 4*	L _i ≈ L _a - 42	Außen- durch- messer d _a	56	0,065
5VX/15NX	15,0 x 13	7,3	—		—	L _d ≈ L _a - 11*	L _i ≈ L _a - 71		112	0,183

* Der Umrechnungswert L_d auf L_a wird angewendet, wenn ein Profil nach DIN 7753 Teil 1 bzw. ISO 4184 durch ein entsprechendes Profil nach RMA/MPTA ausgetauscht werden soll.

Optibelt SUPER TX M=S Keilriemen – flankenoffen, formgezahnt

ZX/X10	10,0 x 6	5,9	8,5	Richt- länge L _d	L _a ≈ L _i + 38 L _a ≈ L _d + 16	—	L _i ≈ L _d - 22 L _i ≈ L _a - 38	Richt- durch- messer d _d	40	0,062
AX/X13	13,0 x 8	7,5	11,0		L _a ≈ L _i + 50 L _a ≈ L _d + 20	—	L _i ≈ L _d - 30 L _i ≈ L _a - 50		63	0,099
BX/X17	17,0 x 11	9,4	14,0		L _a ≈ L _i + 69 L _a ≈ L _d + 29	—	L _i ≈ L _d - 40 L _i ≈ L _a - 69		90	0,165
CX/X22	22,0 x 14	12,3	19,0		L _a ≈ L _i + 88 L _a ≈ L _d + 30	—	L _i ≈ L _d - 58 L _i ≈ L _a - 88		140	0,276

Optibelt VB Klassische Keilriemen DIN 2215 / ISO 4184

5	5,0 x 3	2,8	4,2	Richt- länge L _d	L _a ≈ L _i + 19 L _a ≈ L _d + 8	L _d ≈ L _i + 11 L _d ≈ L _a - 8	—	Richt- durch- messer d _d	20	0,018
Y/6	6,0 x 4	3,3	5,3		L _a ≈ L _i + 25 L _a ≈ L _d + 10	L _d ≈ L _i + 15 L _d ≈ L _a - 10	—		28	0,026
8	8,0 x 5	4,5	6,7		L _a ≈ L _i + 31 L _a ≈ L _d + 12	L _d ≈ L _i + 19 L _d ≈ L _a - 12	—		40	0,042
Z/10	10,0 x 6	5,9	8,5		L _a ≈ L _i + 38 L _a ≈ L _d + 16	L _d ≈ L _i + 22 L _d ≈ L _a - 16	—		50	0,064
A/13	13,0 x 8	7,5	11,0		L _a ≈ L _i + 50 L _a ≈ L _d + 20	L _d ≈ L _i + 30 L _d ≈ L _a - 20	—		71	0,109
B/17	17,0 x 11	9,4	14,0		L _a ≈ L _i + 69 L _a ≈ L _d + 29	L _d ≈ L _i + 40 L _d ≈ L _a - 29	—		112	0,196
20	20,0 x 12,5	11,4	17,0		L _a ≈ L _i + 79 L _a ≈ L _d + 31	L _d ≈ L _i + 48 L _d ≈ L _a - 31	—		160	0,266
C/22	22,0 x 14	12,3	19,0		L _a ≈ L _i + 88 L _a ≈ L _d + 30	L _d ≈ L _i + 58 L _d ≈ L _a - 30	—		180	0,324
25	25,0 x 16	14,0	21,0		L _a ≈ L _i + 100 L _a ≈ L _d + 39	L _d ≈ L _i + 61 L _d ≈ L _a - 39	—		250	0,420
D/32	32,0 x 20	18,2	27,0		L _a ≈ L _i + 126 L _a ≈ L _d + 51	L _d ≈ L _i + 75 L _d ≈ L _a - 51	—		355	0,668
E/40	40,0 x 25	22,8	32,0		L _a ≈ L _i + 157 L _a ≈ L _d + 77	L _d ≈ L _i + 80 L _d ≈ L _a - 77	—		500	0,958

Umrechnungswerte

Optibelt KB und Optibelt RED POWER II Kraftbänder mit Hochleistungs-Schmalkeilriemen ISO 5290 / USA-Standard RMA/MPTA

Profil	Höhe $h \approx$	Untere Riemenbreite $b_u \approx$ des Einzelriemens	Riemenlängen				Empfohlener Mindest- Scheibendurchmesser (mm)		Meter- gewicht für 1 Rippe (\approx kg/m)	
			Nenn- länge	Außenlänge L_a	Richtlänge L_d	Innenlänge L_i	Außen- durch- messer d_a			
3V/9J	9,9	4,2	Außenlänge L_a	—	—	$L_i \approx L_a - 42$			67	0,122
5V/15J	15,1	7,3		—	—	$L_i \approx L_a - 71$	160	0,252		
8V/25J	25,5	9,6		—	—	$L_i \approx L_a - 120$				

Optibelt KB und Optibelt RED POWER II Kraftbänder mit Hochleistungs-Schmalkeilriemen

Profil	Höhe $h \approx$	Untere Riemenbreite $b_u \approx$	Richt- länge L_d	$L_a \approx L_d + 13$	—	—	Richt- durch- messer d_d		
SPZ	10,5	5,4		$L_a \approx L_d + 18$	—	—		80	0,120
SPA	12,5	7,0		$L_a \approx L_d + 22$	—	—		112	0,166
SPB	15,6	8,8		$L_a \approx L_d + 24$	—	—		180	0,261
SPC	22,6	9,3				250	0,555		

Optibelt KBX Kraftbänder mit Hochleistungs-Schmalkeilriemen

Profil	Höhe $h \approx$	Untere Riemenbreite $b_u \approx$	Außenlänge L_a	—	—	$L_i \approx L_a - 42$	Außen- durch- messer d_a		
3VX/9JX	9,9	4,2		—	—	$L_i \approx L_a - 71$		67	0,122
5VX/15JX	15,1	7,3	—	—		160	0,252		

Optibelt KB Kraftbänder USA-Standard RMA/MPTA

Profil	Höhe $h \approx$	Untere Riemenbreite $b_u \approx$	Innenlänge L_i	$L_a \approx L_i + 36$	$L_d \approx L_i + 30$	—	Außen- durch- messer d_a		
A	9,9	7,5		$L_a \approx L_i + 62$	$L_d \approx L_i + 40$	—		80	0,163
B	13,0	9,4		$L_a \approx L_i + 75$	$L_d \approx L_i + 58$	—		125	0,266
C	16,2	12,3		$L_a \approx L_i + 111$	$L_d \approx L_i + 75$	—		200	0,447
D	22,4	18,2				355	0,798		

Optibelt KB Kraftbänder USA-Standard ASAE S 211.5

Profil	Höhe $h \approx$	Untere Riemenbreite $b_u \approx$	Außenlänge L_a	—	—	$L_i \approx L_a - 36$	Außen- durch- messer d_a				
HA	9,9	7,5		—	—	$L_i \approx L_a - 62$		80	0,163		
HB	13,0	9,4		—	—	$L_i \approx L_a - 75$				125	0,266
HC	16,2	12,3		—	—	$L_i \approx L_a - 111$					
HD	22,4	18,2	—	—		355	0,798				

Die Breite der Kraftbänder ist von der Anzahl der Rippen abhängig.

Optibelt DK Doppelkeilriemen DIN 7722 / ISO 5289

Profil	Querschnitt $b \times h \approx$	Untere Riemen- breite $b_u \approx$	Nenn- länge	Riemenlängen	Empfohlener Mindest- Scheibendurchmesser (mm)	Meter- gewicht (\approx kg/m)
AA/HAA	13 x 10	—	Bezugs- länge	Bezugslänge \approx Mittellänge - 4	Außen- durch- messer d_a	80
BB/HBB	17 x 13	—		Bezugslänge \approx Mittellänge - 8		125
CC/HCC	22 x 17	—		Bezugslänge \approx Mittellänge + 3		224
DD/HDD	32 x 25	—		Bezugslänge \approx Mittellänge		355

Optibelt DK Doppelkeilriemen – Sonderprofile

Profil	Querschnitt $b \times h \approx$	Untere Riemen- breite $b_u \approx$	Bezugs- länge	Bezugslänge \approx Mittellänge	Außen- durch- messer d_a	
22 x 22	22 x 22	—		Bezugslänge \approx Mittellänge		280
25 x 22	25 x 22	—		280	0,625	

Richtlänge $L_d =$ Wirklänge L_w/L_p

Technical Information

Optibelt SK and Optibelt RED POWER II Wedge Belts to BS 3790 and DIN 7753 Part 1 / ISO 4184

Section	Dimension $W \times H \approx$	Section base width $W_U \approx$	Pitch width l_d	Belt lengths				Recommended minimum pulley diameter (mm)	Belt weight (\approx kg/m)	
				Nominal length	Outside length L_a	Datum length L_d	Inside length L_i			
SPZ	9,7 x 8	4,2	8,5	Datum length L_d	$L_a \approx L_d + 13$ $L_a \approx L_i + 51$	—	$L_i \approx L_d - 38$ $L_i \approx L_a - 51$	Datum diameter d_d	63	0,074
SPA	12,7 x 10	5,8	11,0		$L_a \approx L_d + 18$ $L_a \approx L_i + 63$	—	$L_i \approx L_d - 45$ $L_i \approx L_a - 63$		90	0,123
SPB	16,3 x 13	7,3	14,0		$L_a \approx L_d + 22$ $L_a \approx L_i + 82$	—	$L_i \approx L_d - 60$ $L_i \approx L_a - 82$		140	0,195
SPC	22,0 x 18	9,6	19,0		$L_a \approx L_d + 30$ $L_a \approx L_i + 113$	—	$L_i \approx L_d - 83$ $L_i \approx L_a - 113$		224	0,377

Optibelt SK and Optibelt RED POWER II Wedge Belts to USA Standard RMA/MPTA

3V/9N	9,0 x 8	4,2	—	Outside length L_a	—	$L_d \approx L_a - 4*$	$L_i \approx L_a - 42$	Outside diameter d_a	63	0,074
5V/15N	15,0 x 13	7,3	—		—	$L_d \approx L_a - 11*$	$L_i \approx L_a - 71$		140	0,195
8V/25N	25,0 x 23	9,6	—		—	—	$L_i \approx L_a - 120$		315	0,575

* The value for the difference between L_d and L_a is necessary if it is required to substitute a belt section to BS 3790:1991 or DIN 7753 Part 1 for a belt section to RMA/MPTA.

Optibelt Super X-POWER M=S Moulded Cogged, Raw Edge Wedge Belts – DIN 7753 Part 1

XPZ	9,7 x 8	4,2	8,5	Datum length L_d	$L_a \approx L_d + 13$ $L_a \approx L_i + 51$	—	$L_i \approx L_d - 38$ $L_i \approx L_a - 51$	Datum diameter d_d	56	0,065
XPA	12,7 x 10	5,8	11,0		$L_a \approx L_d + 18$ $L_a \approx L_i + 63$	—	$L_i \approx L_d - 45$ $L_i \approx L_a - 63$		71	0,111
XPB	16,3 x 13	7,3	14,0		$L_a \approx L_d + 22$ $L_a \approx L_i + 82$	—	$L_i \approx L_d - 60$ $L_i \approx L_a - 82$		112	0,183
XPC	22,0 x 18	9,6	19,0		$L_a \approx L_d + 30$ $L_a \approx L_i + 113$	—	$L_i \approx L_d - 83$ $L_i \approx L_a - 113$		180	0,340

Optibelt Super X-POWER M=S Moulded Cogged, Raw Edge Wedge Belts – USA Standard RMA/MPTA

3VX/9NX	9,0 x 8	4,2	—	Outside length L_a	—	$L_d \approx L_a - 4*$	$L_i \approx L_a - 42$	Outside diameter d_a	56	0,065
5VX/15NX	15,0 x 13	7,3	—		—	$L_d \approx L_a - 11*$	$L_i \approx L_a - 71$		112	0,183

* The value for the difference between L_d and L_a is necessary if it is required to substitute a belt section to BS 3790:1991 or DIN 7753 Part 1 for a belt section to RMA/MPTA.

Optibelt SUPER TX M=S Moulded Cogged, Raw Edge Wedge Belts

ZX/X10	10,0 x 6	5,9	8,5	Datum length L_d	$L_a \approx L_i + 38$ $L_a \approx L_d + 16$	—	$L_i \approx L_d - 22$ $L_i \approx L_a - 38$	Datum diameter d_d	40	0,062
AX/X13	13,0 x 8	7,5	11,0		$L_a \approx L_i + 50$ $L_a \approx L_d + 20$	—	$L_i \approx L_d - 30$ $L_i \approx L_a - 50$		63	0,099
BX/X17	17,0 x 11	9,4	14,0		$L_a \approx L_i + 69$ $L_a \approx L_d + 29$	—	$L_i \approx L_d - 40$ $L_i \approx L_a - 69$		90	0,165
CX/X22	22,0 x 14	12,3	19,0		$L_a \approx L_i + 88$ $L_a \approx L_d + 30$	—	$L_i \approx L_d - 58$ $L_i \approx L_a - 88$		140	0,276

Optibelt VB V-Belts to BS 3790 and DIN 2215 / ISO 4184

5	5,0 x 3	2,8	4,2	Datum length L_d	$L_a \approx L_i + 19$ $L_a \approx L_d + 8$	$L_d \approx L_i + 11$ $L_d \approx L_a - 8$	—	Datum diameter d_d	20	0,018
Y/6	6,0 x 4	3,3	5,3		$L_a \approx L_i + 25$ $L_a \approx L_d + 10$	$L_d \approx L_i + 15$ $L_d \approx L_a - 10$	—		28	0,026
8	8,0 x 5	4,5	6,7		$L_a \approx L_i + 31$ $L_a \approx L_d + 12$	$L_d \approx L_i + 19$ $L_d \approx L_a - 12$	—		40	0,042
Z/10	10,0 x 6	5,9	8,5		$L_a \approx L_i + 38$ $L_a \approx L_d + 16$	$L_d \approx L_i + 22$ $L_d \approx L_a - 16$	—		50	0,064
A/13	13,0 x 8	7,5	11,0		$L_a \approx L_i + 50$ $L_a \approx L_d + 20$	$L_d \approx L_i + 30$ $L_d \approx L_a - 20$	—		71	0,109
B/17	17,0 x 11	9,4	14,0		$L_a \approx L_i + 69$ $L_a \approx L_d + 29$	$L_d \approx L_i + 40$ $L_d \approx L_a - 29$	—		112	0,196
20	20,0 x 12,5	11,4	17,0		$L_a \approx L_i + 79$ $L_a \approx L_d + 31$	$L_d \approx L_i + 48$ $L_d \approx L_a - 31$	—		160	0,266
C/22	22,0 x 14	12,3	19,0		$L_a \approx L_i + 88$ $L_a \approx L_d + 30$	$L_d \approx L_i + 58$ $L_d \approx L_a - 30$	—		180	0,324
25	25,0 x 16	14,0	21,0		$L_a \approx L_i + 100$ $L_a \approx L_d + 39$	$L_d \approx L_i + 61$ $L_d \approx L_a - 39$	—		250	0,420
D/32	32,0 x 20	18,2	27,0		$L_a \approx L_i + 126$ $L_a \approx L_d + 51$	$L_d \approx L_i + 75$ $L_d \approx L_a - 51$	—		355	0,668
E/40	40,0 x 25	22,8	32,0		$L_a \approx L_i + 157$ $L_a \approx L_d + 77$	$L_d \approx L_i + 80$ $L_d \approx L_a - 77$	—		500	0,958

Technical Information

Optibelt KB and Optibelt RED POWER II Kraftbands with Wedge Belts to ISO 5290 / USA Standard RMA/MPTA

Section	Height $h \approx$	Section base width $W_u \approx$	Belt length				Recommended minimum pulley diameter (mm)		Belt weight per rib (\approx kg/m)
			Nominal length	Outside length L_a	Datum length L_d	Inside length L_i			
3V/9J; 3VX/9JX	9,9	4,2	Outside length L_a	—	—	$L_i \approx L_a - 42$	Outside diameter d_a	67	0,122
5V/15J; 5VX/15JX	15,1	7,3		—	—	$L_i \approx L_a - 71$		160	0,252
8V/25J	25,5	9,6		—	—	$L_i \approx L_a - 120$		315	0,693

Optibelt KB and Optibelt RED POWER II Kraftbands with Wedge Belts

Section	Height $h \approx$	Section base width $W_u \approx$	Datum length L_d	$L_a \approx L_d + 13$	—	—	Datum diameter d_d	80	0,120
SPA	12,5	7,0		$L_a \approx L_d + 18$	—	—		112	0,166
SPB	15,6	8,8		$L_a \approx L_d + 22$	—	—		180	0,261
SPC	22,6	9,3		$L_a \approx L_d + 24$	—	—		250	0,555

Optibelt KBX Kraftbands with Wedge Belts

Section	Height $h \approx$	Section base width $W_u \approx$	Outside length L_a	—	—	$L_i \approx L_a - 42$	Outside diameter d_a	67	0,122
5VX/15JX	15,1	7,3		—	—	$L_i \approx L_a - 71$		160	0,252

Optibelt KB Kraftbands with V-Belts to USA Standard RMA/MPTA

Section	Height $h \approx$	Section base width $W_u \approx$	Inside length L_i	$L_a \approx L_i + 36$	$L_d \approx L_i + 30$	—	Outside diameter d_a	80	0,163
B	13,0	9,4		$L_a \approx L_i + 62$	$L_d \approx L_i + 40$	—		125	0,266
C	16,2	12,3		$L_a \approx L_i + 75$	$L_d \approx L_i + 58$	—		200	0,447
D	22,4	18,2		$L_a \approx L_i + 111$	$L_d \approx L_i + 75$	—		355	0,798

Optibelt KB Kraftbands with V-Belts to USA Standard ASAE S 211.5

Section	Height $h \approx$	Section base width $W_u \approx$	Outside length L_a	—	—	$L_i \approx L_a - 36$	Outside diameter d_a	80	0,163
HB	13,0	9,4		—	—	$L_i \approx L_a - 62$		125	0,266
HC	16,2	12,3		—	—	$L_i \approx L_a - 75$		200	0,447
HD	22,4	18,2		—	—	$L_i \approx L_a - 111$		355	0,798

The belt width of a kraftband depends on the number of belts incorporated.

Optibelt DK Double V-Belts to ISO 5289

Section	Dimension $W \times H \approx$	Section base width $b_u \approx$	Nominal length	Belt length	Recommended minimum pulley diameter (mm)	Belt weight (\approx kg/m)
AA/HAA	13 x 10	—	Reference length	Reference length \approx middle length - 4	Outside diameter d_a	80
BB/HBB	17 x 13	—		Reference length \approx middle length - 8		125
CC/HCC	22 x 17	—		Reference length \approx middle length + 3		224
DD/HDD	32 x 25	—		Reference length \approx middle length		355

Optibelt DK Double V-Belts – Special Sections

Section	Dimension $W \times H \approx$	Section base width $b_u \approx$	Reference length	Reference length \approx middle length	Outside diameter d_a	280
25 x 22	25 x 22	—		Reference length \approx middle length		280

Datum length $L_d =$ Pitch length L_w/L_p

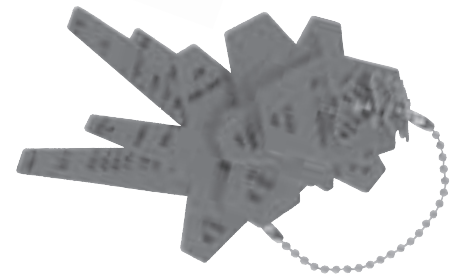

HTD®, STD® sind eingetragene Warenzeichen. *HTD®, STD® are registered trademarks.*

Nachdruck, auch auszugsweise, verboten. *Reproduction, in full or part is forbidden.*

Zuwerhandlungen werden urheberrechtlich verfolgt. *Any infringement will be prosecuted under the copyright act law.*

Irrtum sowie Änderungen durch technischen Fortschritt vorbehalten. *Subject to correction or change without notice due to technological progress.*

Bezüglich der Haftung und Lieferung verweisen wir auf unsere allgemeinen Verkaufsbedingungen.

Concerning liability and delivery refer to our general terms and conditions.

Die allgemeinen Verkaufsbedingungen sind in der jeweils gültigen Fassung auf der Internetseite unter www.optibelt.com einzusehen. Auf Wunsch können Ihnen diese zugesandt werden.
The latest version of the general conditions of sale can be viewed on the Internet under www.optibelt.com. We can send it to you on request.



optibelt VB
Klassische Keilriemen
Classical V-belts

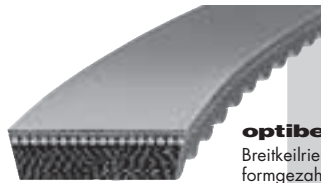

optibelt SUPER VX
Breitkeilriemen, flankenoffen,
formgezahnt
Variable speed belts,
raw edge, moulded cogged

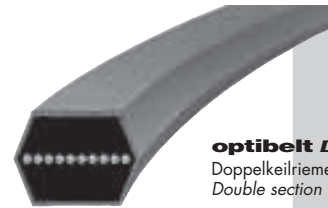

optibelt DK
Doppelkeilriemen
Double section V-belts

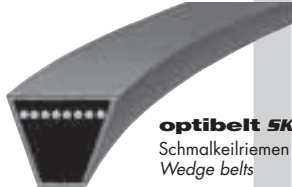

optibelt SK
Schmalkeilriemen
Wedge belts



optibelt SUPER DVX
Doppel-Breitkeilriemen,
flankenoffen, formgezahnt
Double section variable speed
belts, raw edge, moulded cogged

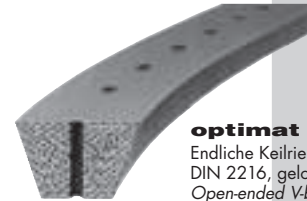

optimat OE
Endliche Keilriemen
DIN 2216, gelocht
Open-ended V-belt, punched



optibelt RED POWER II
Hochleistungs-Schmalkeilriemen,
wartungsfrei
High performance wedge belts,
service-free

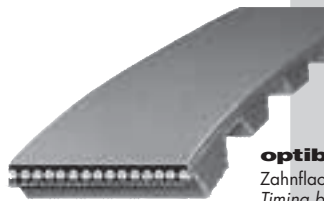

optibelt ZR
Zahnflachriemen
Timing belts



optibelt RR
Kunststoffrundriemen
Plastic round section
belting



optibelt Super X-POWER M=5
Keilriemen, flankenoffen, formgezahnt
V-belts, raw edge, moulded cogged

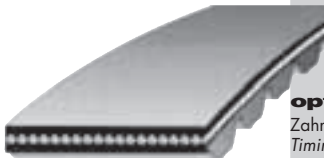

optibelt OMEGA
Zahnflachriemen, wartungsfrei
Timing belts, service-free

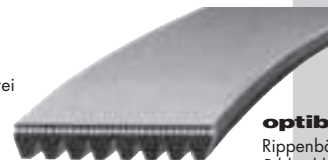

optibelt RB
Rippenbänder
Ribbed belts



optibelt KB
Kraftbänder
Kraftbands



optibelt OMEGA HL
optibelt OMEGA HP
Hochleistungs-Zahnflachriemen,
wartungsfrei
High performance timing belts,
service-free

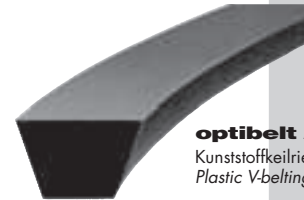

optibelt KK
Kunststoffkeilriemen
Plastic V-belt

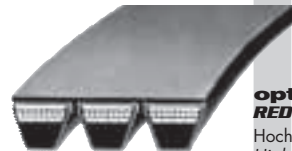

optibelt KB
RED POWER II
Hochleistungs-Kraftbänder
High performance kraftbands

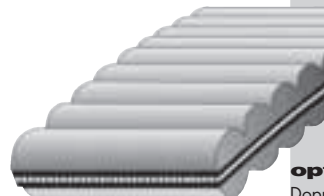

optibelt HTD® D
Doppel-Zahnflachriemen
Double section timing belts



optibelt KS
Keilrillenscheiben
V-grooved pulleys

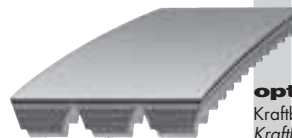

optibelt KBX
Kraftbänder, flankenoffen
Kraftbands, raw edge



optibelt ALPHA
optibelt ALPHA linear/V
optibelt ALPHAflex
Zahnflachriemen aus Polyurethan
Polyurethane timing belts

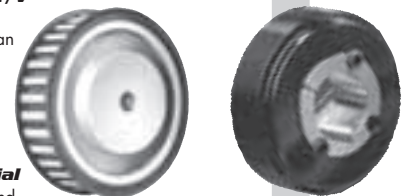

optibelt ZRS
Zahnriemenscheiben
Timing belt pulleys

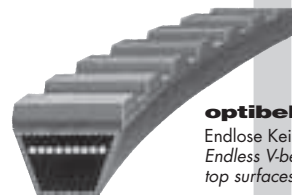

optibelt PKR
Endlose Keilriemen mit Auflage
Endless V-belts with special
top surfaces

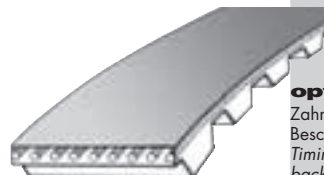

optibelt ALPHA Spezial
Zahnflachriemen mit Nocken und
Beschichtungen
Timing belts with cleats and
back coverings

optibelt RB5
Rippenbandscheiben
Ribbed belt pulleys